



US00D606835S

(12) **United States Design Patent**
Robinson

(10) **Patent No.:** **US D606,835 S**

(45) **Date of Patent:** **** Dec. 29, 2009**

(54) **SCREWDRIVER HEAD**

6,973,858 B2 * 12/2005 Huang 81/177.85
7,437,979 B1 * 10/2008 Wang 81/436

(75) Inventor: **Glenn Robinson**, Coral Springs, FL
(US)

* cited by examiner

(73) Assignee: **IBT Holdings, LLC**, Coral Springs, FL
(US)

Primary Examiner—Philip S Hyder
(74) *Attorney, Agent, or Firm*—Steven M. Greenberg, Esq.;
Carey, Rodriguez, Greenberg & Paul, LLP

(**) Term: **14 Years**

(57) **CLAIM**

(21) Appl. No.: **29/317,988**

The ornamental design for a screwdriver head, as shown and described.

(22) Filed: **May 12, 2008**

(51) **LOC (9) Cl.** **08-04**

(52) **U.S. Cl.** **D8/86**

(58) **Field of Classification Search** D8/70,
D8/82, 83, 84, 85, 86; 81/436, 437, 438,
81/439, 440

See application file for complete search history.

DESCRIPTION

FIG. 1 is a front, right, top perspective of a screwdriver head according to my new design.

FIG. 2 is a rear, left, bottom perspective of the screwdriver head thereof.

FIG. 3 is a front view of the screwdriver head thereof.

FIG. 4 is a rear view of the screwdriver head thereof.

FIG. 5 is a left-side view of the screwdriver head thereof.

FIG. 6 is a right-side view of the screwdriver head thereof.

FIG. 7 is a top view of the screwdriver head thereof; and,

FIG. 8 is a bottom view of the screwdriver head thereof.

This design is directed to a screwdriver head. The broken lines are for illustrative purposes only and form no part of the claimed design.

(56) **References Cited**

U.S. PATENT DOCUMENTS

3,114,401	A *	12/1963	Johnson	81/438
4,056,020	A *	11/1977	Coviello	81/177.2
4,779,493	A *	10/1988	White	81/438
4,880,122	A *	11/1989	Martindell	211/70.6
5,533,429	A *	7/1996	Kozak	81/439
D410,372	S *	6/1999	Strauch	D8/86
6,193,242	B1 *	2/2001	Robison	279/137
D462,596	S *	9/2002	Fruhm	D8/86
6,745,652	B2 *	6/2004	Chen	81/438
6,883,406	B2 *	4/2005	Yang	81/438

1 Claim, 8 Drawing Sheets

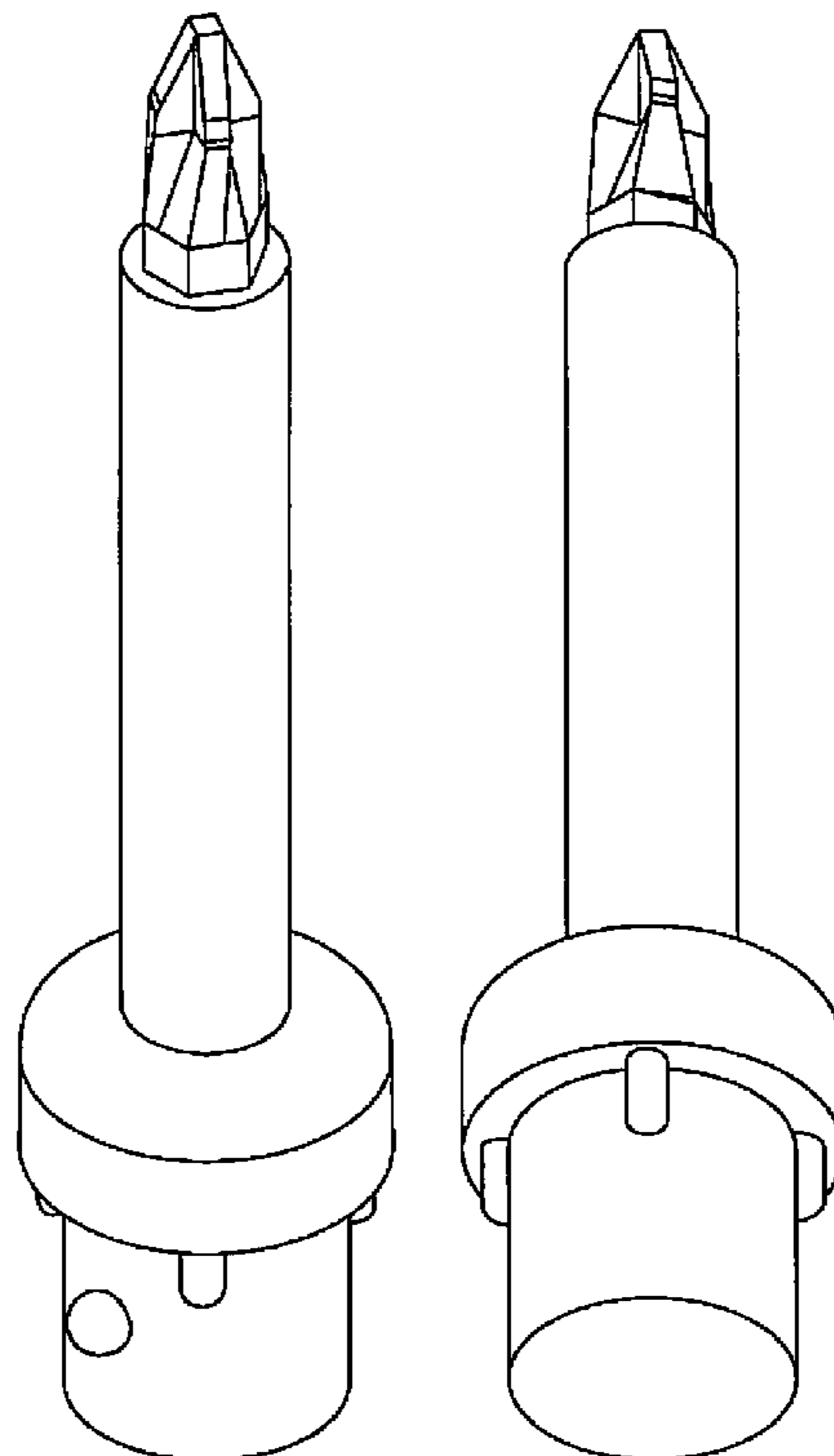

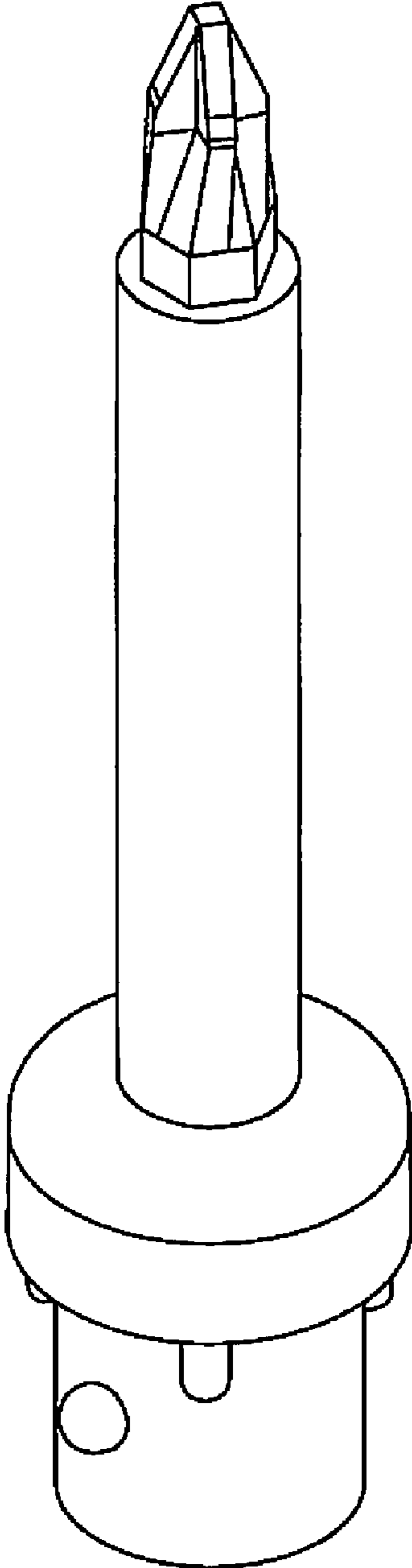

FIG. 1

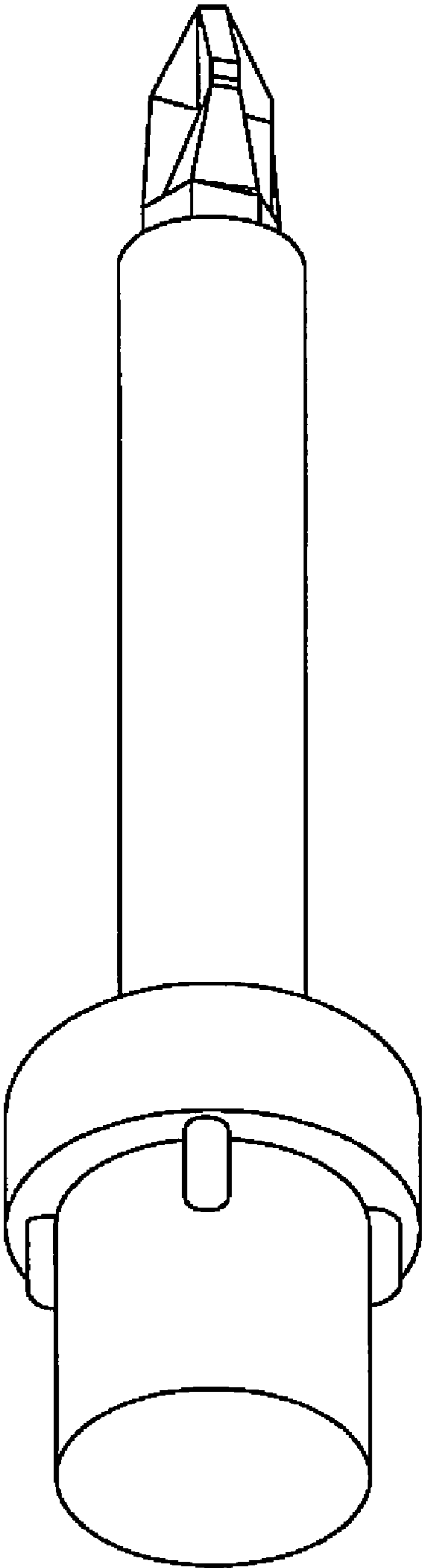

FIG. 2

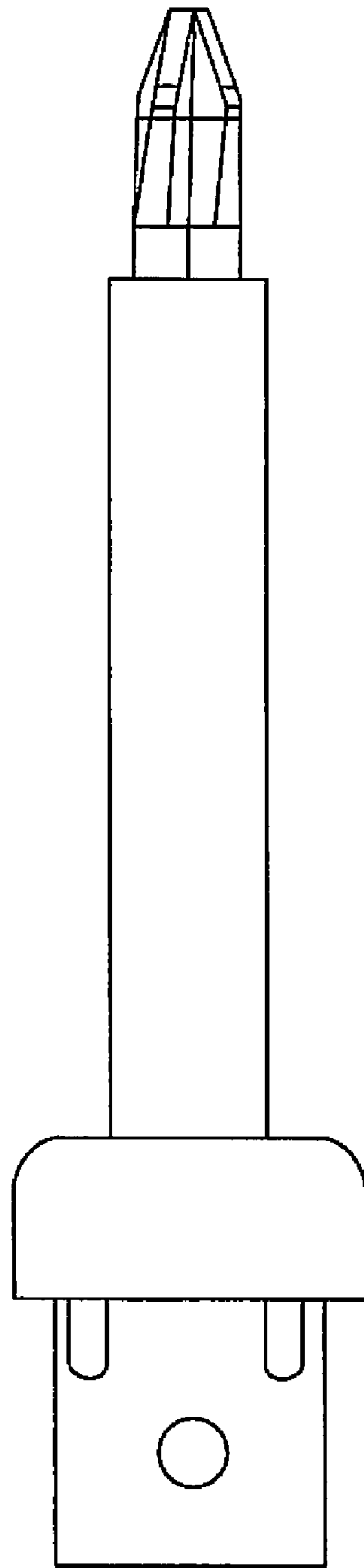

FIG. 3

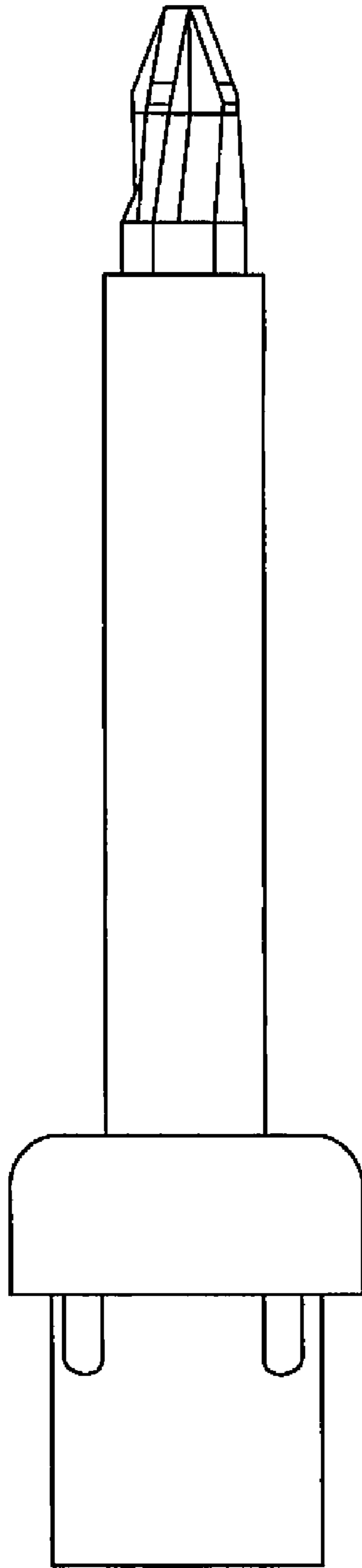

FIG. 4

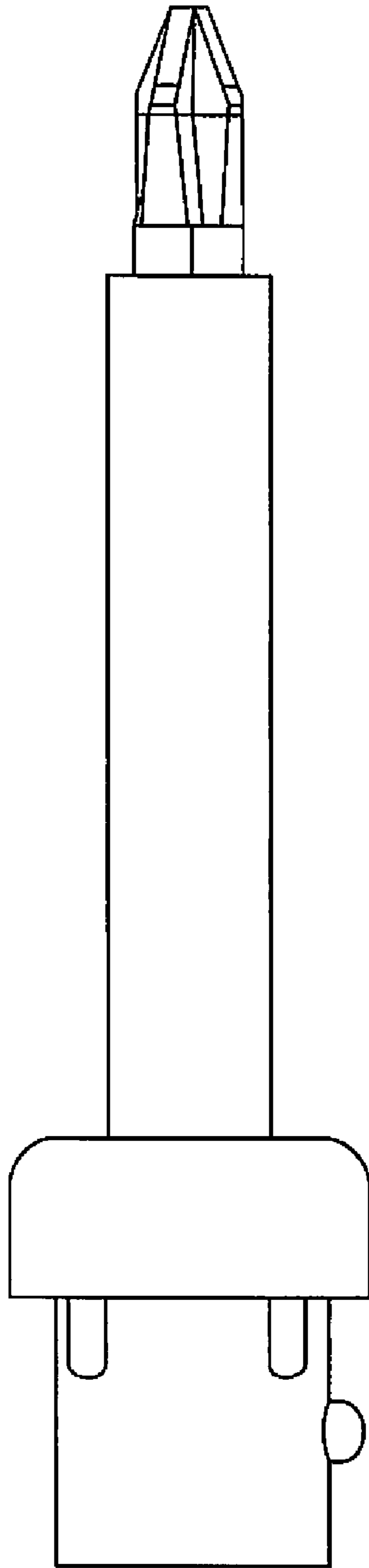

FIG. 5

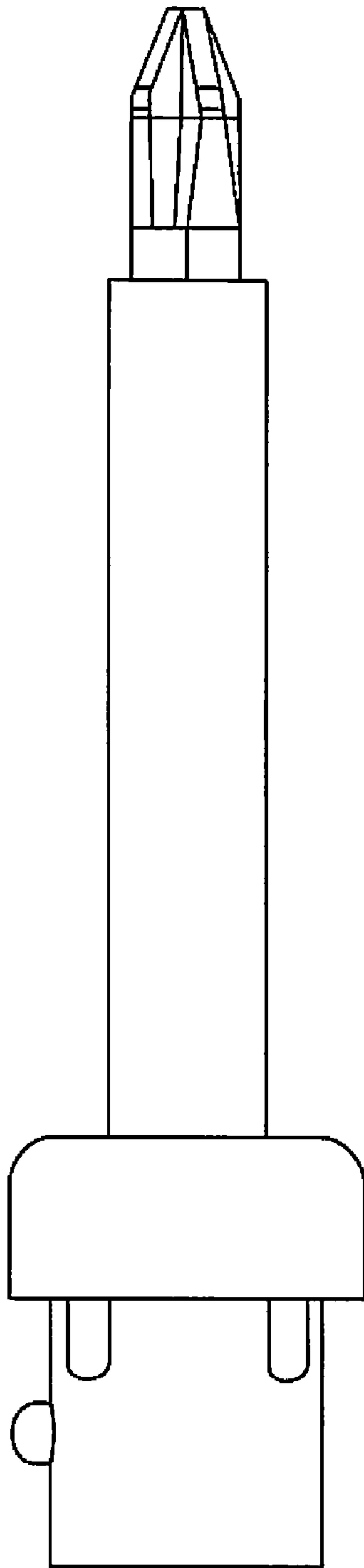

FIG. 6

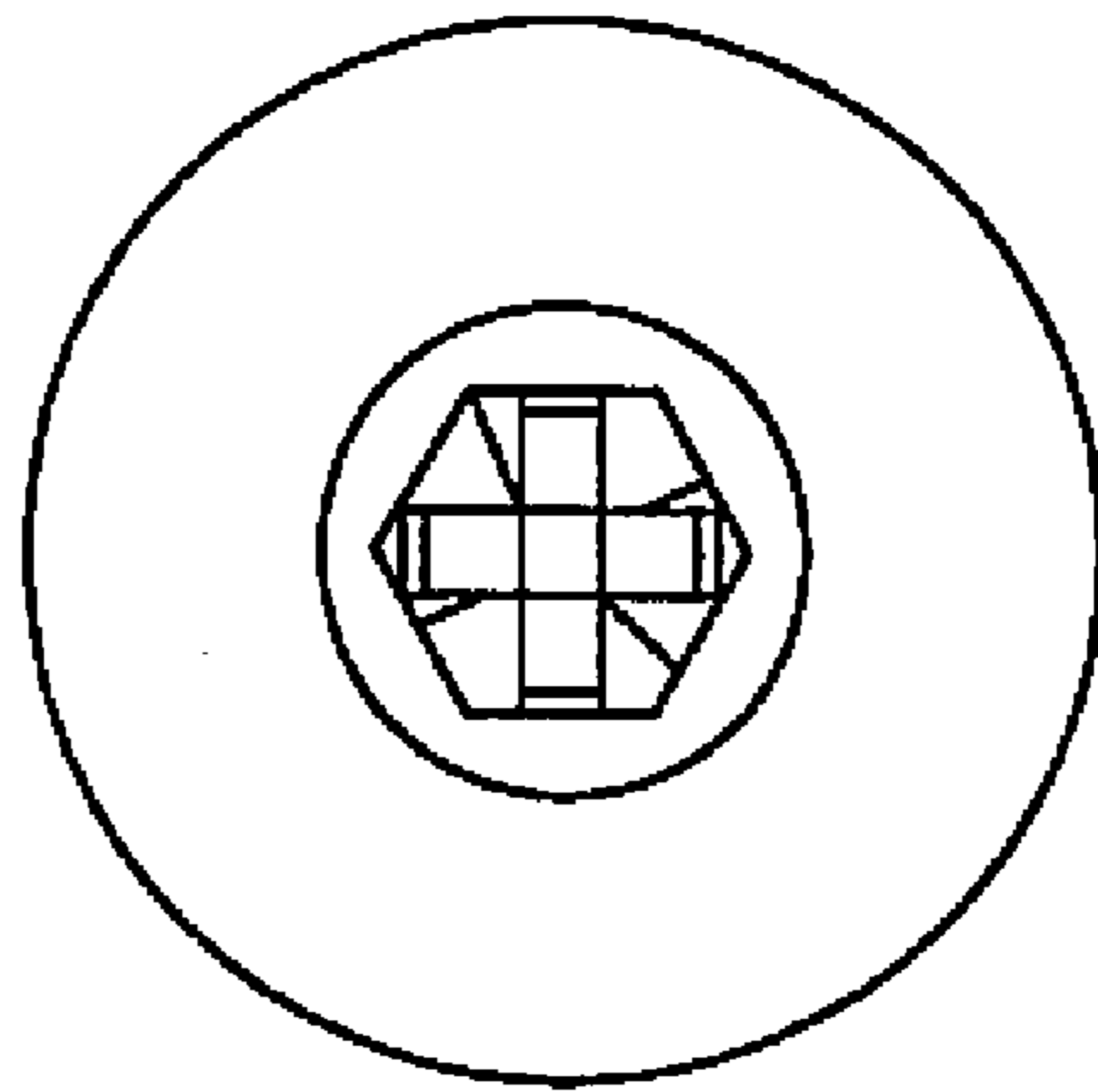

FIG. 7

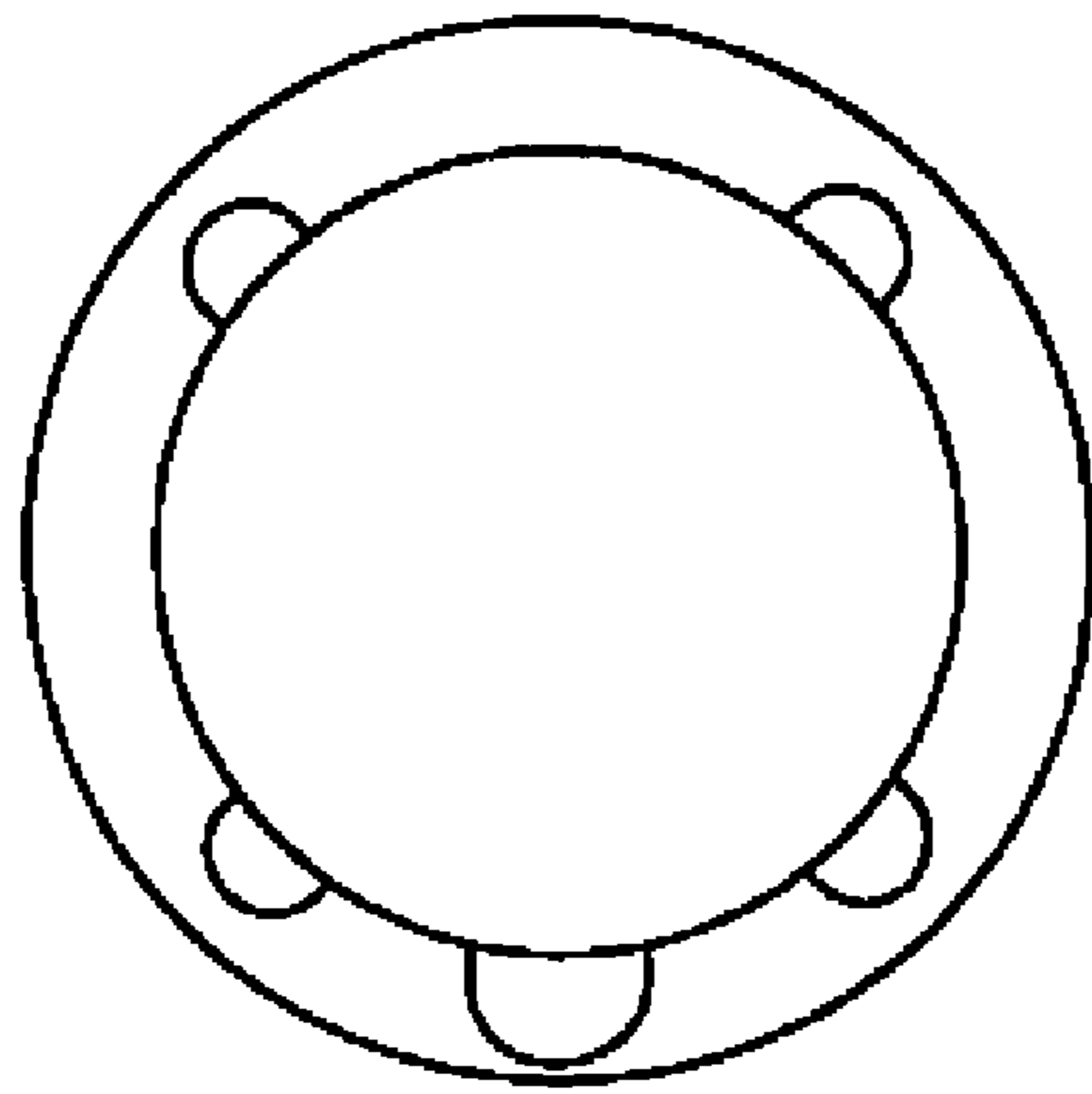

FIG. 8