



US00D606807S

(12) **United States Design Patent**  
**Humphreys et al.**

(10) **Patent No.:** **US D606,807 S**

(45) **Date of Patent:** **\*\* Dec. 29, 2009**

(54) **SET OF ELEMENTS IN THE SHAPE OF A SOCCER BALL**

*Primary Examiner*—Marianne Pandozzi  
(74) *Attorney, Agent, or Firm*—Nixon Peabody, LLP; Jeffrey L. Costellia

(75) Inventors: **Peter Humphreys**, Malmesbury (ZA);  
**Cornelius Frederik Van Der Nest**,  
Worcester (ZA)

(57) **CLAIM**

The ornamental design for a set of elements in the shape of a soccer ball, as shown and described.

(73) Assignee: **Scarlet IBIS Investments 53 (PTY) Ltd.**, Hatfield, Pretoria (ZA)

**DESCRIPTION**

(\*\*) Term: **14 Years**

(21) Appl. No.: **29/274,352**

(22) Filed: **Apr. 18, 2007**

(51) **LOC (9) Cl.** ..... **07-01**

(52) **U.S. Cl.** ..... **D7/505; D7/507; D7/515;**  
**D7/523; D7/901**

(58) **Field of Classification Search** ..... D7/590,  
D7/592, 596, 597, 599, 600.2, 505, 507, 510,  
D7/511, 523, 515, 901, 606, 301–303, 598,  
D7/619.2; D9/538, 546, 556, 431, 430, 668,  
D9/549, 651; 273/153 R; 224/148.4; 428/10;  
446/121; 220/703; D21/713, 714

See application file for complete search history.

FIG. 1 is a perspective view of a set of elements in the shape of a soccer ball showing our new design;

FIG. 2 is a perspective view of the central mounting core of the set of elements in the shape of a soccer ball with the rest of the elements removed for ease of illustration;

FIG. 3 is a partial exploded perspective view of the set of elements in the shape of a soccer ball;

FIG. 4 is a bottom perspective view of a pentagonal element of the set of elements in the shape of a soccer ball with the rest of the parts of the set of elements in the shape of a soccer ball removed for ease of illustration;

FIG. 5 is a top perspective view thereof;

FIG. 6 is a side elevational view thereof;

FIG. 7 is a bottom plan view thereof;

FIG. 8 is a top plan view thereof;

FIG. 9 is a bottom perspective view of a hexagonal element of the set of elements in the shape of a soccer ball with the rest of the parts of the set of elements in the shape of a soccer ball removed for ease of illustration;

FIG. 10 is a top perspective view thereof;

FIG. 11 is a side elevational view thereof;

FIG. 12 is a bottom plan view thereof; and,

FIG. 13 is a top plan view thereof.

The pentagonal elements and hexagonal elements may be used to hold liquid beverage or granular food items therein.

The broken lines shown in the figures are for illustrative purposes only, and form no part of the claimed design.

(56) **References Cited**

**U.S. PATENT DOCUMENTS**

D43,781 S *	4/1913	Sanford	.....	D7/597
4,339,062 A *	7/1982	Witt, Jr.	.....	224/148.4
4,493,862 A *	1/1985	Allbert et al.		
D277,455 S *	2/1985	Tordjman	.....	D9/546
4,606,544 A *	8/1986	Olazabal, Jr.	.....	473/605
D304,298 S *	10/1989	Bannister	.....	D9/546
D307,709 S *	5/1990	Liss	.....	D9/694
5,340,349 A *	8/1994	Berg-Fernstrum	.....	446/126
D375,047 S *	10/1996	Jivago	.....	D9/651
D379,136 S *	5/1997	Salvato	.....	D7/596
D391,451 S *	3/1998	Todorya	.....	D7/606
D399,426 S *	10/1998	Jivago	.....	D9/651
5,826,872 A *	10/1998	Hall	.....	273/156
5,853,823 A *	12/1998	McKenna		
D418,514 S *	1/2000	Adelaar	.....	D14/232
D419,387 S *	1/2000	Hansen	.....	D7/606

(Continued)

**1 Claim, 9 Drawing Sheets**

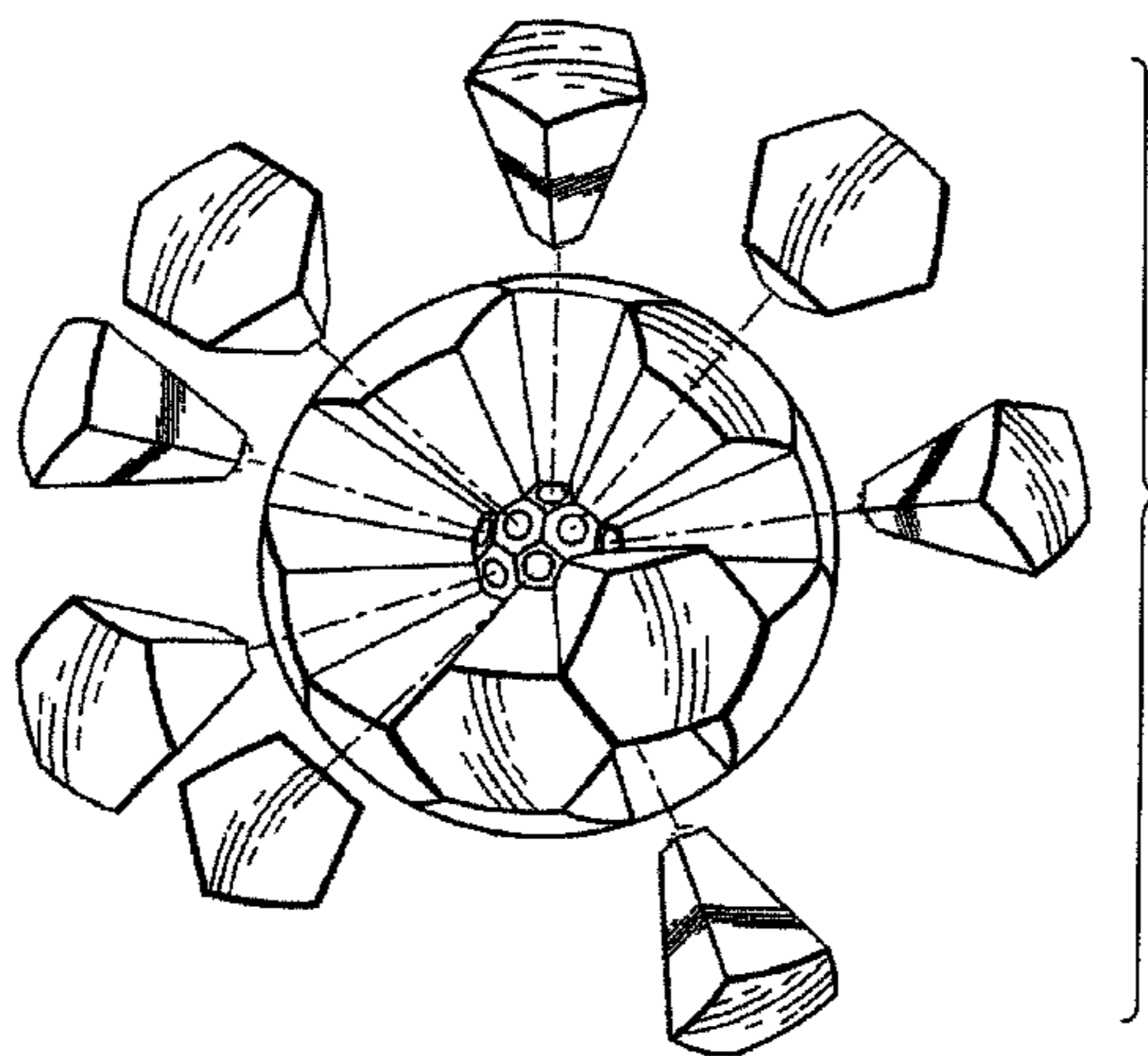

# US D606,807 S

Page 2

---

## U.S. PATENT DOCUMENTS

D434,325 S	*	11/2000	Jivago .....	D9/651	D563,171 S	*	3/2008	Mansfield .....	D7/523
D519,845 S	*	5/2006	Ortiz .....	D9/651	D594,703 S	*	6/2009	Sax et al. ....	D7/515
D529,377 S	*	10/2006	Heiss .....	D9/431	D598,322 S	*	8/2009	Kunz .....	D11/147
D558,285 S	*	12/2007	Avis et al. ....	D21/713	2007/0000452	A1*	1/2007	Barney	

\* cited by examiner

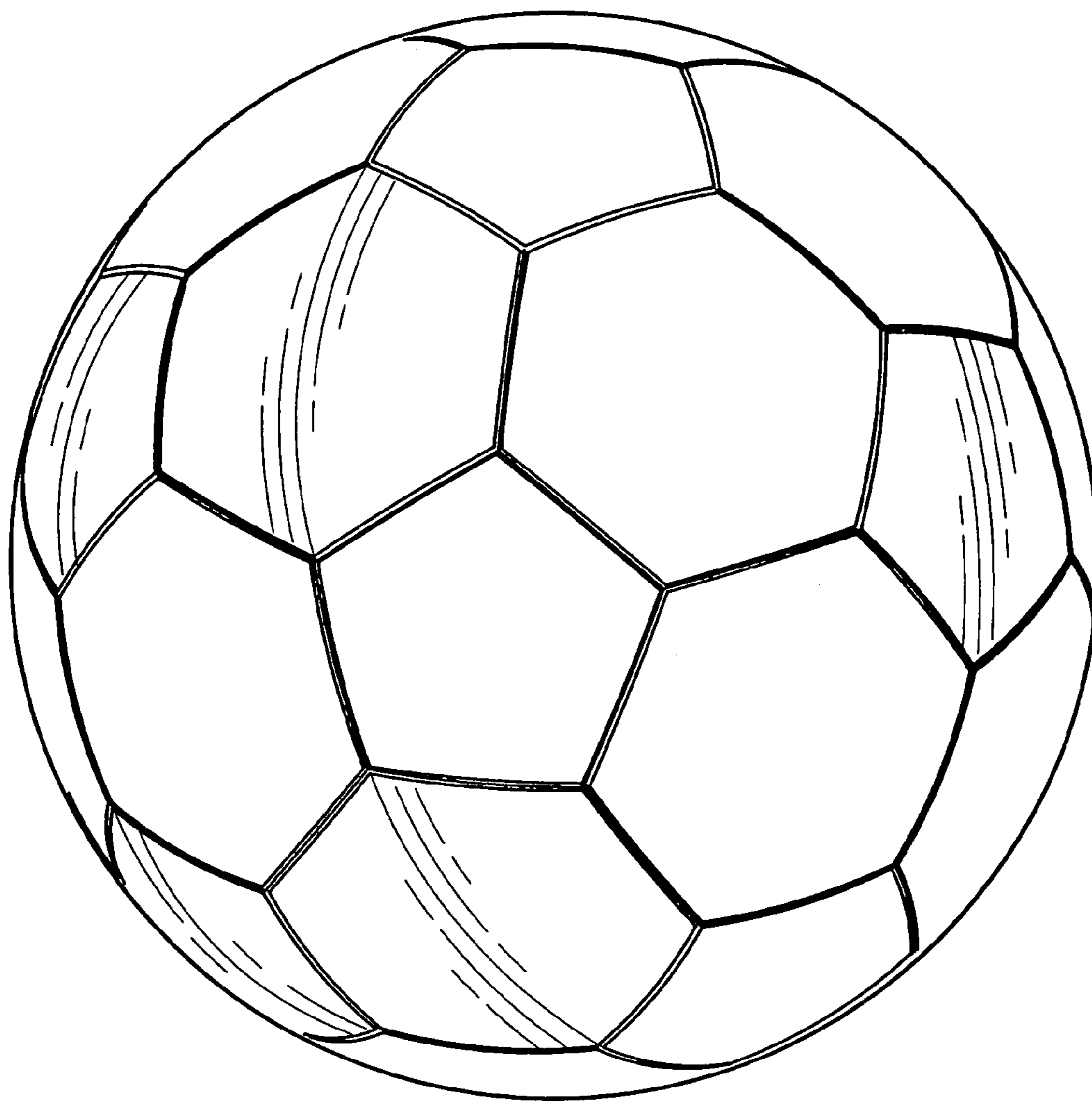
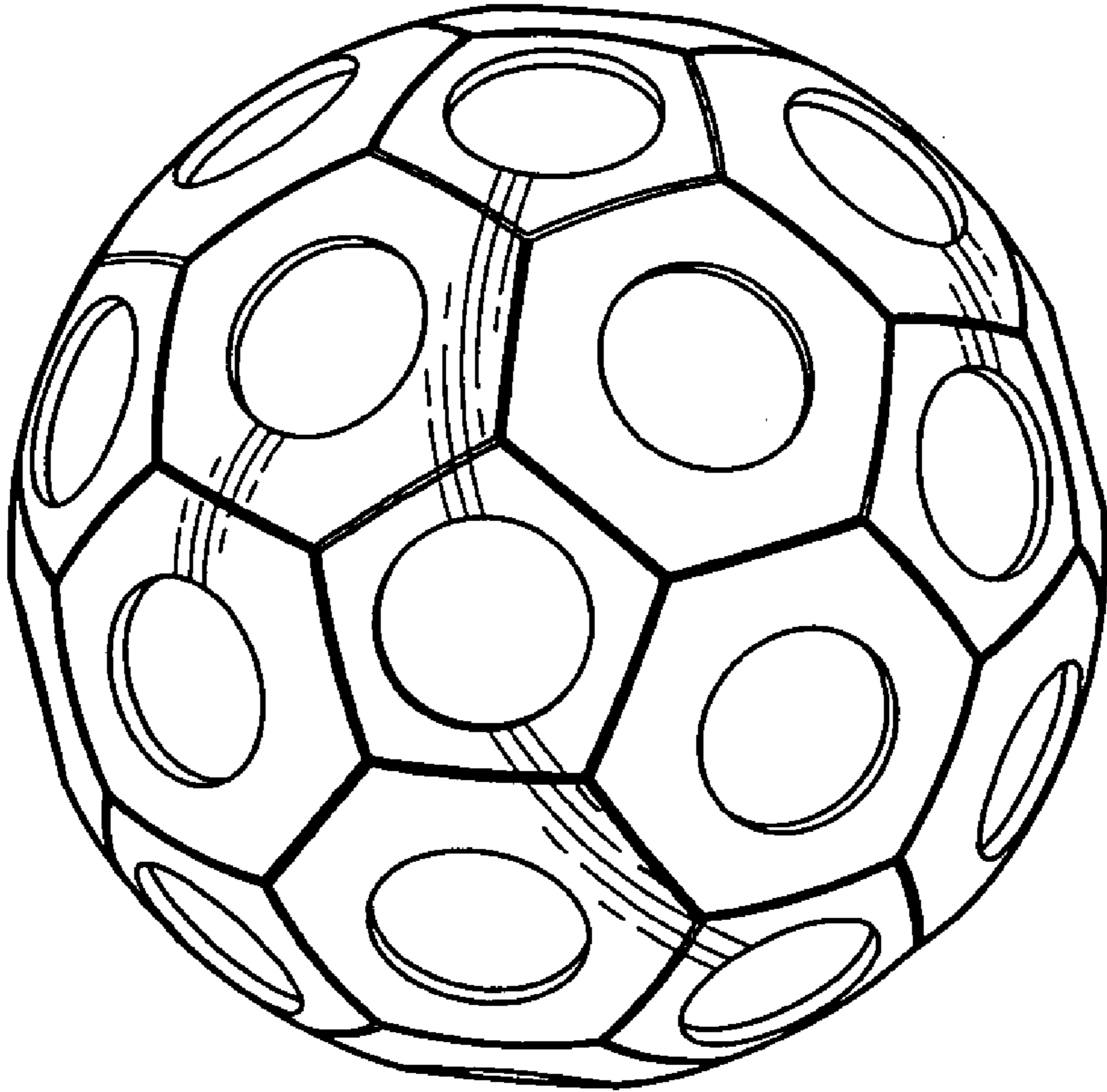
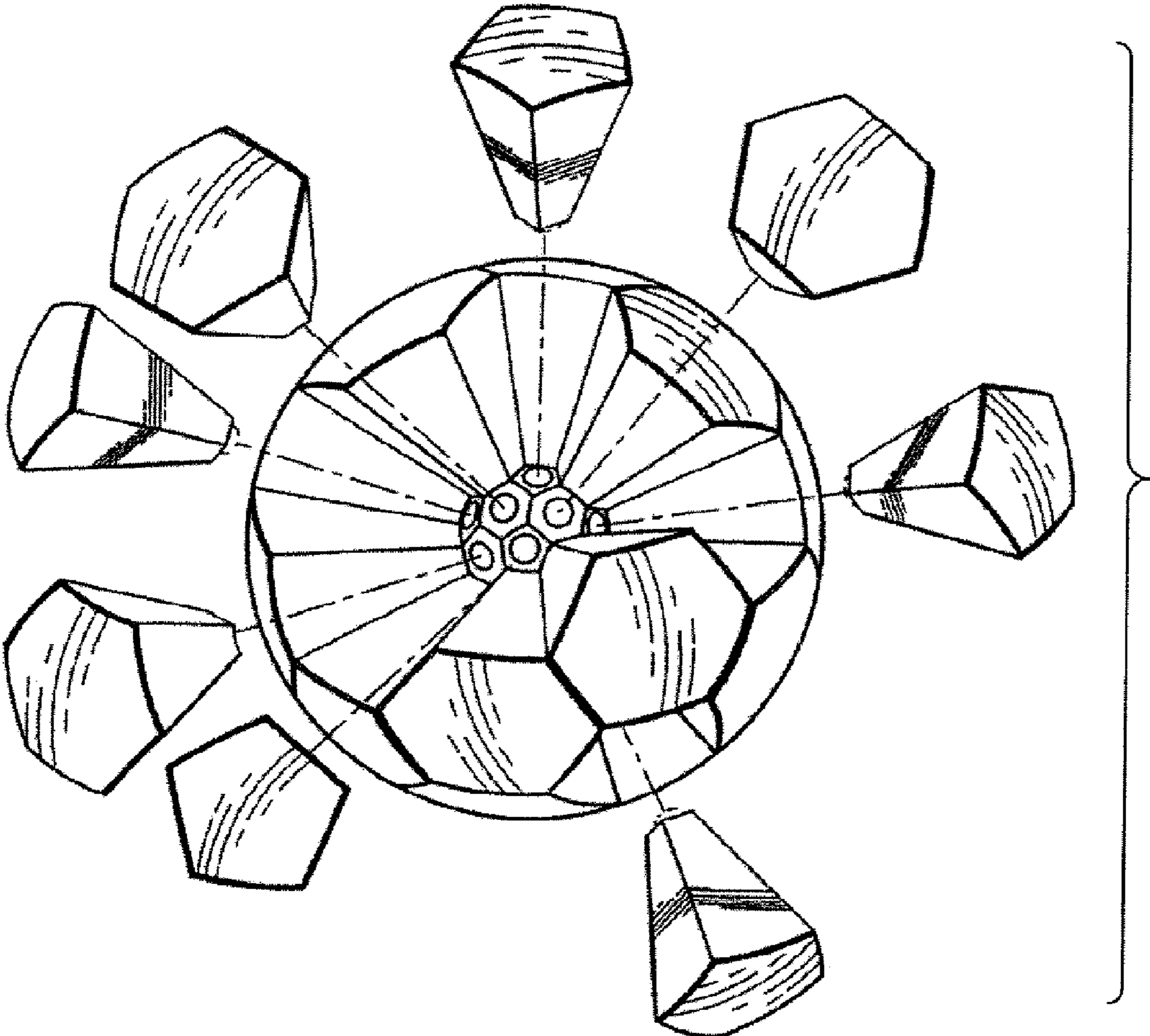

FIG 1



**FIG 2**

FIG. 3



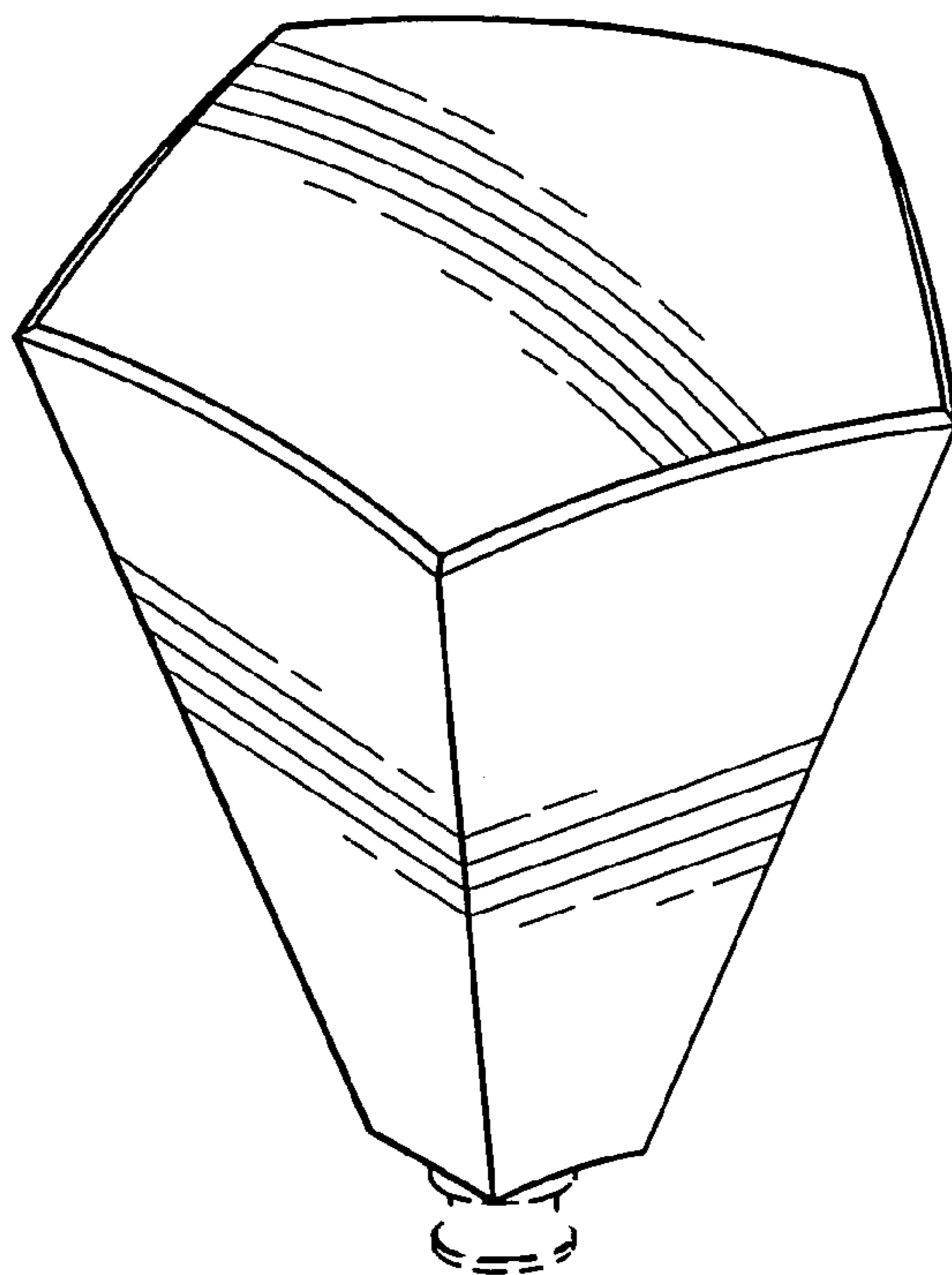

FIG 4

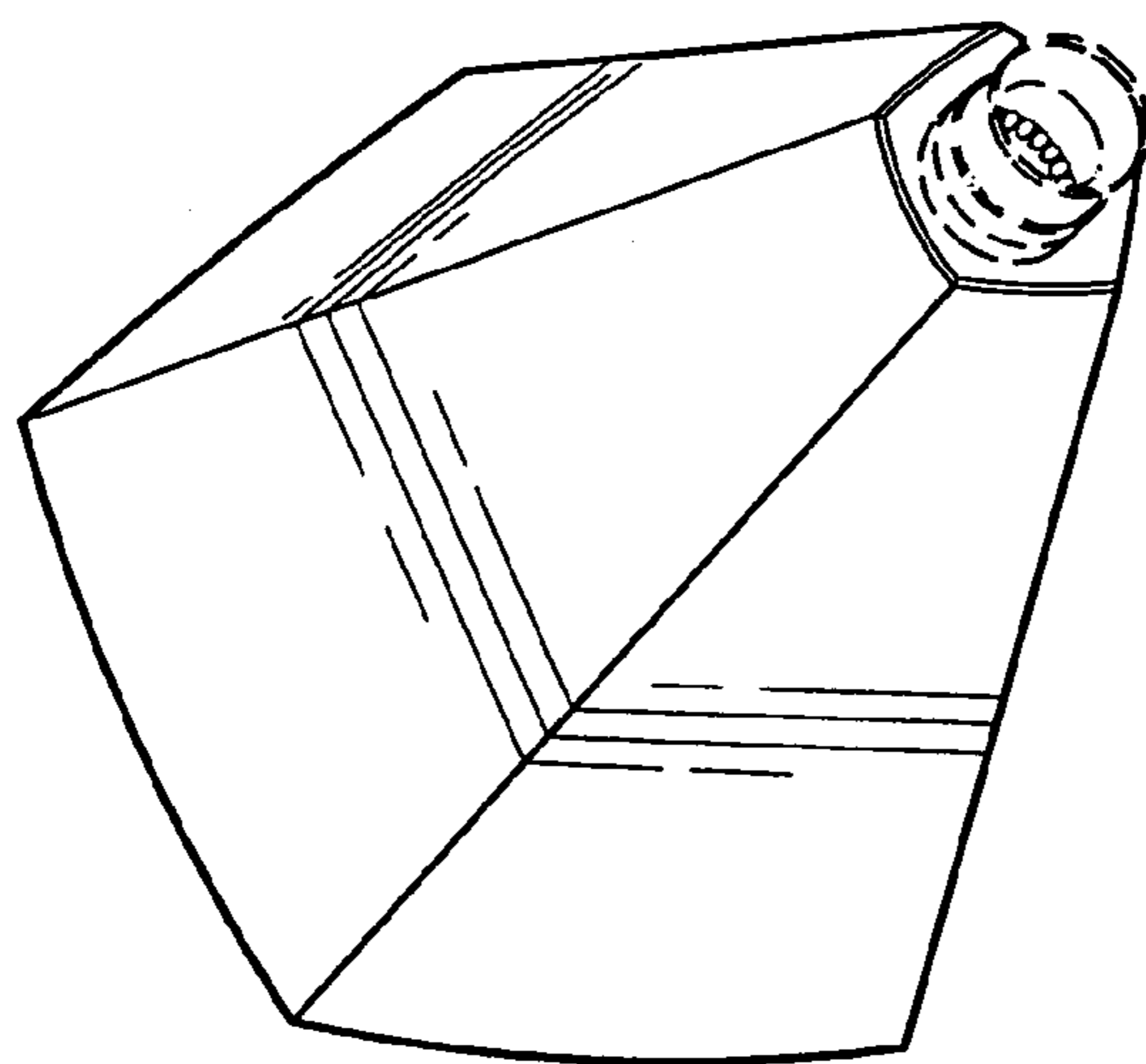
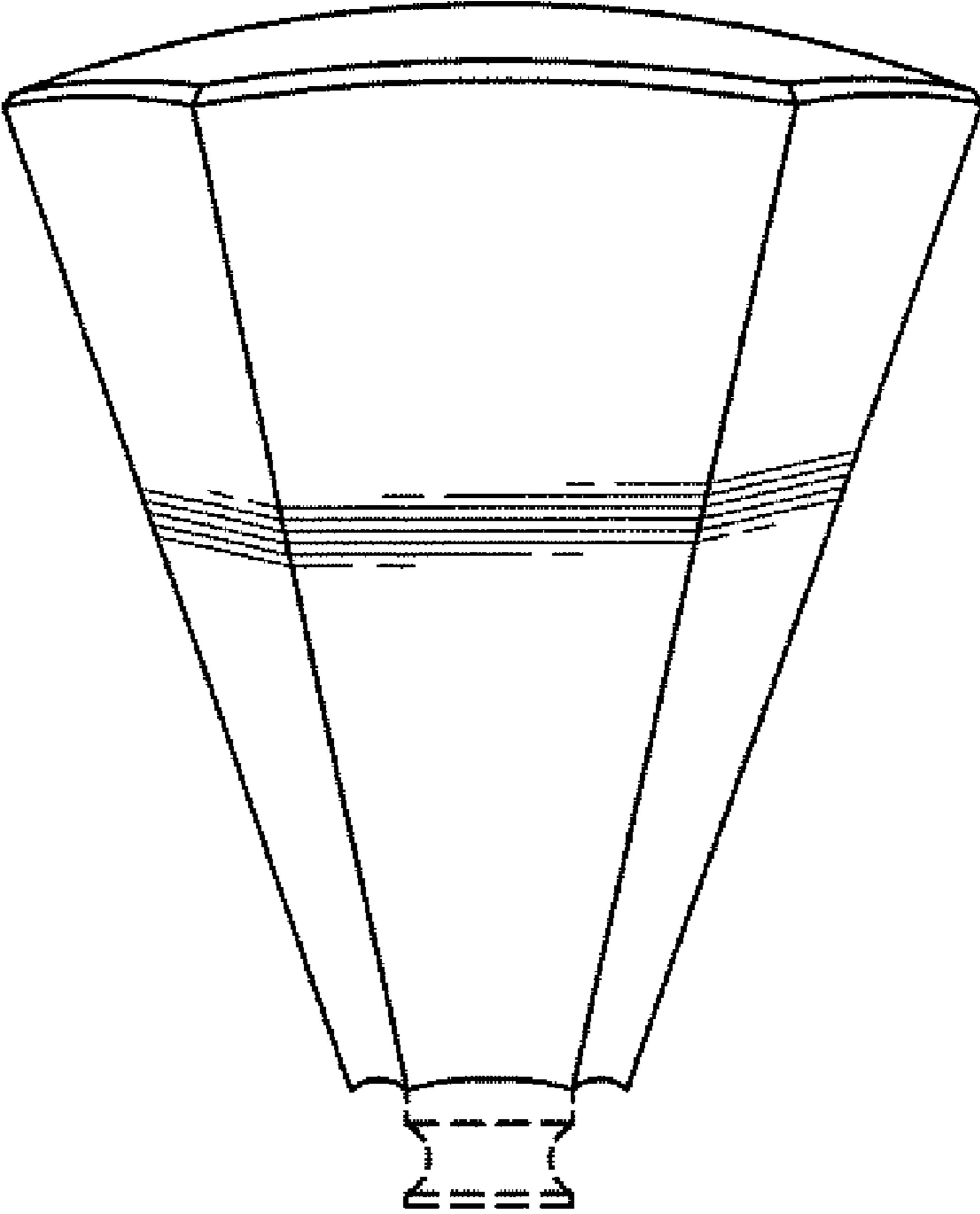
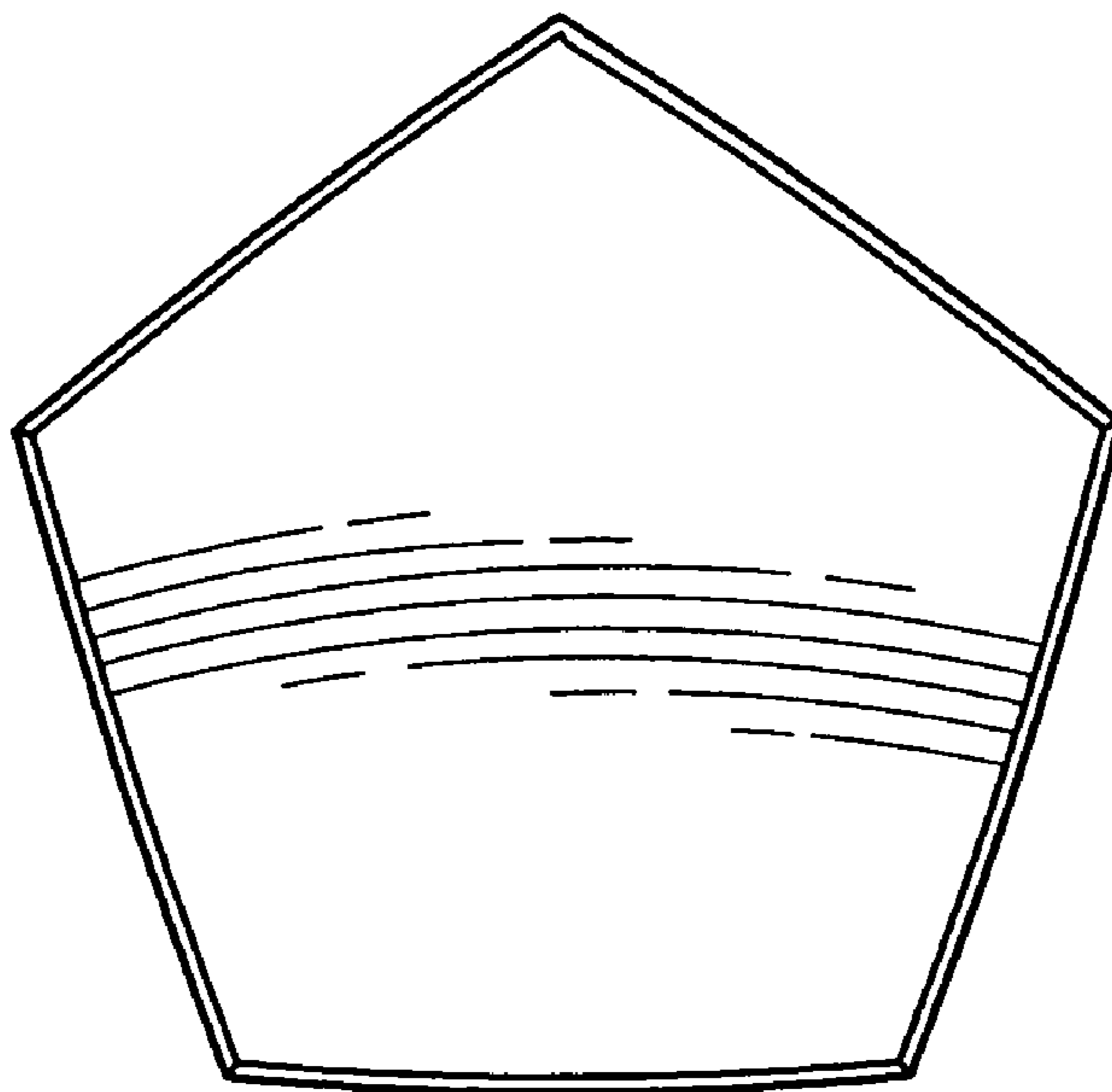

FIG 5

FIG. 6





**FIG 7**

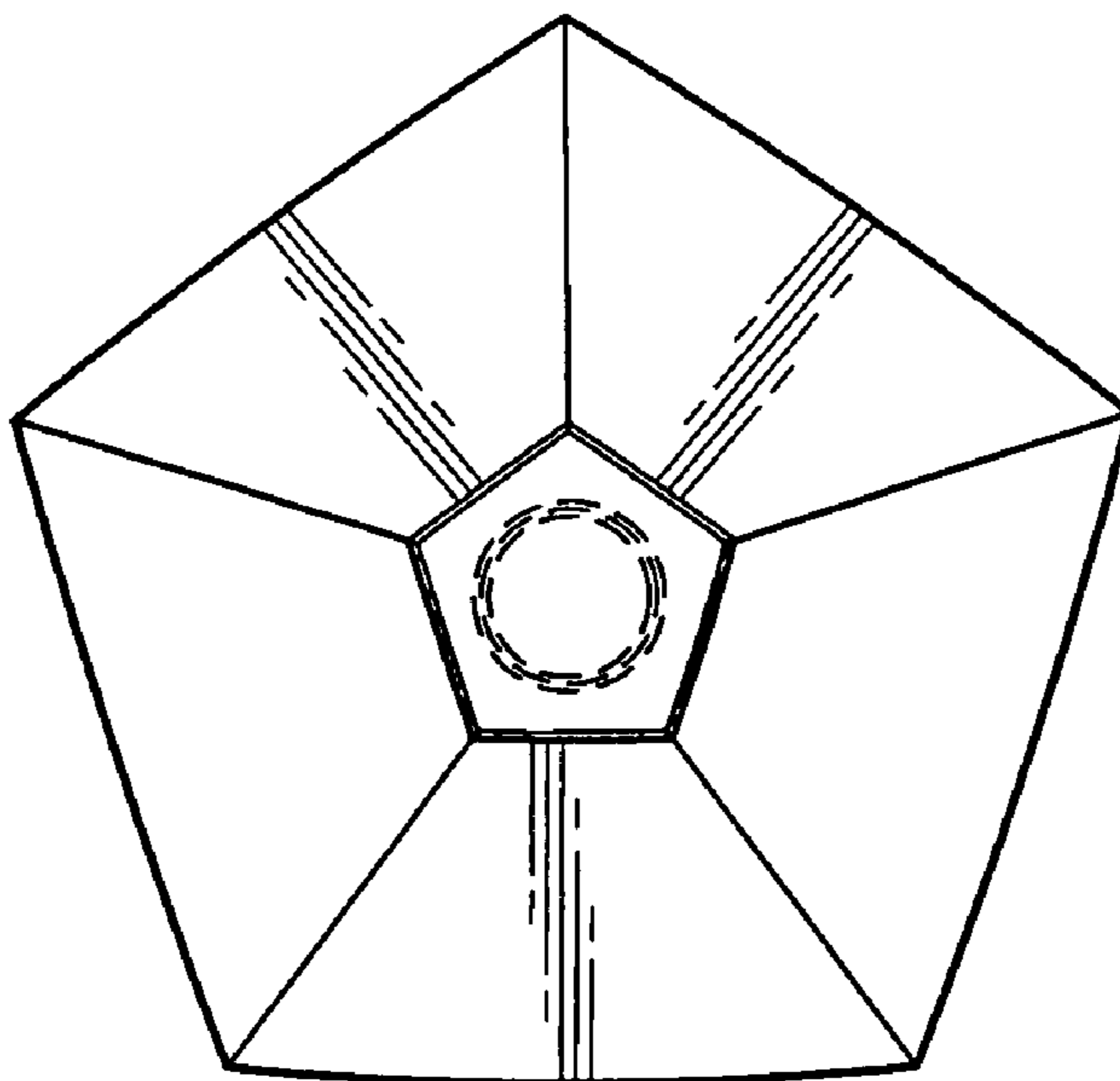

**FIG 8**



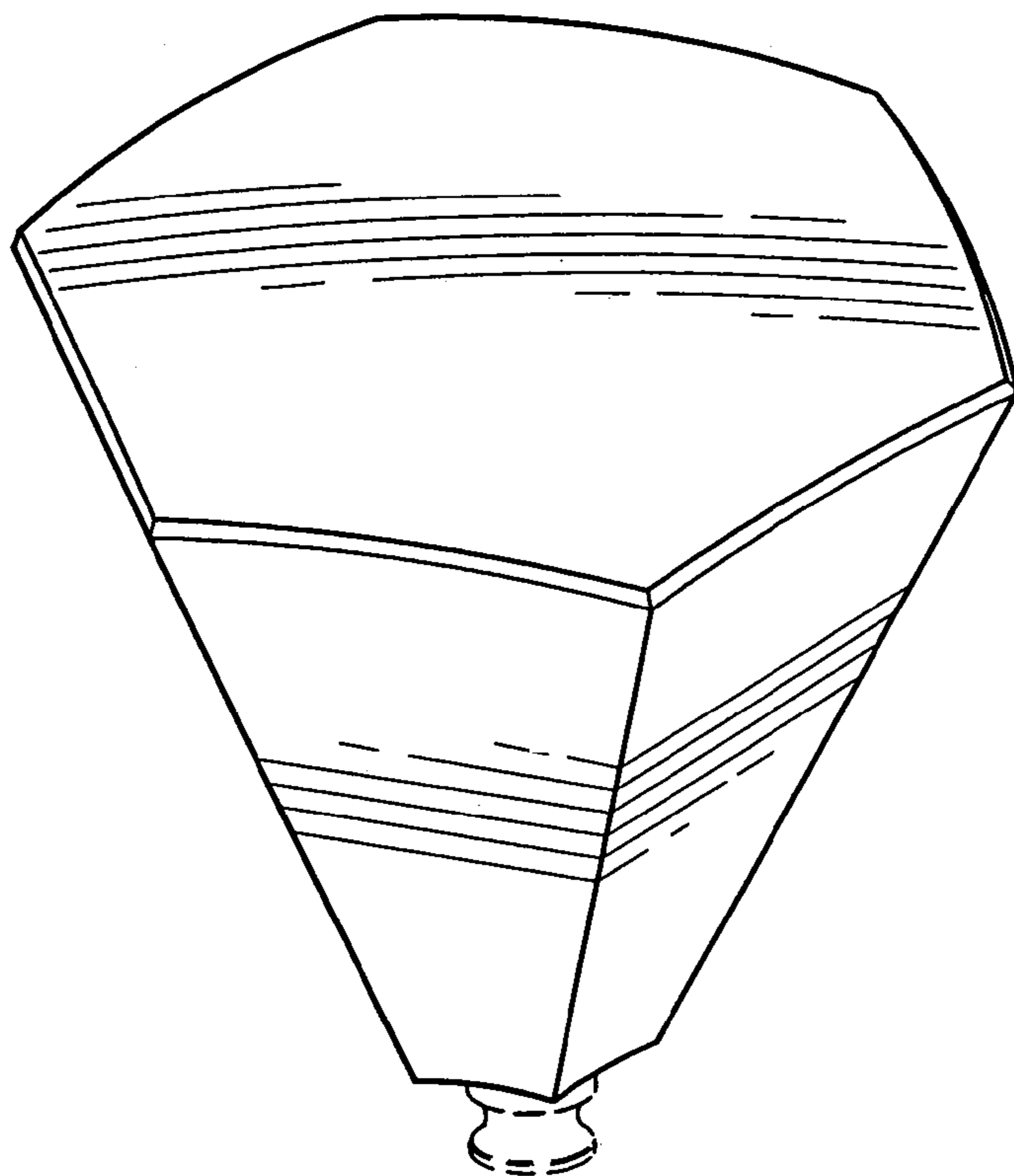

FIG 9

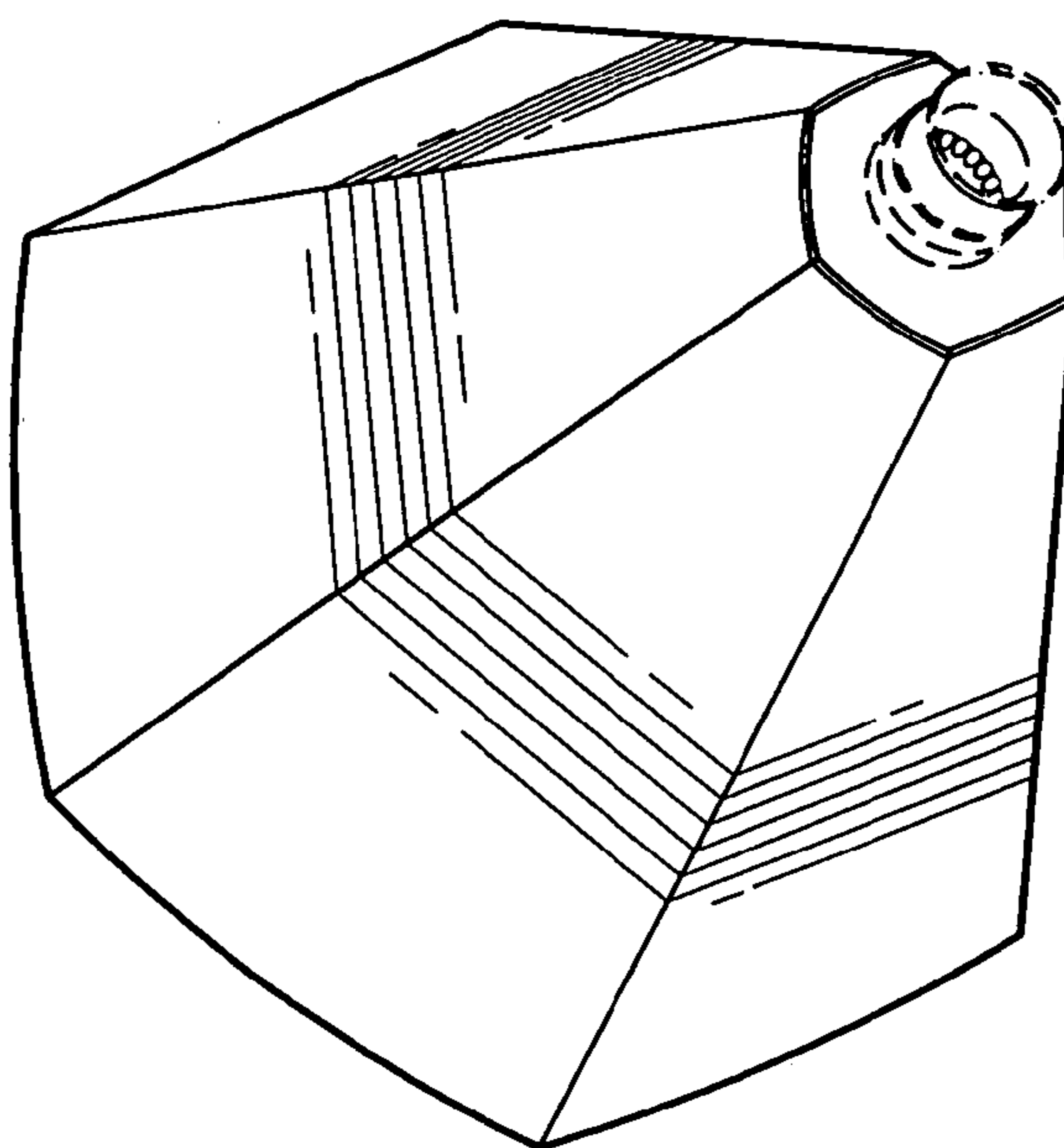
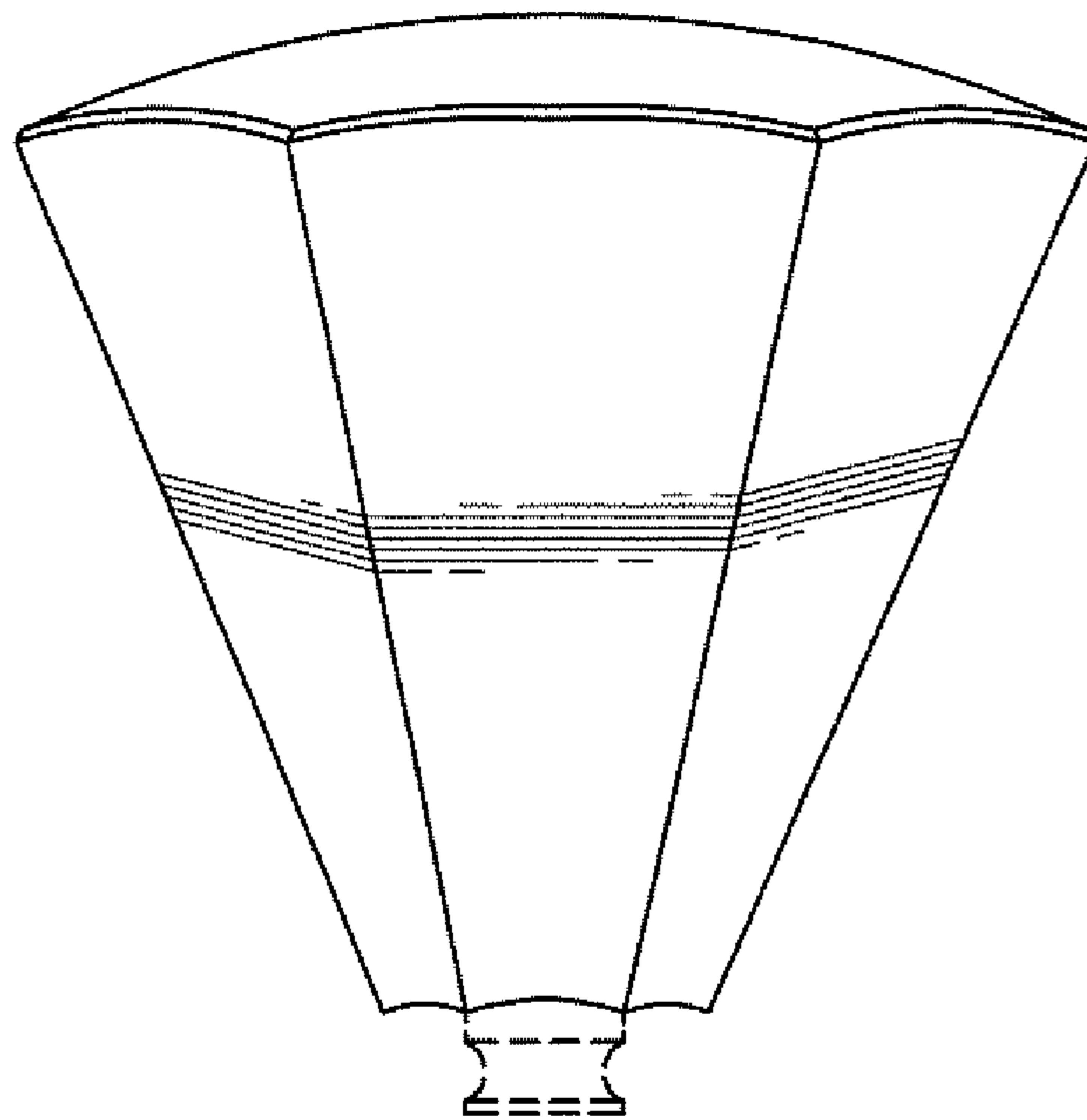

FIG 10

FIG. 11



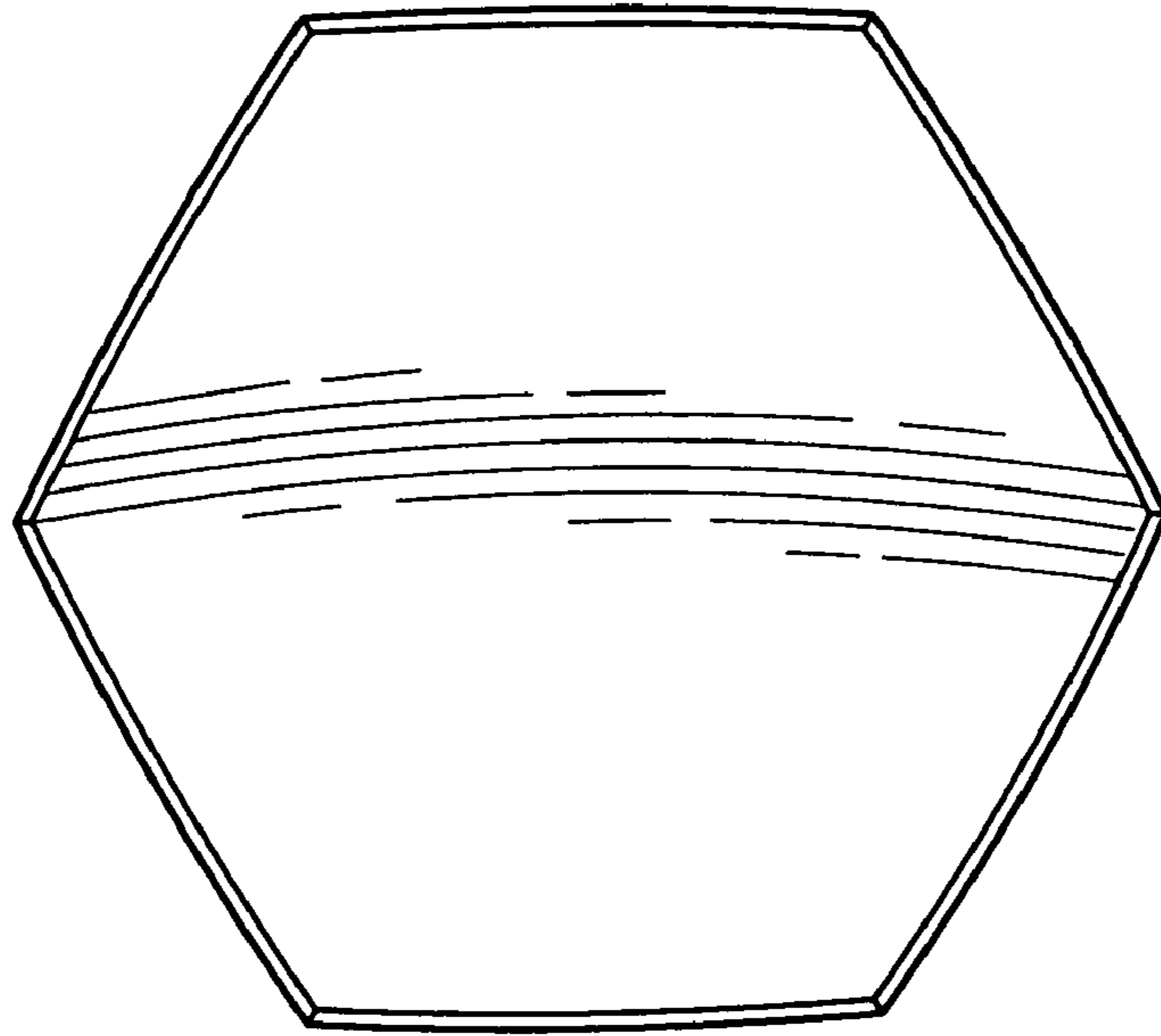

FIG 12

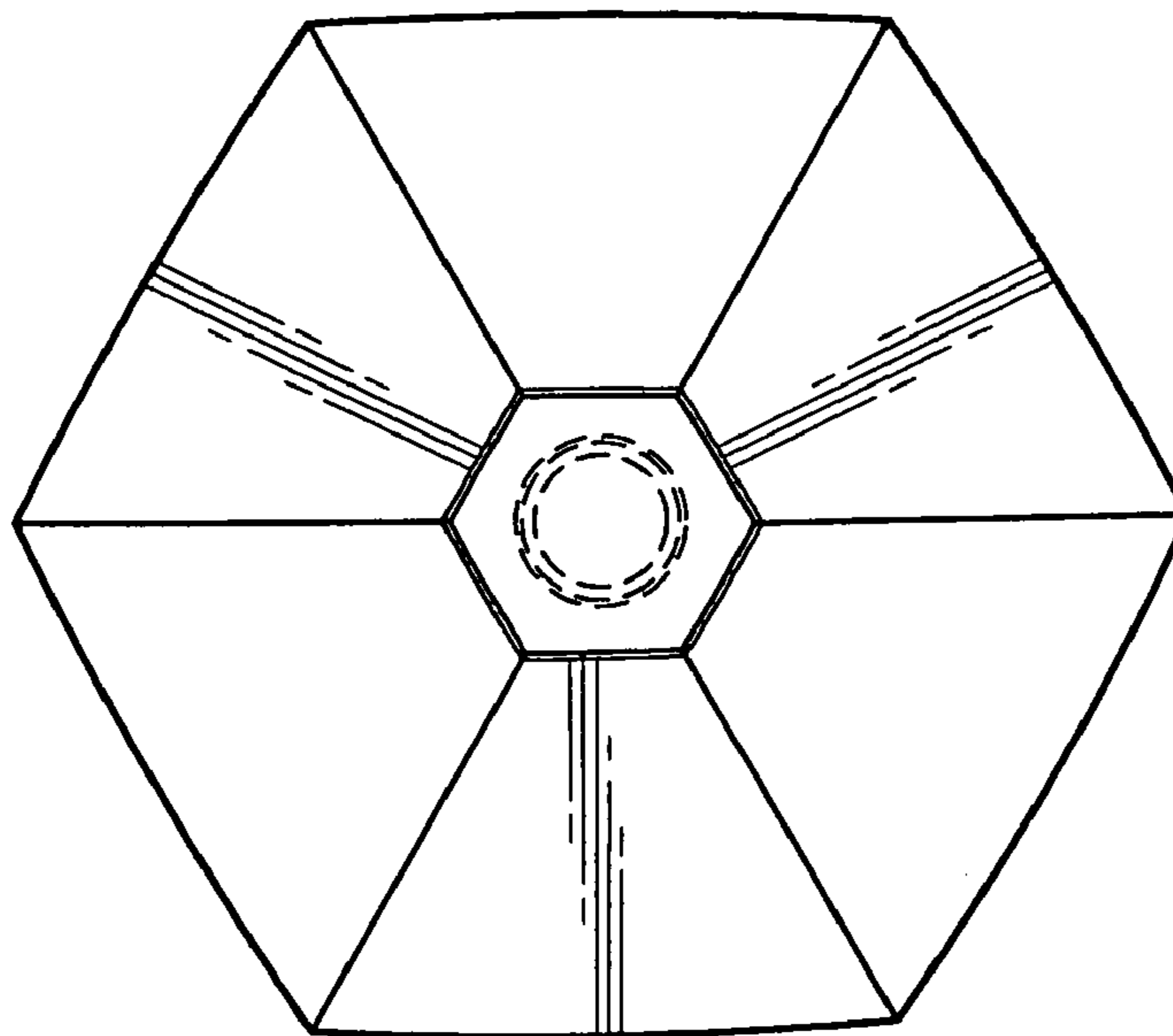

FIG 13