



US00D606752S

(12) **United States Design Patent**
Evans

(10) **Patent No.:** **US D606,752 S**

(45) **Date of Patent:** **** Dec. 29, 2009**

(54) **CLAIM STAKE CAPSULE WITH SEALABLE AND REMOVABLE TOP AND SUPPORT EXTENSION**

(76) Inventor: **Donald L. Evans**, 9698 Shadowstone Way, Reno, NV (US) 89521

(**) Term: **14 Years**

(21) Appl. No.: **29/310,987**

(22) Filed: **Sep. 23, 2008**

(51) **LOC (9) Cl.** **03-01**

(52) **U.S. Cl.** **D3/302; D99/99**

(58) **Field of Classification Search** D3/201, D3/271.1, 272-273, 294-295, 298, 302; D7/612; D9/428, 780; D99/99; 206/315.1, 206/579

See application file for complete search history.

(56) **References Cited**

U.S. PATENT DOCUMENTS

D23,449 S *	7/1894	Bourne	D3/294
D263,269 S *	3/1982	Strathman	D7/667
D276,285 S *	11/1984	Tober et al.	D3/300
D276,571 S *	12/1984	Fairchild	D3/229
D330,818 S *	11/1992	Brandt	D6/472
D338,317 S *	8/1993	Woodward	D99/28
5,312,008 A *	5/1994	Davis	220/4.21
5,641,064 A *	6/1997	Goserud	206/315.1
D424,431 S *	5/2000	Suzuki	D3/301
D434,980 S *	12/2000	Suzuki	D9/418
D446,116 S *	8/2001	Nytko	D9/428
D448,290 S *	9/2001	Schultz et al.	D9/428
D453,323 S *	2/2002	Conrad	D13/154
D466,814 S *	12/2002	Hurlburt	D9/504
D479,684 S *	9/2003	Miller	D9/428

D499,552 S *	12/2004	Nissanoff et al.	D3/302
D501,996 S *	2/2005	Schultz	D3/283
D507,495 S *	7/2005	Williams et al.	D9/719
D535,476 S *	1/2007	Pennington	D3/271.1
D543,647 S *	5/2007	Goldenberg	D26/22
D553,322 S *	10/2007	Naber	D34/9
D579,324 S *	10/2008	Schmidt	D9/418
D585,305 S *	1/2009	Alvares et al.	D9/780
D588,361 S *	3/2009	Dawson et al.	D3/302

* cited by examiner

Primary Examiner—Philip S Hyder

Assistant Examiner—Roselyne Cody

(74) *Attorney, Agent, or Firm*—George W. Wasson

(57) **CLAIM**

The ornamental design for a claim stake capsule with sealable and removable top and support extension, as shown and described.

DESCRIPTION

FIG. 1 is a side elevation view of the claim stake capsule with sealable and removable top and support extension with the top removed;

FIG. 2 is an opposite side elevation view thereof;

FIG. 3 is a front elevation view thereof;

FIG. 4 is a rear elevation view thereof;

FIG. 5 is a top plan view thereof showing the exterior of the top and the interior of the body;

FIG. 6 is a bottom view thereof showing the interior of the top and the bottom exterior of the body; and,

FIG. 7 is a perspective view thereof.

1 Claim, 7 Drawing Sheets

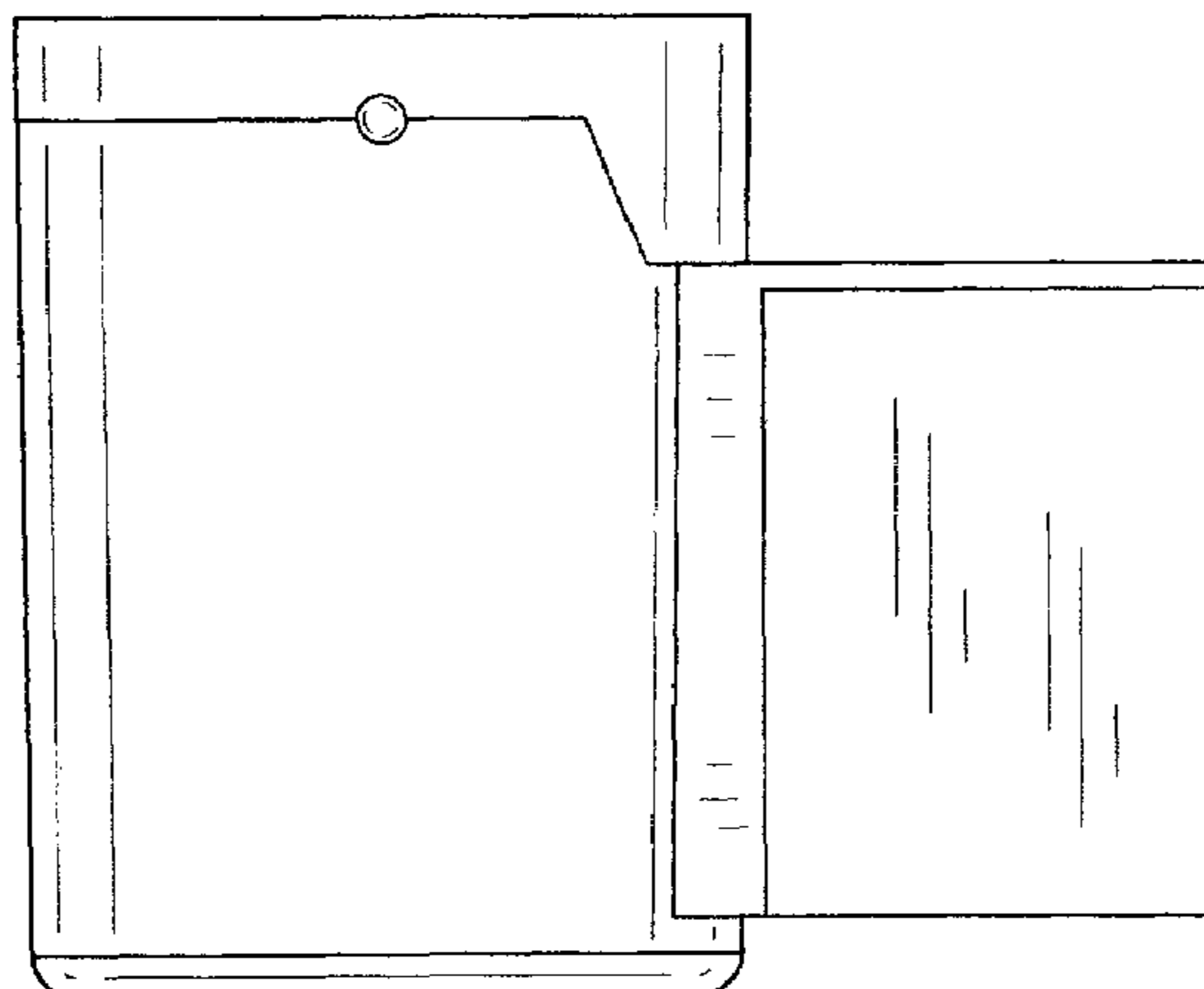
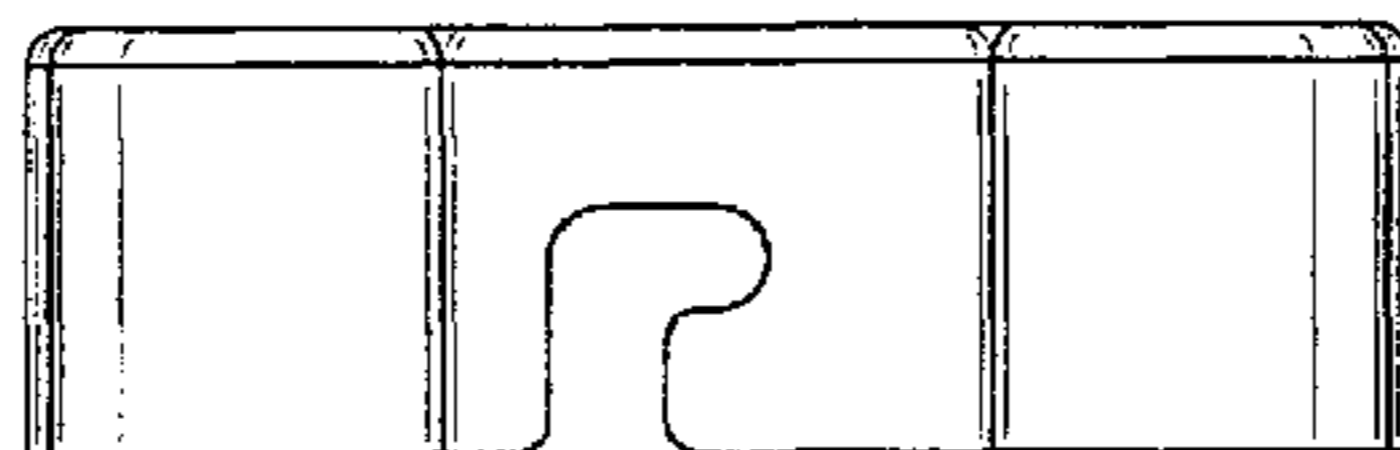

FIG. 1

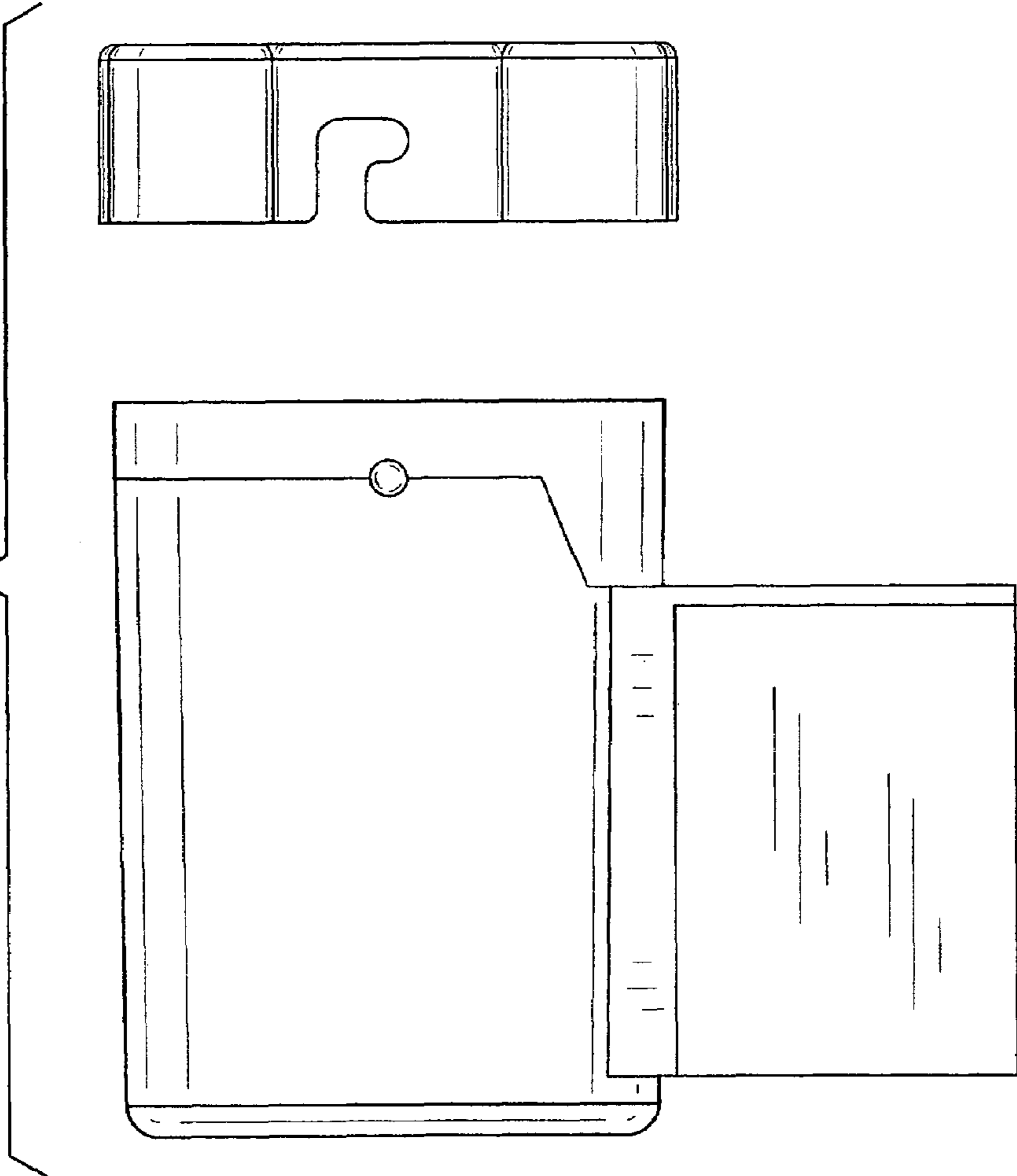
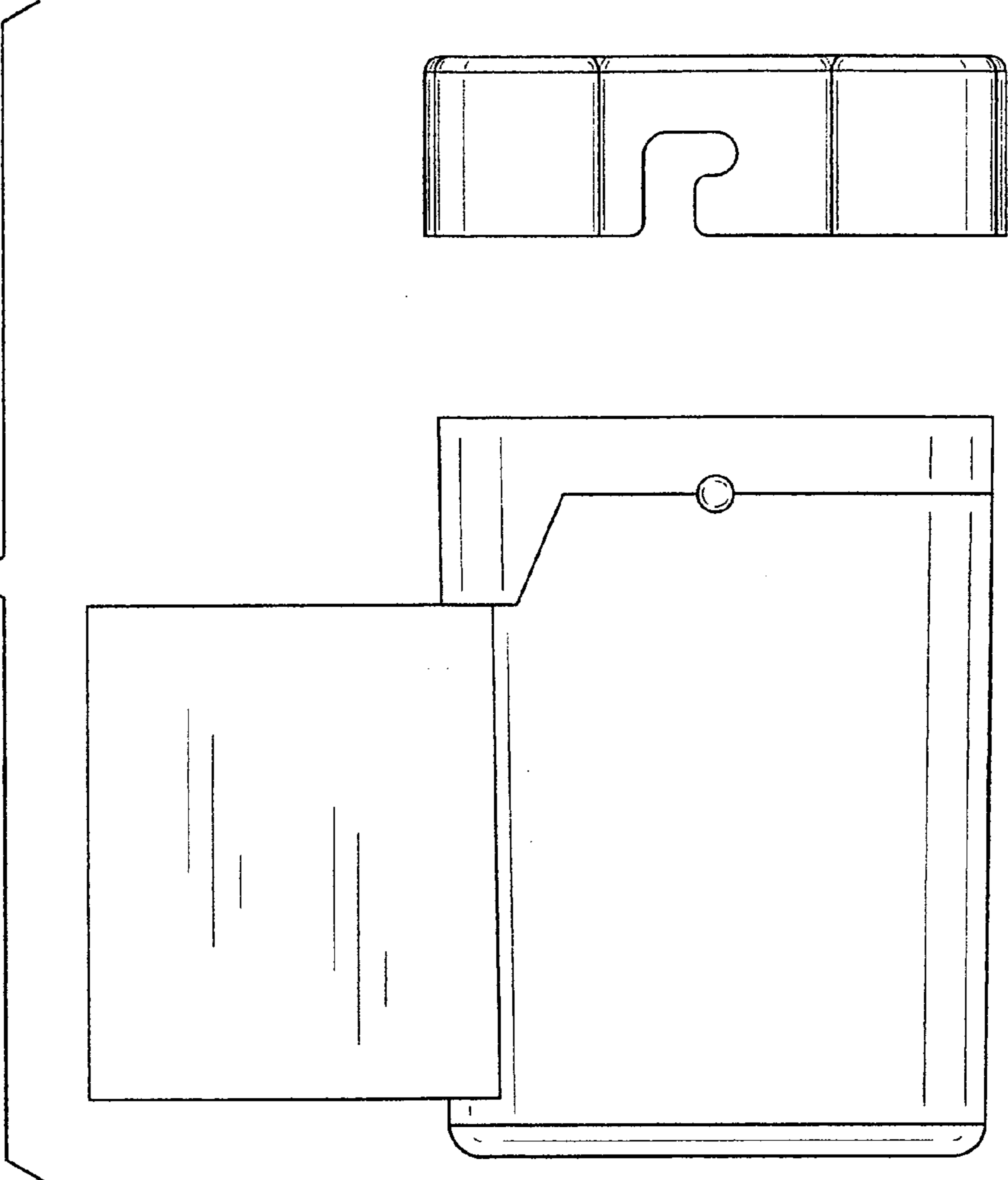

FIG. 2



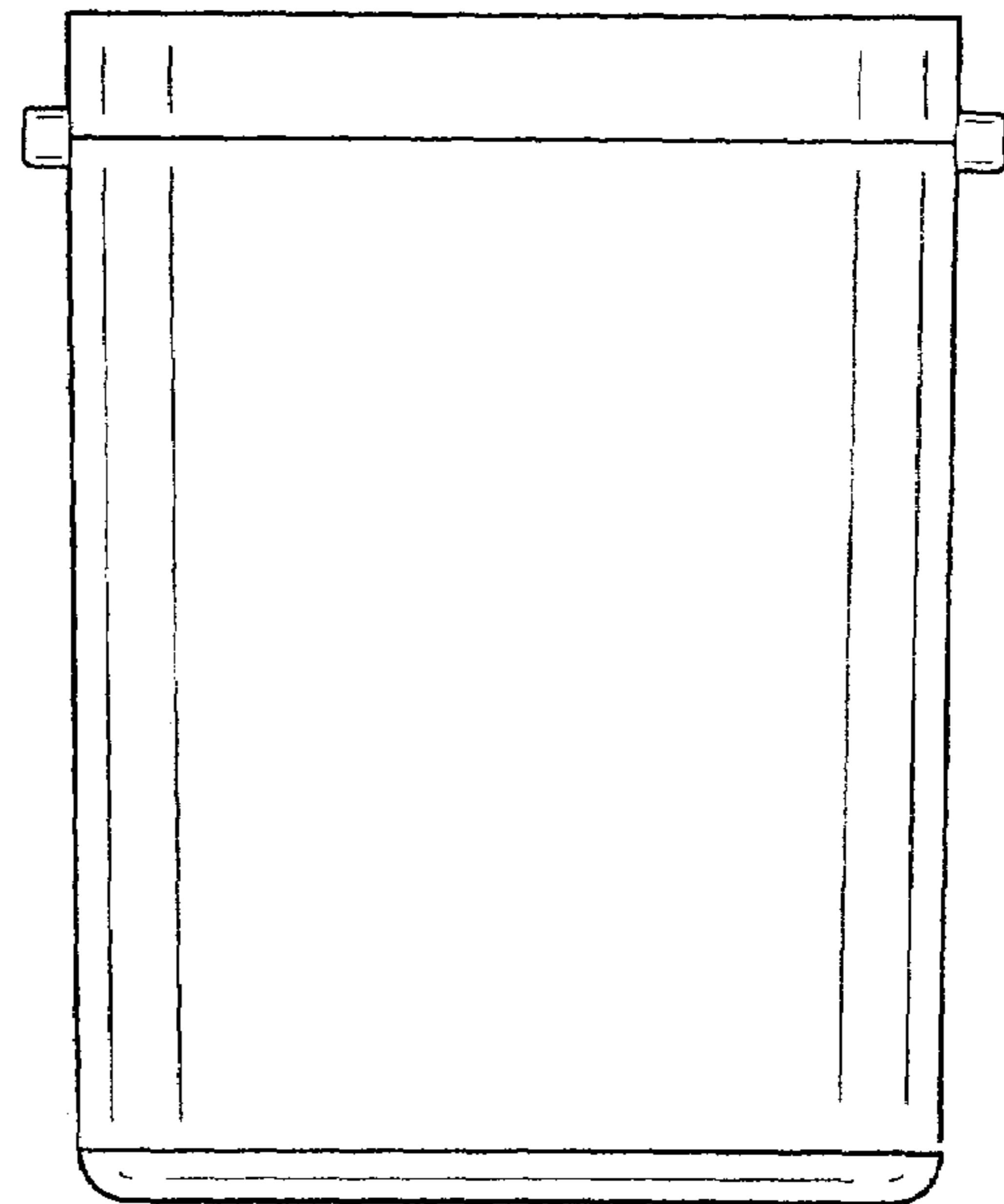
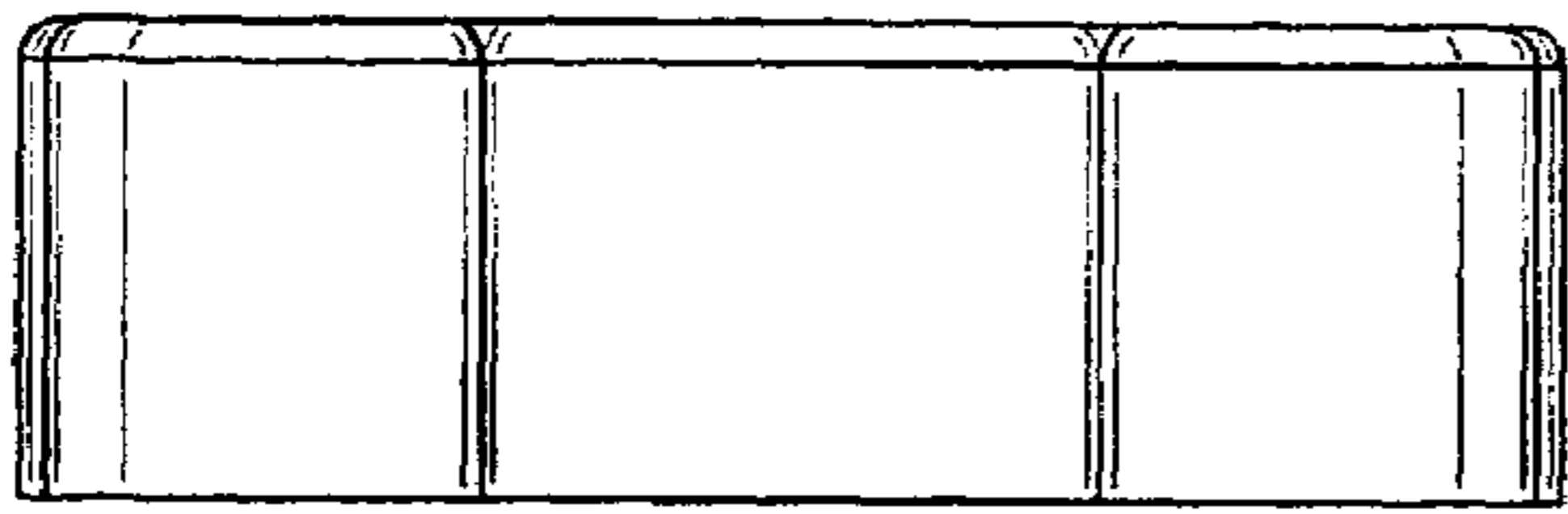

FIG. 3

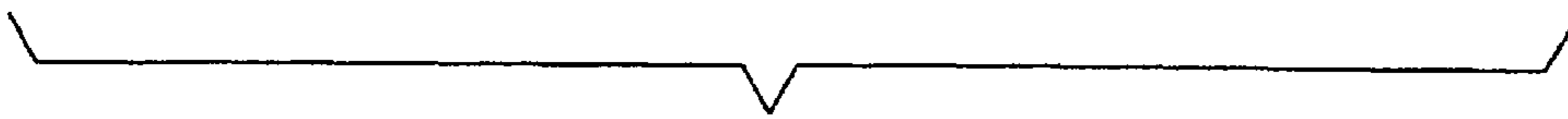
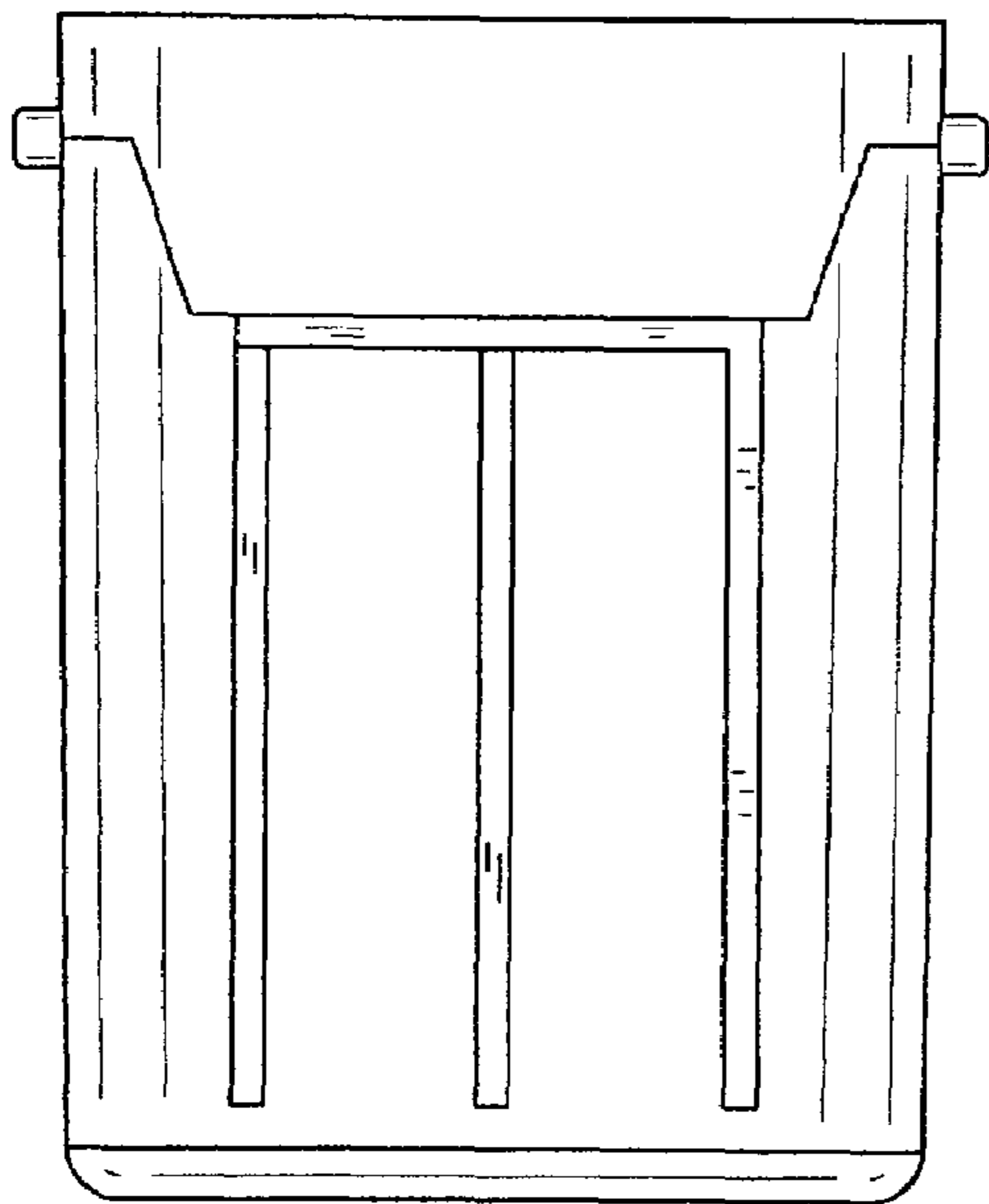
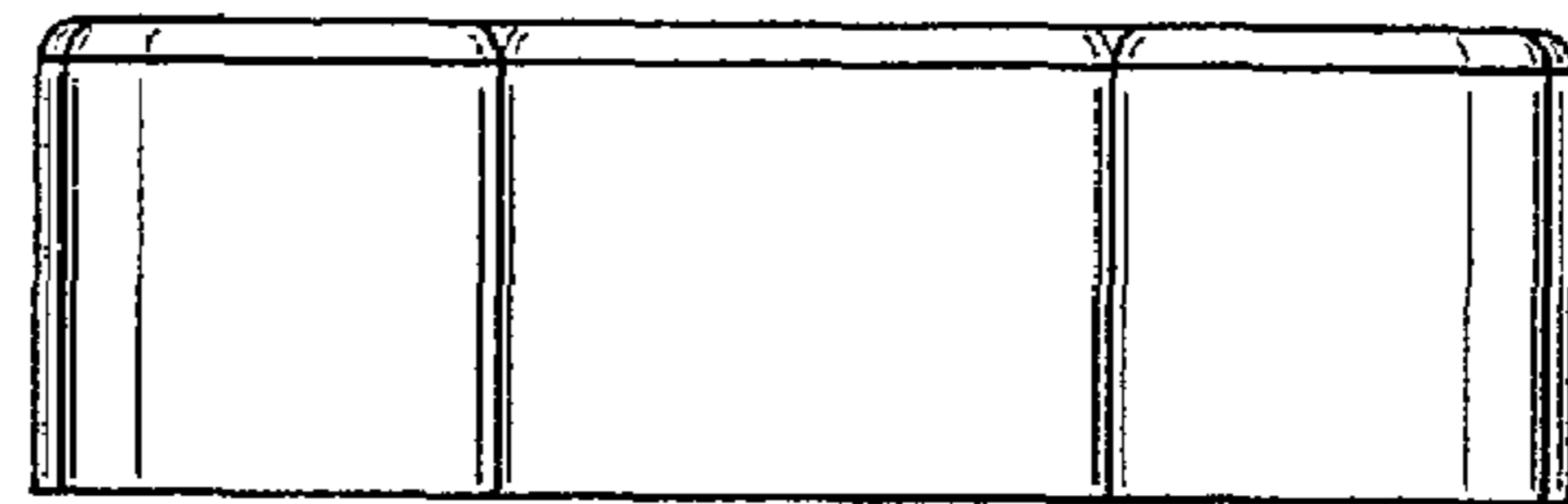
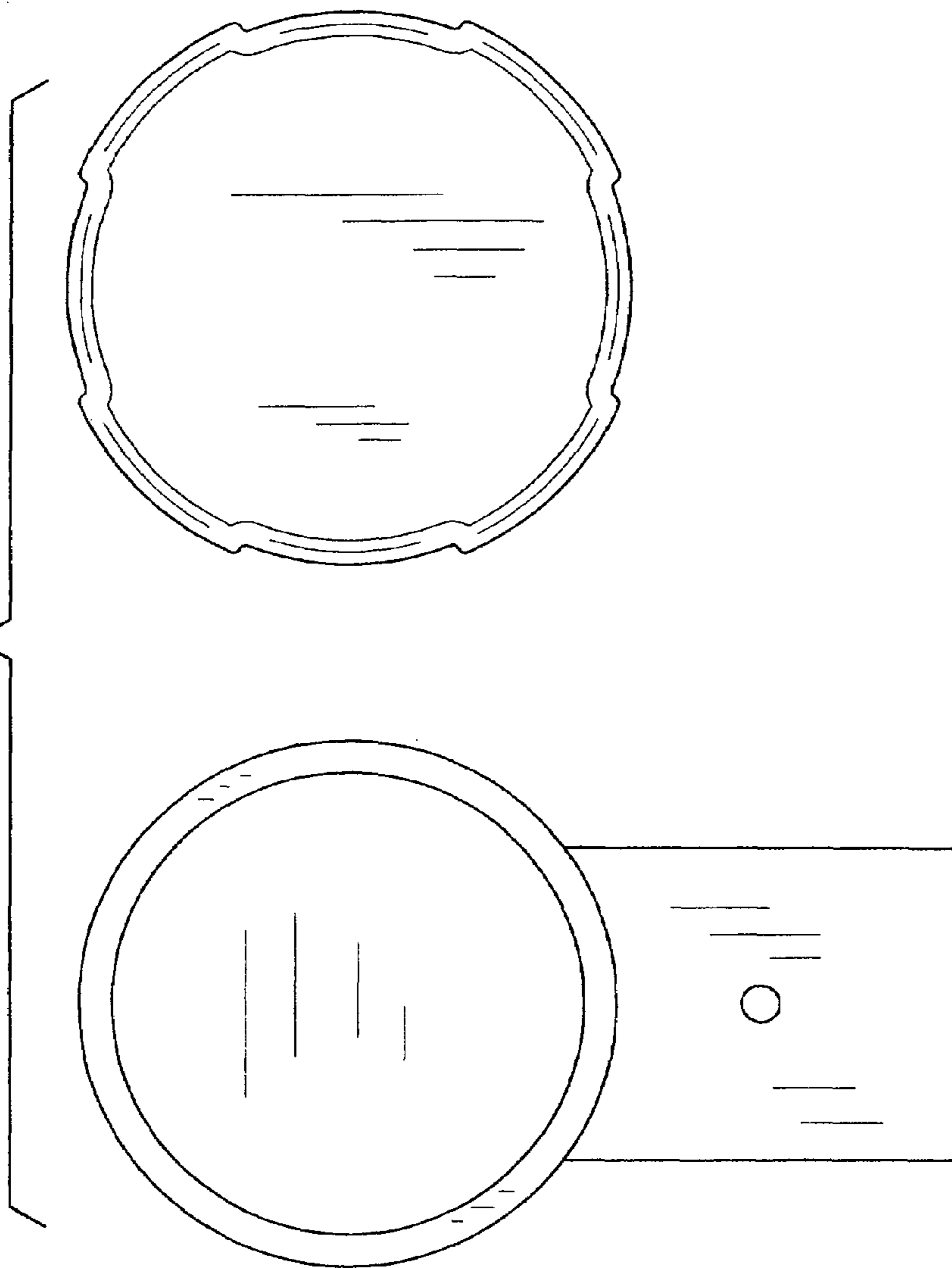

FIG. 4

FIG. 5



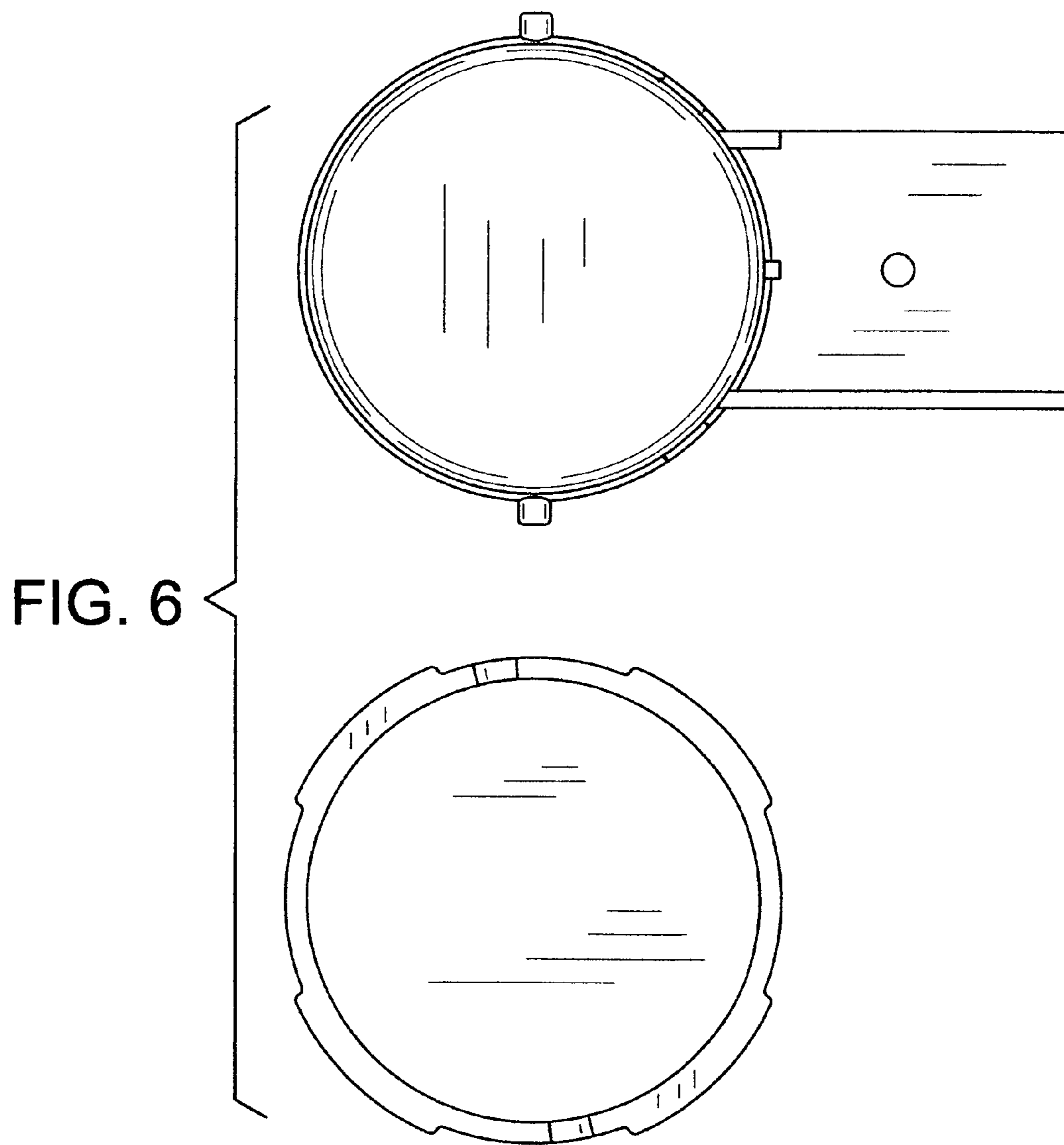

FIG. 7

