



US00D606705S

(12) **United States Design Patent**  
**Weis**

(10) **Patent No.:** **US D606,705 S**

(45) **Date of Patent:** **\*\* Dec. 22, 2009**

(54) **SET OF PUMICE PADS**

(76) **Inventor:** **Kathryn D. Weis**, P.O. Box 70, Danbury,  
WI (US) 54830

(\*\*) **Term:** **14 Years**

(21) **Appl. No.:** **29/312,488**

(22) **Filed:** **Oct. 23, 2008**

(51) **LOC (9) Cl.** ..... **28-03**

(52) **U.S. Cl.** ..... **D28/59**

(58) **Field of Classification Search** ..... 132/73-76.5;  
D28/56-62; D24/147

See application file for complete search history.

(56) **References Cited**

**U.S. PATENT DOCUMENTS**

1,534,214	A	4/1925	Holt	
4,336,293	A	6/1982	Eiden	
4,459,987	A	7/1984	Pangburn	
4,712,552	A	12/1987	Pangburn	
4,931,330	A	6/1990	Stier et al.	
5,575,034	A	11/1996	Biernacinski et al.	
D393,726	S *	4/1998	Sweeney	D28/56
6,142,156	A	11/2000	Brunderman	
D440,711	S *	4/2001	Archambeault	D28/56
6,530,096	B1	3/2003	Mayhew et al.	
D473,018	S *	4/2003	Ford	D28/56

D506,853	S *	6/2005	Woods	D28/59
D524,441	S *	7/2006	Anderson et al.	D24/147
D577,153	S *	9/2008	Falk	D28/59
2006/0196520	A1 *	9/2006	Anderson et al.	132/76.4
2007/0119470	A1 *	5/2007	Zepeda	132/76.4
2008/0216855	A1 *	9/2008	Nasca	132/76.5

\* cited by examiner

*Primary Examiner*—Jennifer Rivard

(74) *Attorney, Agent, or Firm*—Robert C. Montgomery

(57) **CLAIM**

The ornamental design for the set of pumice pads, as shown and described.

**DESCRIPTION**

FIG. 1 is a perspective view of a left-foot and a right-foot embodiment of a set of pumice pads as shown and described;

FIG. 2 is a front view thereof;

FIG. 3 is a rear view thereof;

FIG. 4 is a left side view thereof;

FIG. 5 is a right side view thereof;

FIG. 6 is a top view thereof; and,

FIG. 7 is a bottom view thereof.

**1 Claim, 5 Drawing Sheets**

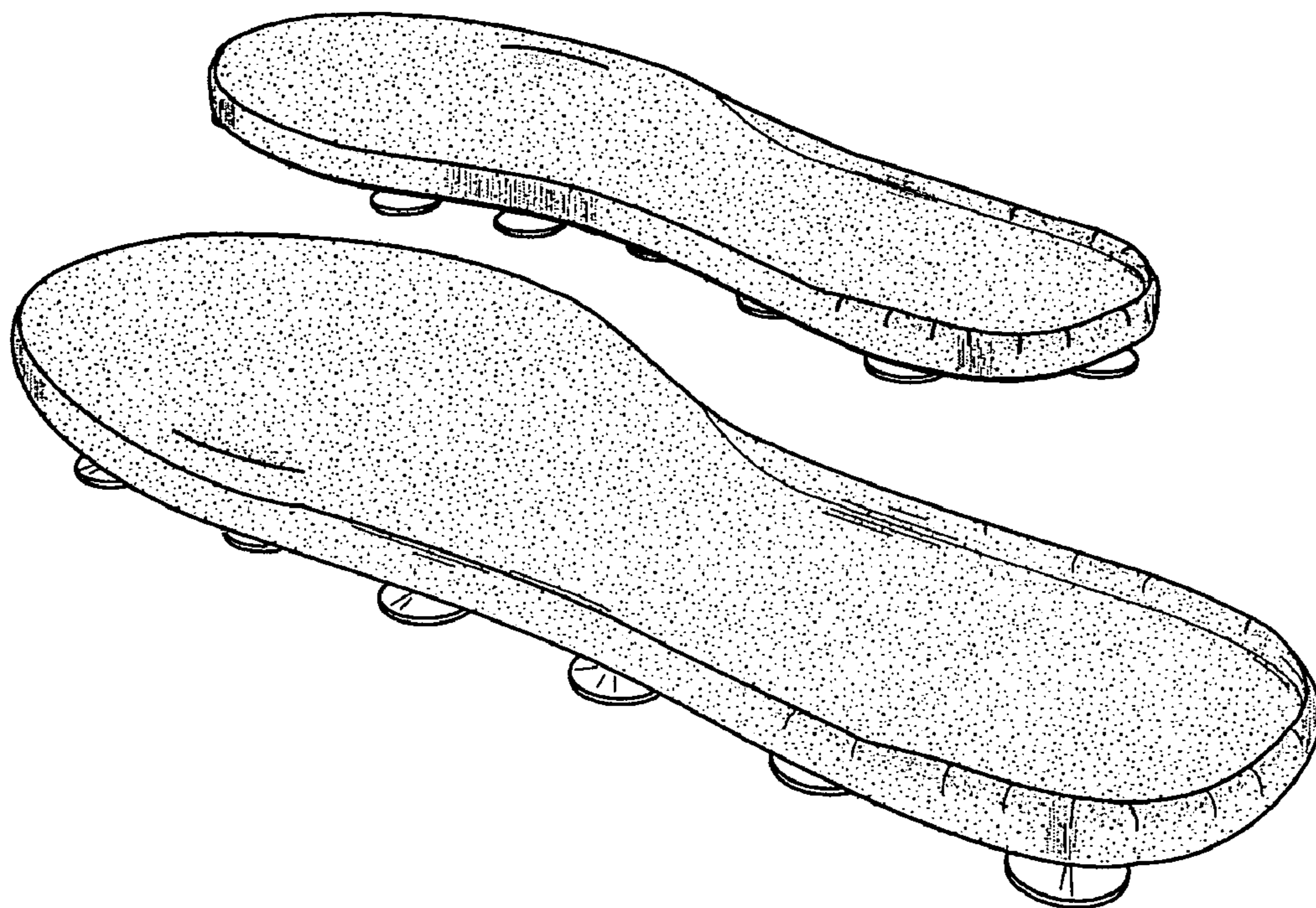

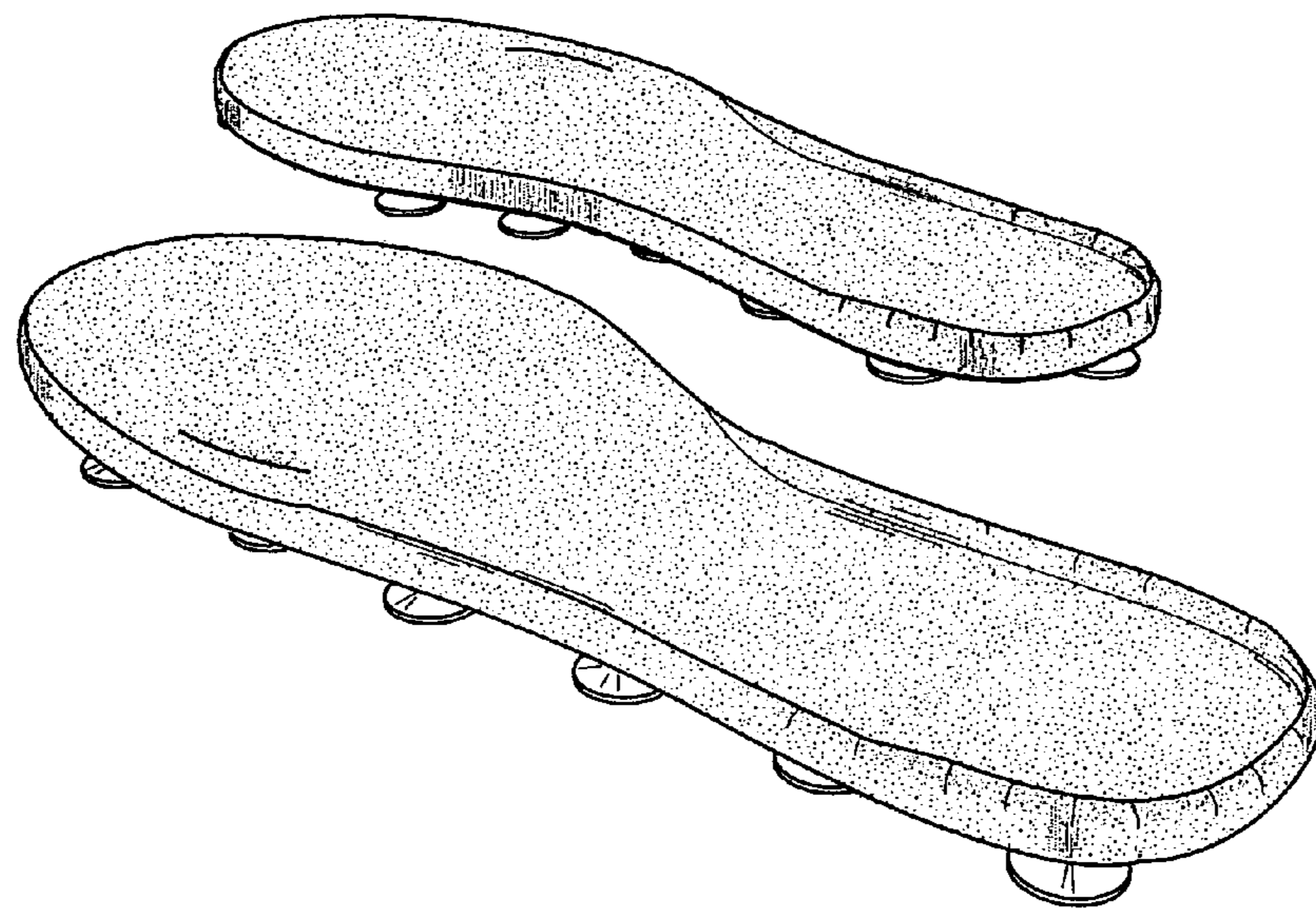

Fig. 1

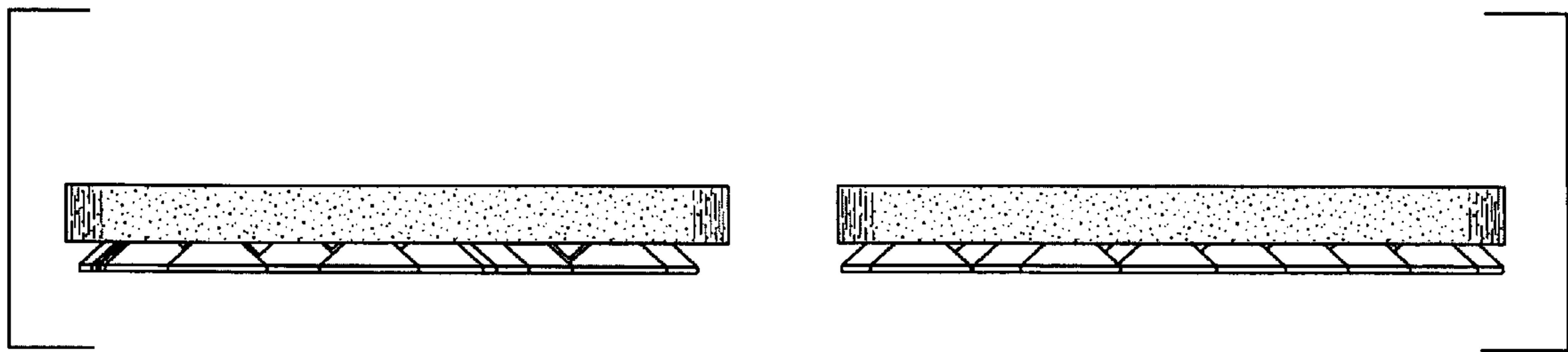

Fig. 2

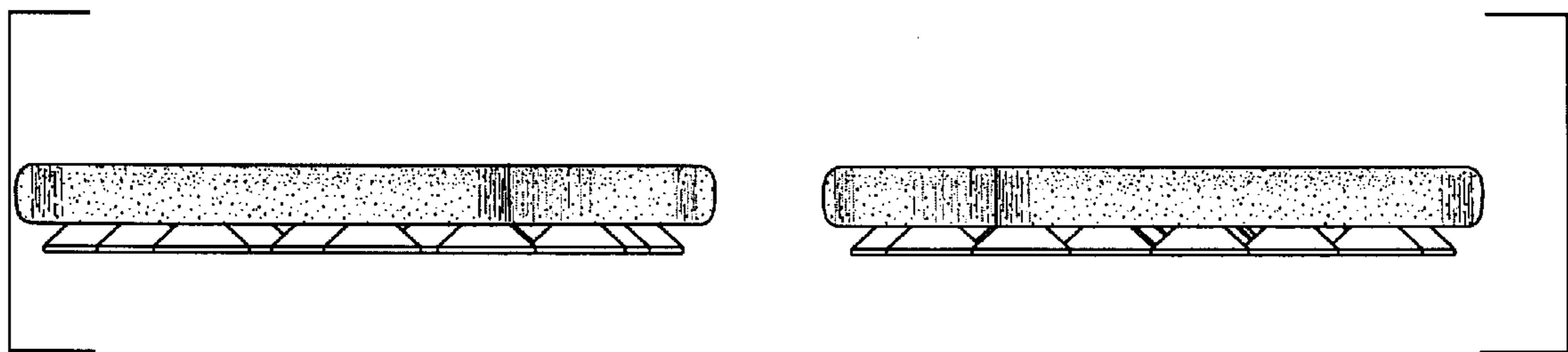

Fig. 3

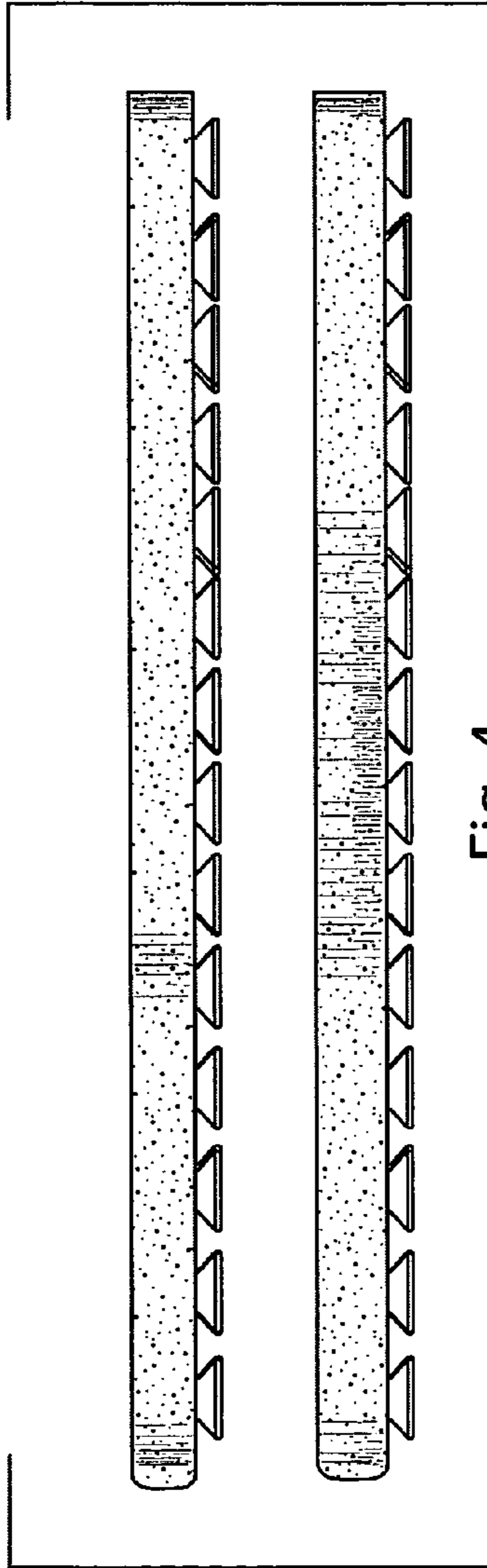

Fig. 4

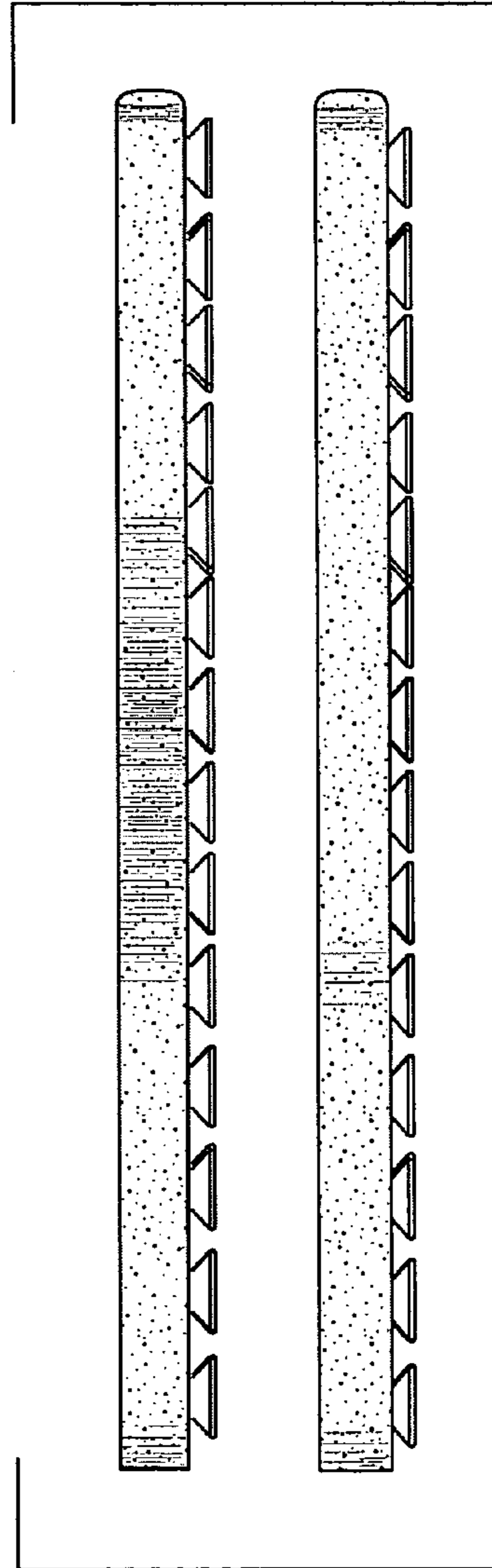

Fig. 5

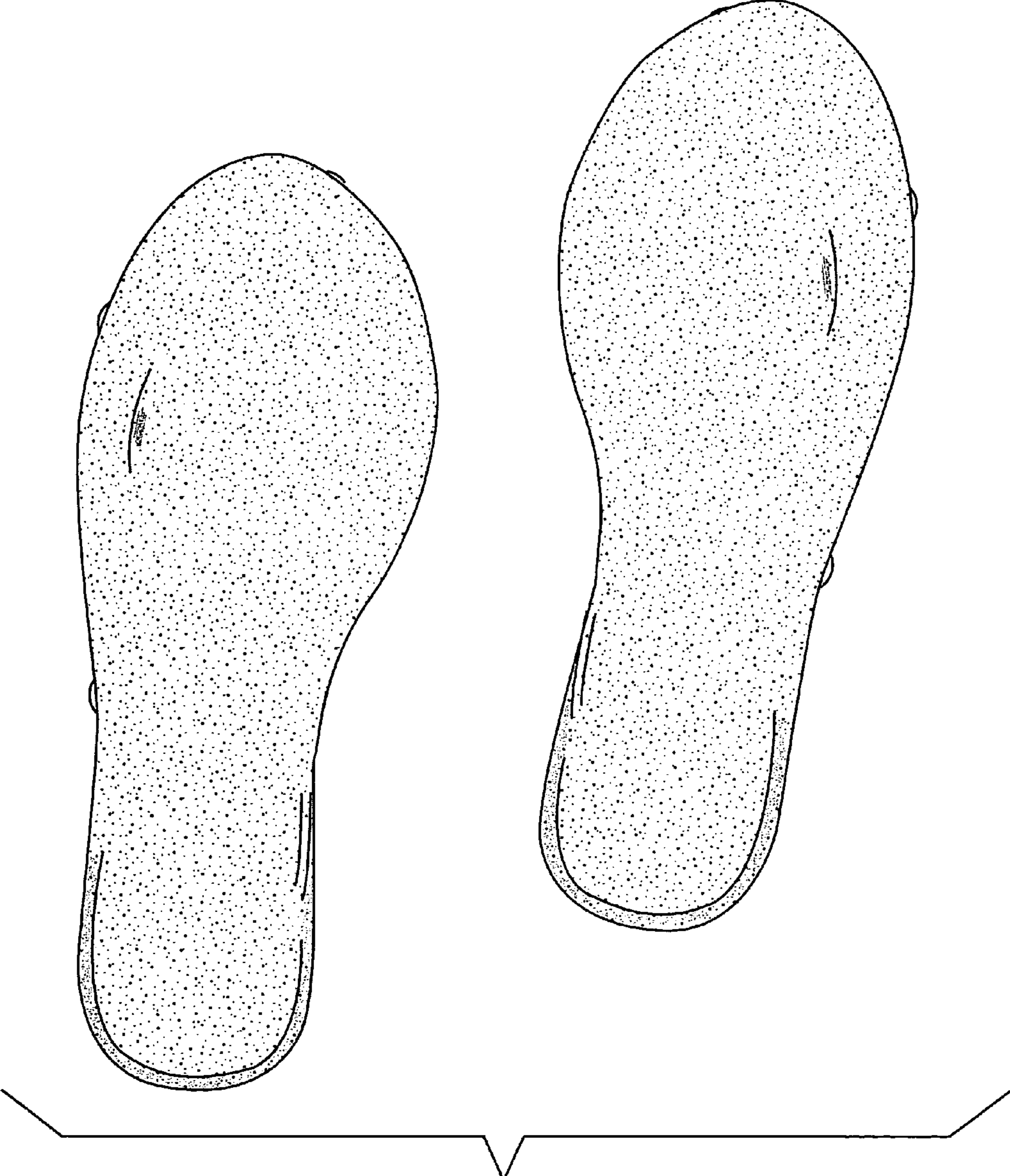

Fig. 6

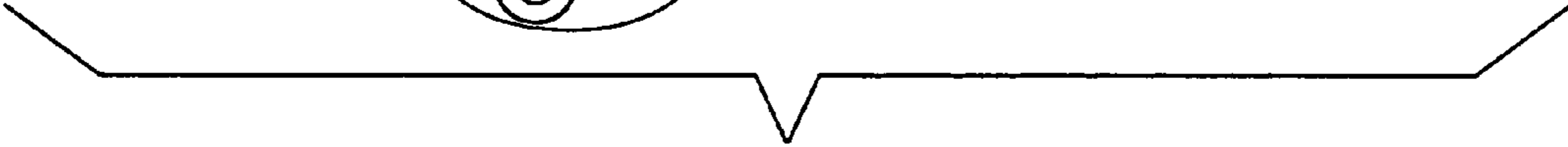
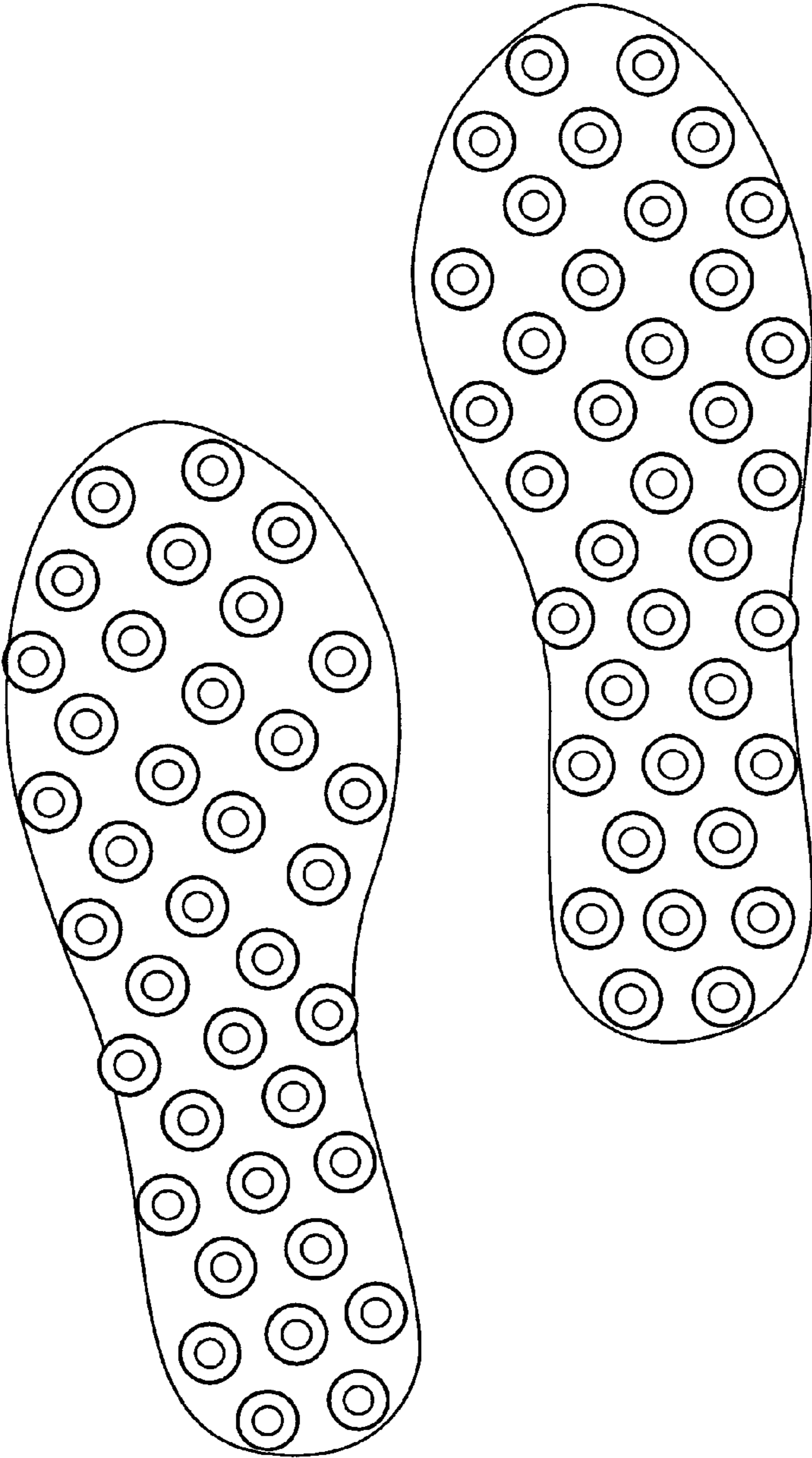

Fig. 7