



US00D606658S

(12) **United States Design Patent**
Blanco-Acevedo

(10) **Patent No.:** **US D606,658 S**

(45) **Date of Patent:** **** Dec. 22, 2009**

(54) **SET OF SIMULATIVE PADS FOR ORTHODONTIC BRACKETS**

(74) *Attorney, Agent, or Firm*—Jason A. Bernstein; Barnes & Thomburg LLP

(76) Inventor: **Maria Carolina Blanco-Acevedo**, 1691 Grist Mill Dr., Marietta, GA (US) 30062

(57) **CLAIM**

(**) Term: **14 Years**

The ornamental design for set of simulative pads for orthodontic brackets, as shown and described.

(21) Appl. No.: **29/324,579**

DESCRIPTION

(22) Filed: **Sep. 16, 2008**

FIG. 1 is a perspective view of one member of a set of simulative pads for orthodontic brackets showing my new design;

(51) **LOC (9) Cl.** **24-04**

(52) **U.S. Cl.** **D24/180**

(58) **Field of Classification Search** D24/155, D24/156, 180, 176; D8/387, 176; 433/173, 433/176, 18, 174, 11, 9; 606/304, 74, 72; D21/388, 389

FIG. 2 is a top plan view thereof shown on a reduced scale;

FIG. 3 is a front elevation thereof;

FIG. 4 is a side elevation thereof the side opposite being a mirror image;

See application file for complete search history.

FIG. 5 is a bottom plan view thereof;

FIG. 6 is a rear elevation thereof;

(56) **References Cited**

U.S. PATENT DOCUMENTS

FIG. 7 is a perspective view of a second member of a set of simulative pads for orthodontic brackets;

FIG. 8 is a top plan view thereof shown on a reduced scale;

FIG. 9 is a front elevation thereof;

D123,570	S	*	11/1940	Goldin	D21/389
D197,525	S	*	2/1964	Hanna et al.	D21/389
4,355,975	A	*	10/1982	Fujita	433/11
D290,040	S		5/1987	Kelly		
D291,919	S		9/1987	Reynolds		
D331,975	S		12/1992	Pospisil		
D354,524	S	*	1/1995	Freund	D21/389
D367,116	S		2/1996	Viazis		
D412,363	S		7/1999	Stevens		
D412,579	S		8/1999	Stevens		
D412,988	S		8/1999	Stevens		
5,967,773	A	*	10/1999	Roman et al.	433/11
D444,238	S		6/2001	Stevens		
D447,804	S	*	9/2001	Stevens	D24/180
6,488,498	B1	*	12/2002	Mariani, Jr.	433/11
6,712,607	B2	*	3/2004	Andreiko	433/9
6,846,178	B2	*	1/2005	Freeman et al.	433/9
7,186,114	B2	*	3/2007	Navarro et al.	433/11
7,204,691	B2		4/2007	Darling et al.		
7,214,057	B2	*	5/2007	Voudouris	433/11

FIG. 10 is a side elevation thereof the side opposite being a mirror image;

FIG. 11 is a bottom plan view thereof;

FIG. 12 is a rear elevation thereof;

FIG. 13 is a perspective view of a third member of a set of simulative pads for orthodontic brackets;

FIG. 14 is a top plan view thereof shown on a reduced scale;

FIG. 15 is a front elevation thereof;

FIG. 16 is a side elevation thereof the side opposite being a mirror image;

FIG. 17 is a bottom plan view thereof;

FIG. 18 is a rear elevation thereof;

FIG. 19 is a perspective view of a fourth member of a set of simulative pads for orthodontic brackets;

FIG. 20 is a top plan view thereof shown on a reduced scale;

FIG. 21 is a front elevation thereof;

* cited by examiner

Primary Examiner—Charles A Rademaker

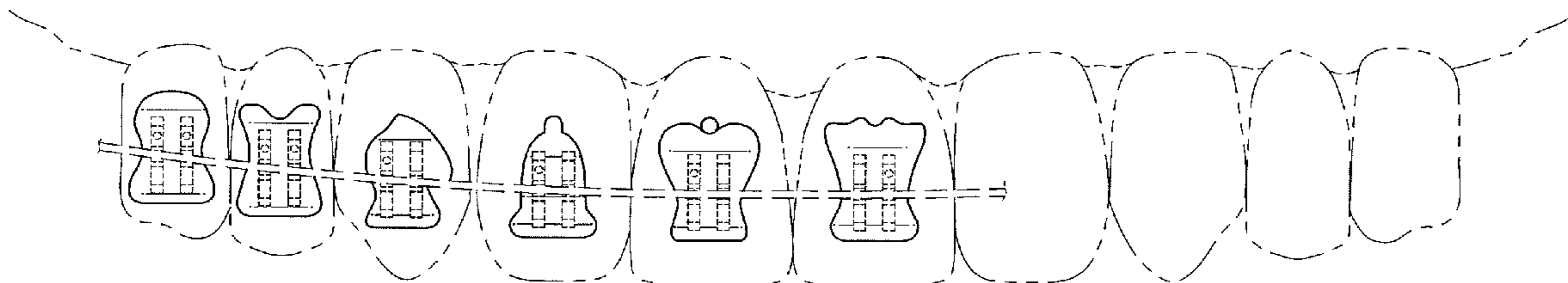

FIG. 22 is a side elevation shown from the left side thereof;
FIG. 23 is a side elevation shown from the right side thereof;
FIG. 24 is a bottom plan view thereof;
FIG. 25 is a rear elevation thereof;
FIG. 26 is a perspective view of a fifth member of a set of
simulative pads for orthodontic brackets;
FIG. 27 is a top plan view thereof shown on a reduced scale;
FIG. 28 is a front elevation thereof;
FIG. 29 is a side elevation thereof the side opposite being a
mirror image;
FIG. 30 is a bottom plan view thereof;
FIG. 31 is a rear elevation thereof;
FIG. 32 is a perspective view of a sixth member of a set of
simulative pads for orthodontic brackets;

FIG. 33 is a top plan view thereof shown on a reduced scale;
FIG. 34 is a front elevation thereof;
FIG. 35 is a side elevation thereof the side opposite being a
mirror image;
FIG. 36 is a bottom plan view thereof;
FIG. 37 is a rear elevation thereof; and,
FIG. 38 is perspective view of the members of the claimed
invention in one exemplary intended environment.

The broken lines shown in the figure drawings are included
for the purpose of illustrating environment and form no part
of the claimed design.

1 Claim, 13 Drawing Sheets

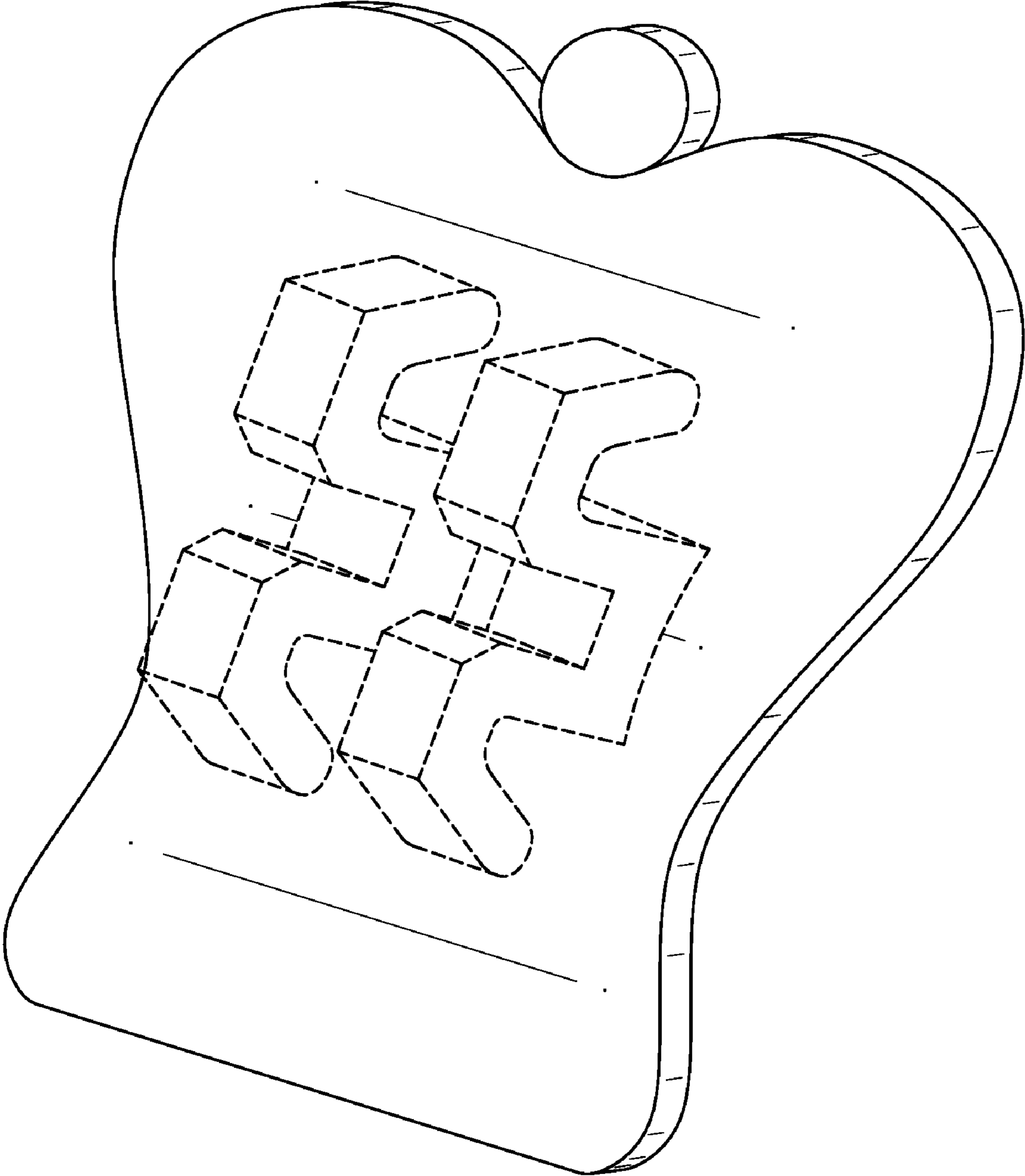

FIG.1

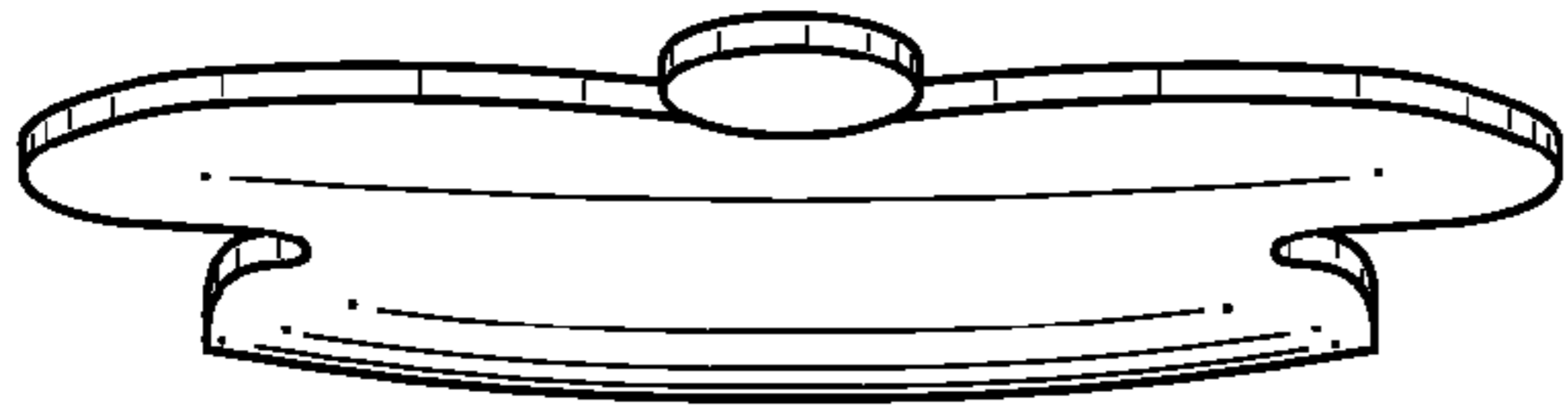

FIG. 2

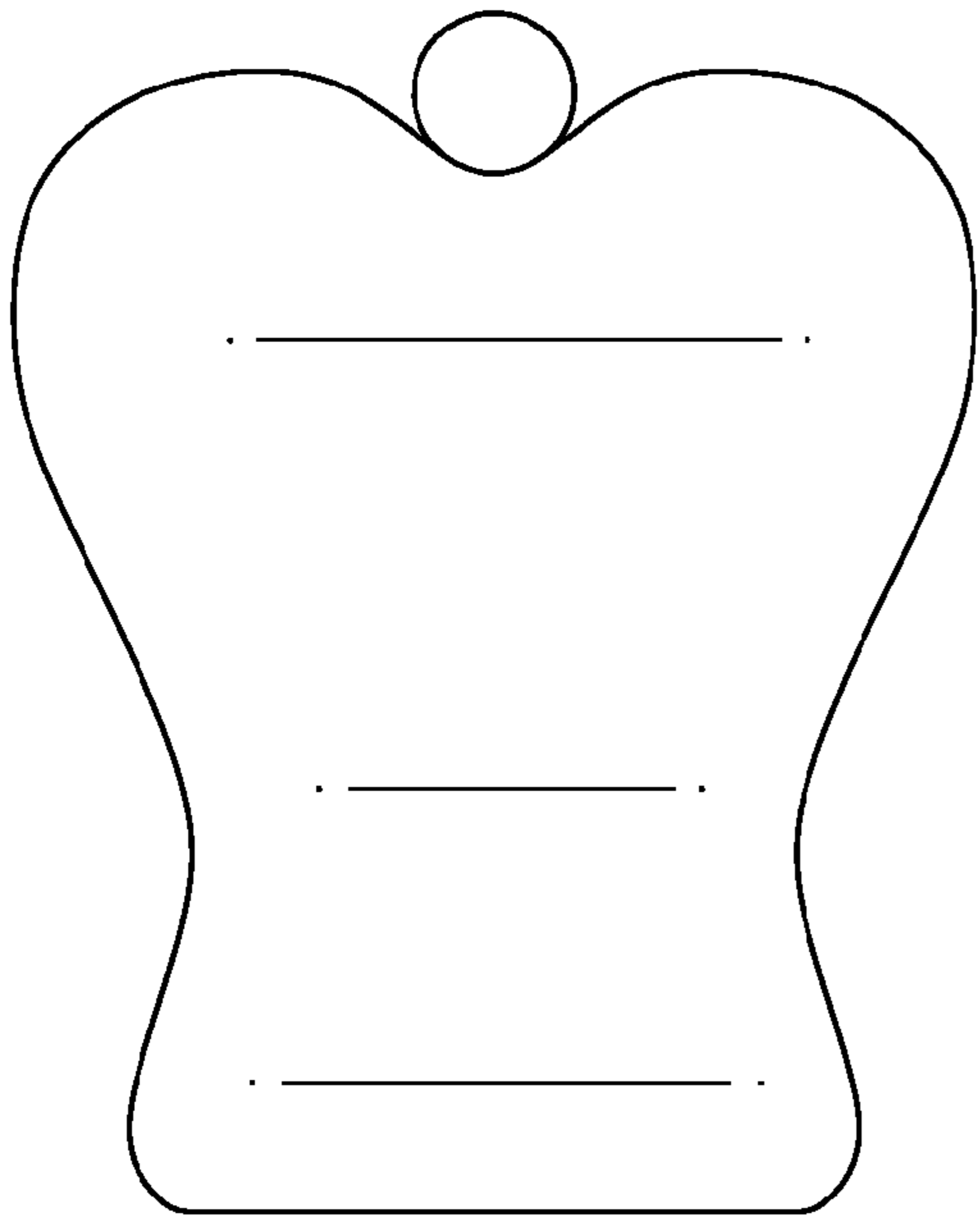

FIG. 3



FIG. 4

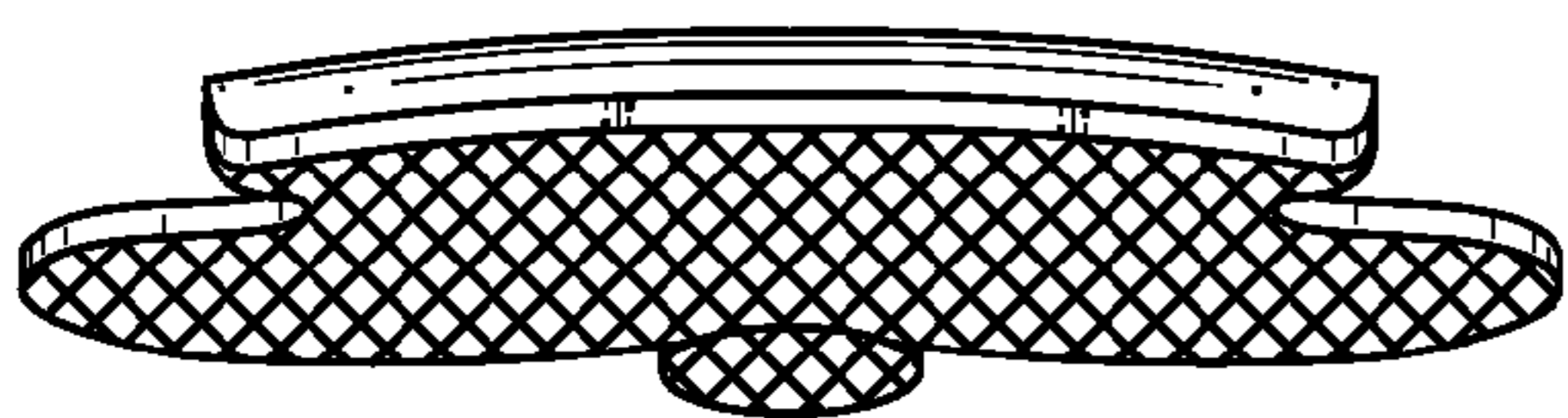

FIG. 5

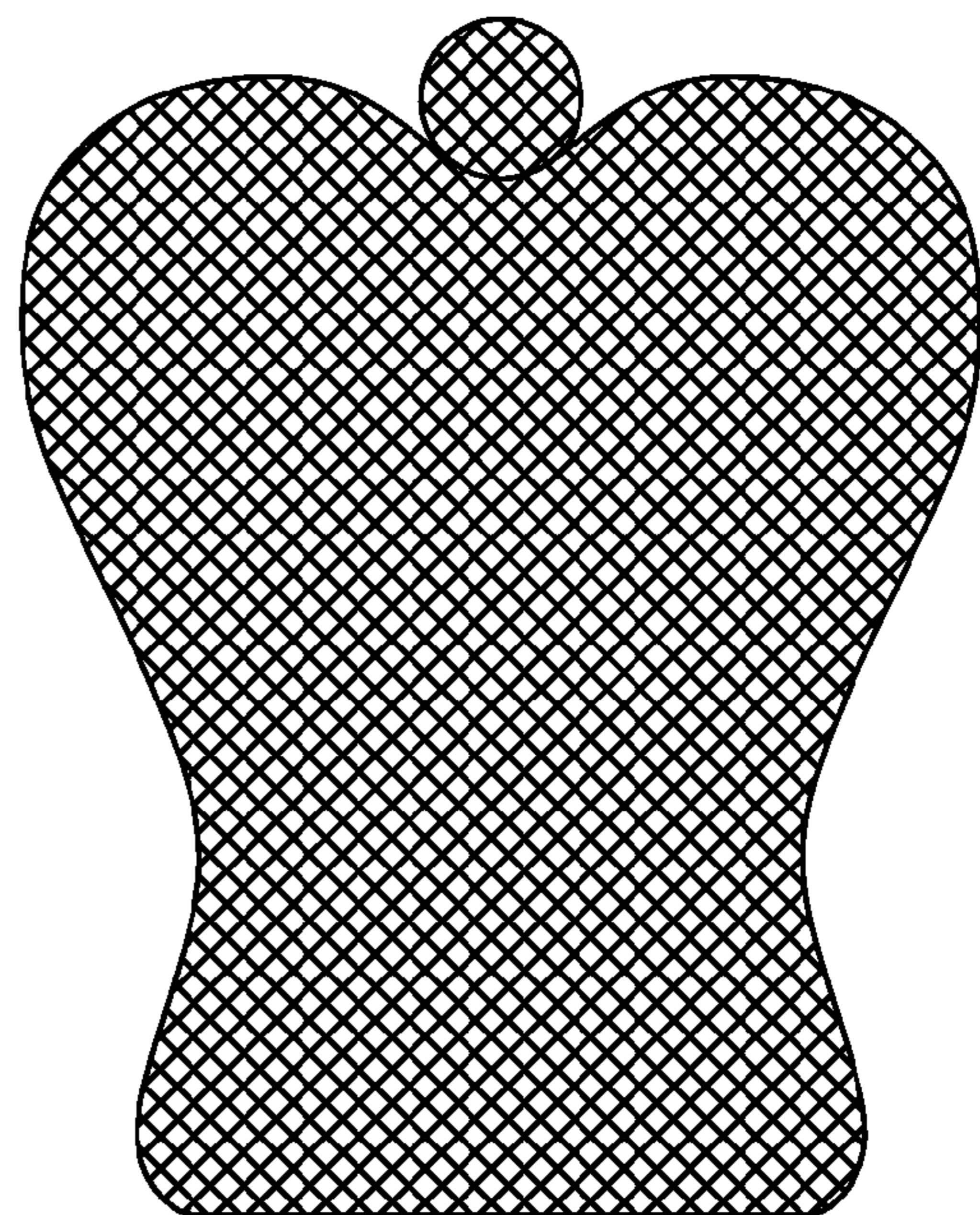

FIG. 6

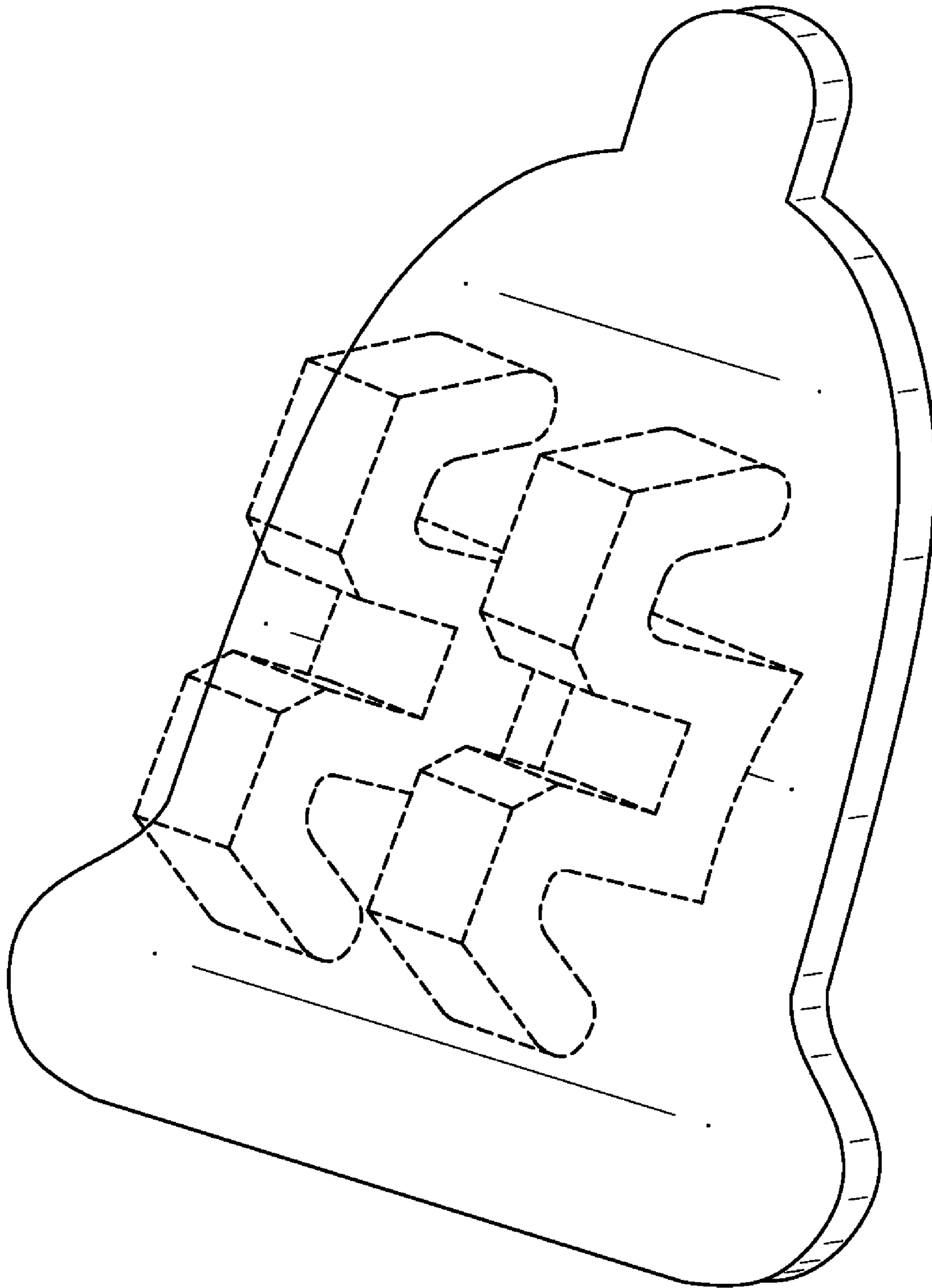

FIG.7

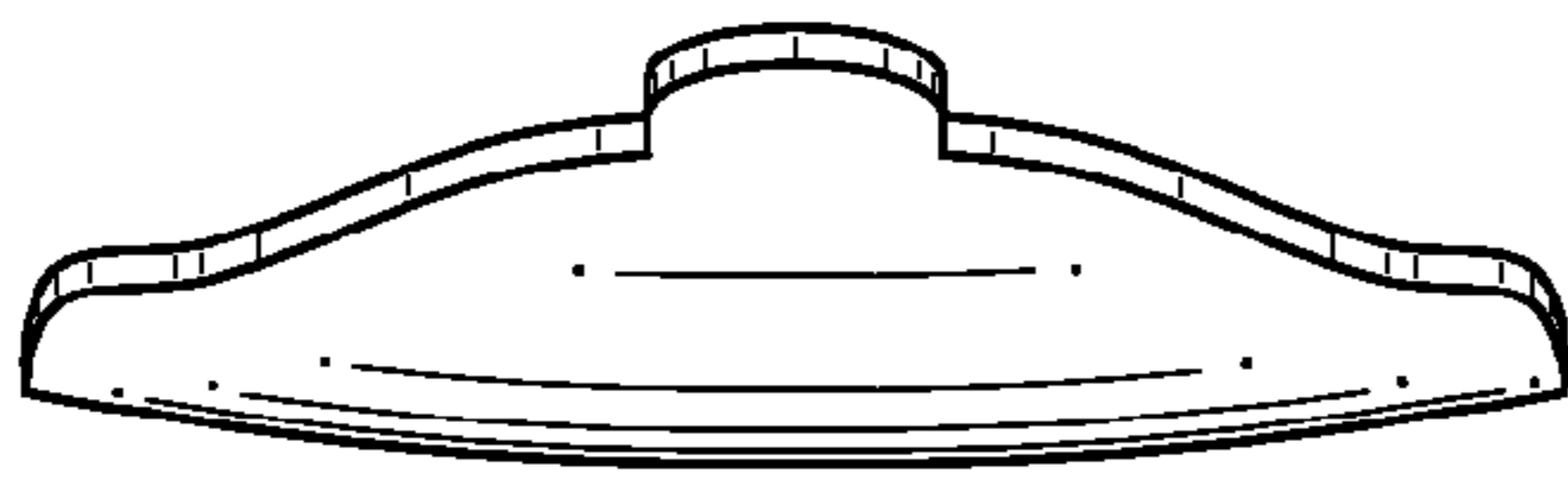

FIG. 8

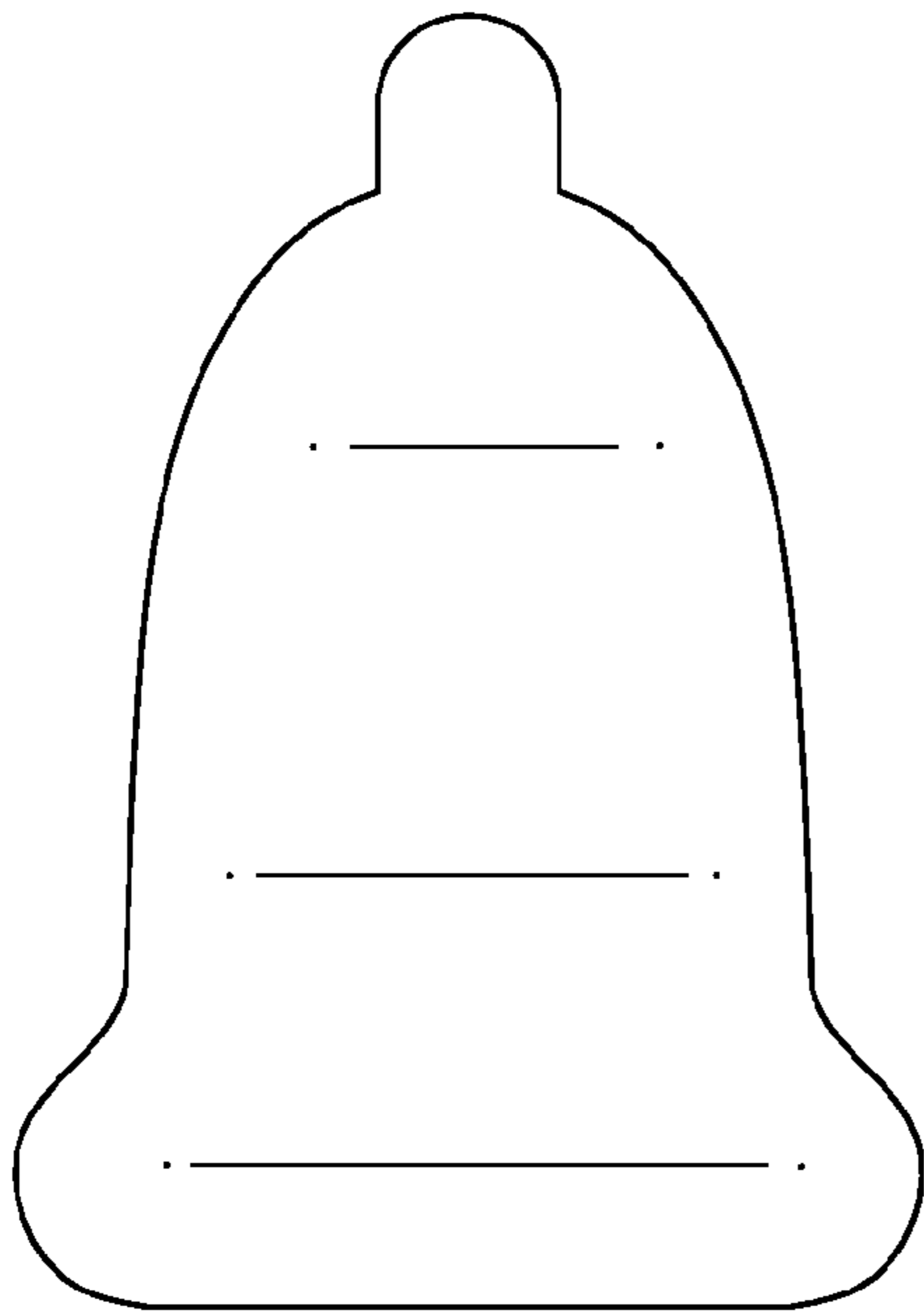

FIG. 9



FIG. 10

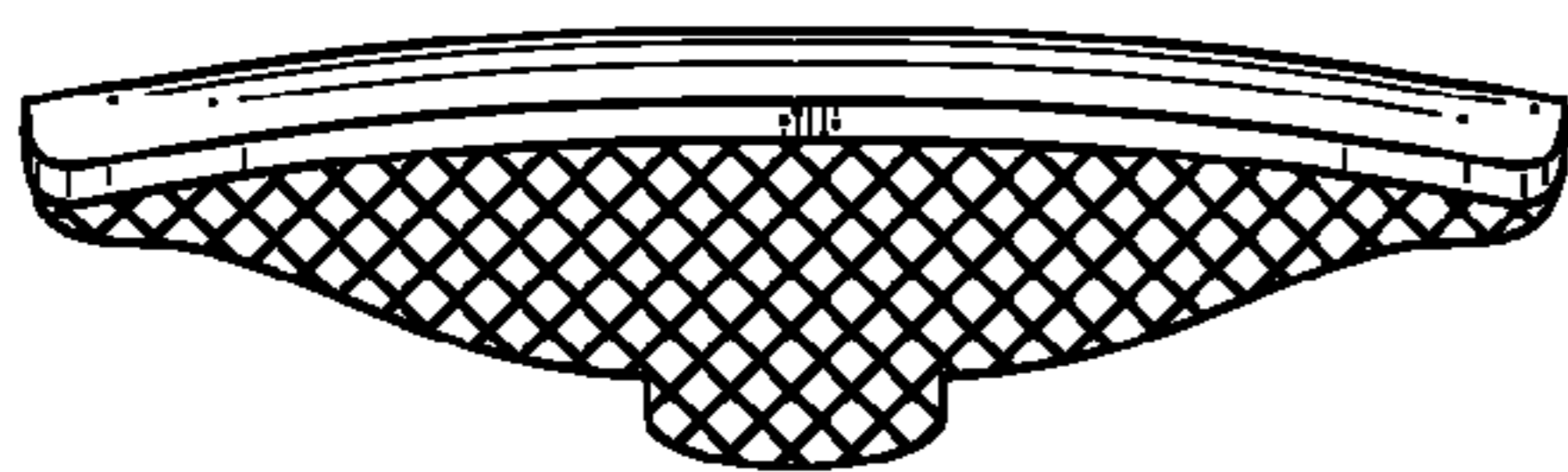

FIG. 11

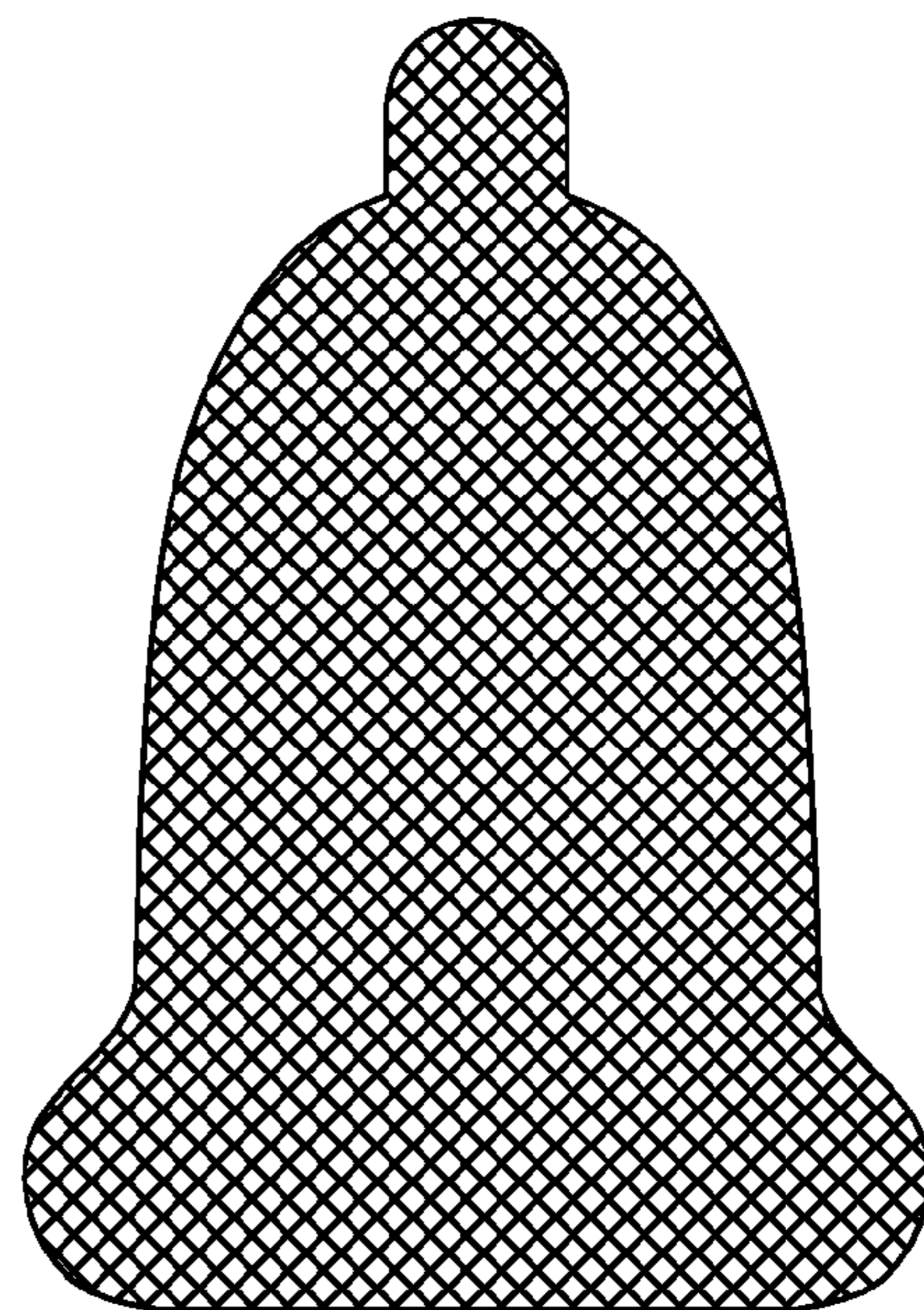

FIG. 12

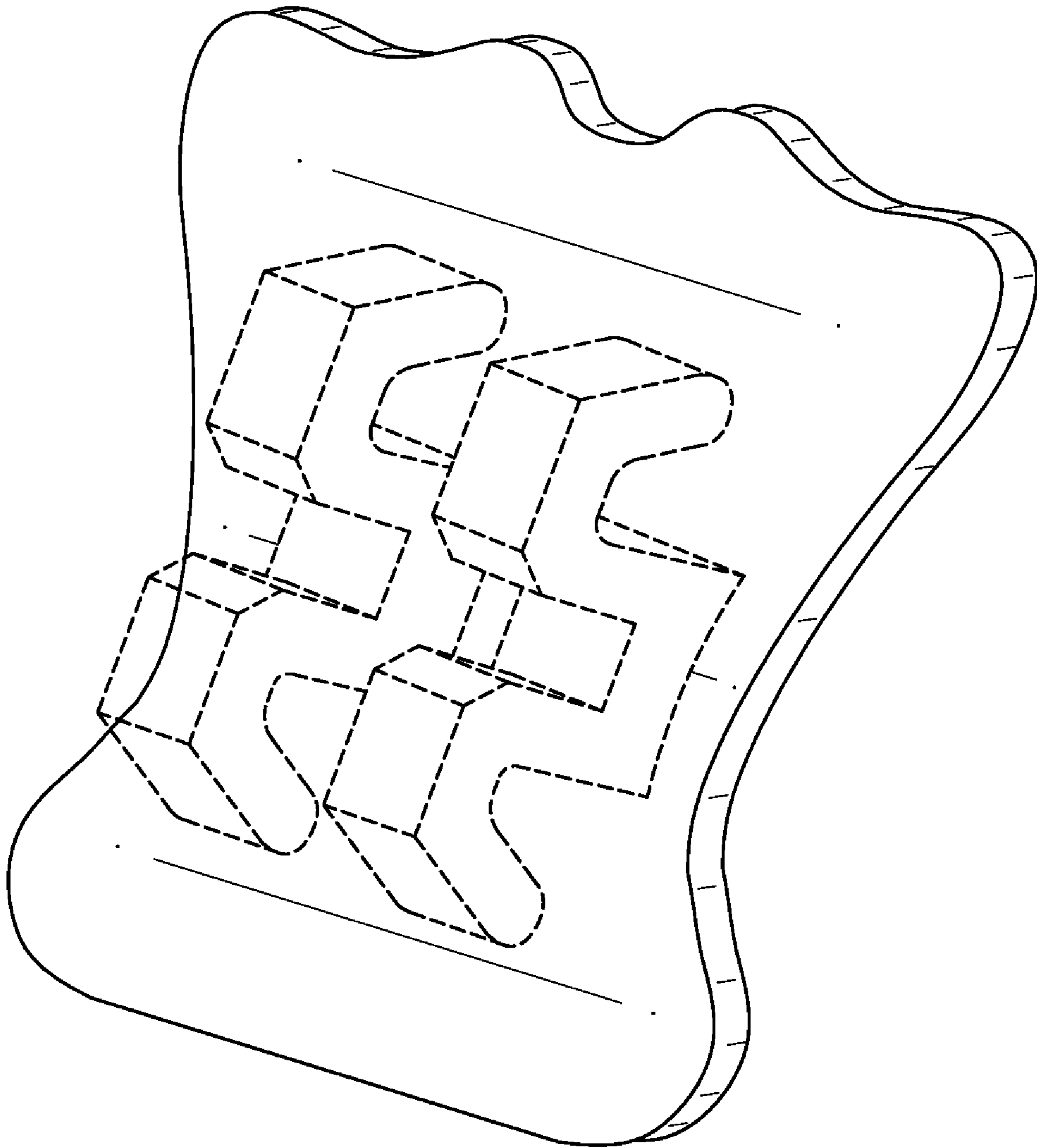

FIG.13

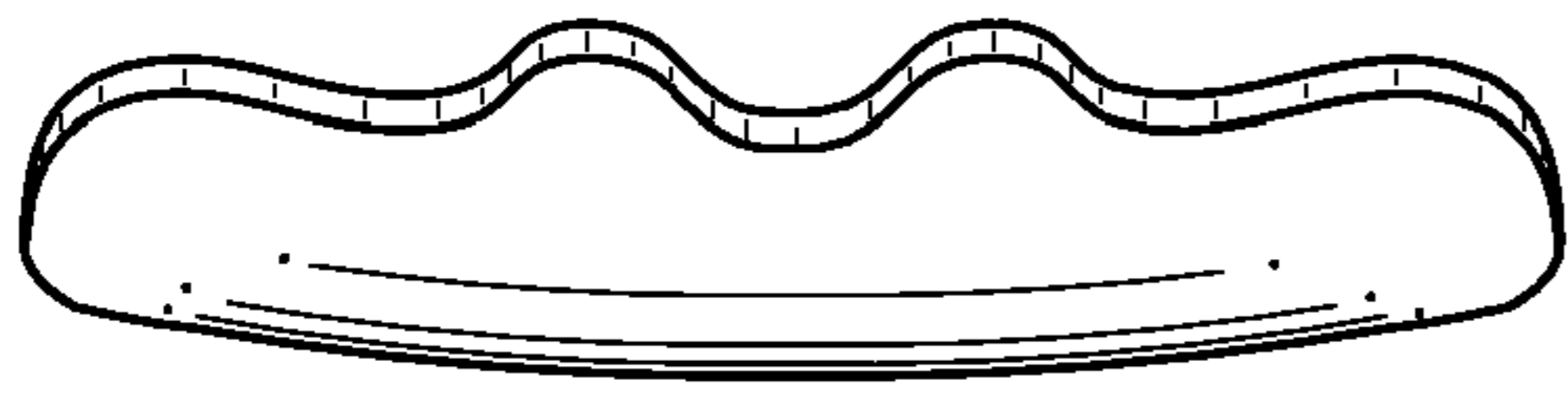

FIG. 14

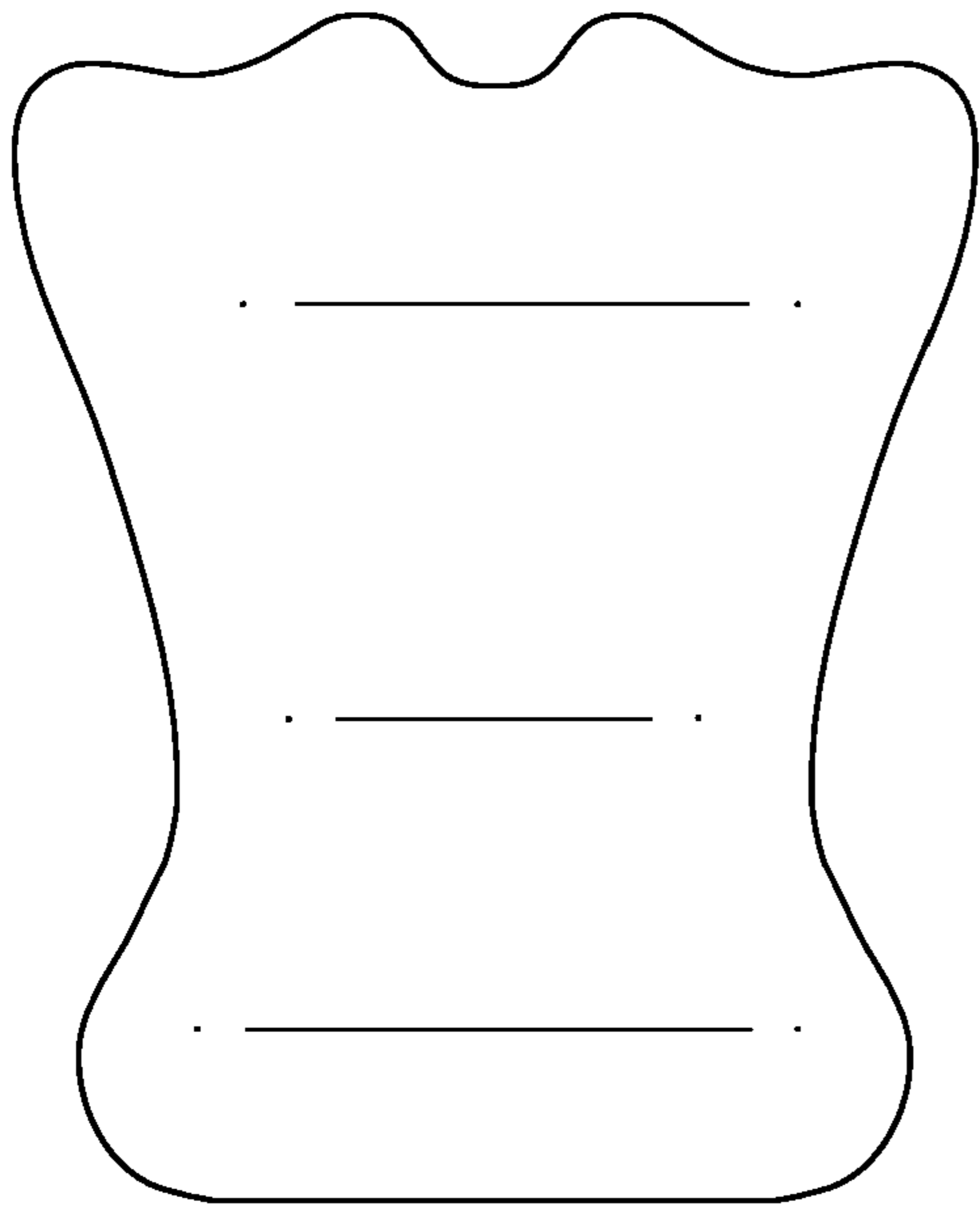

FIG. 15

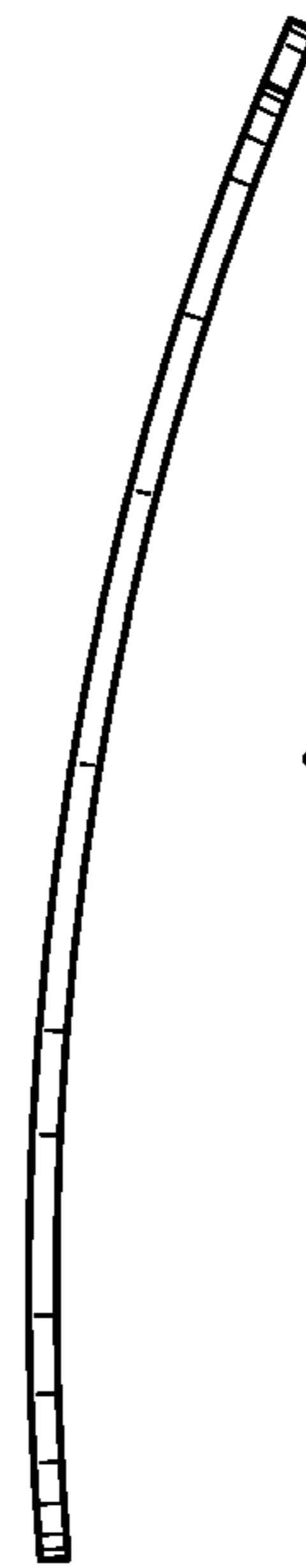

FIG. 16

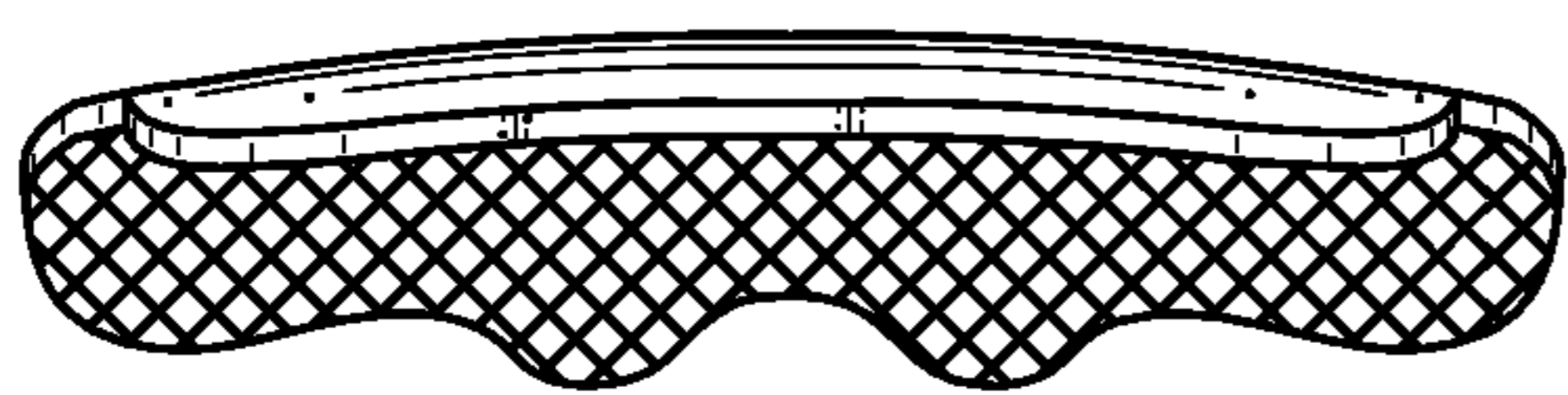

FIG. 17

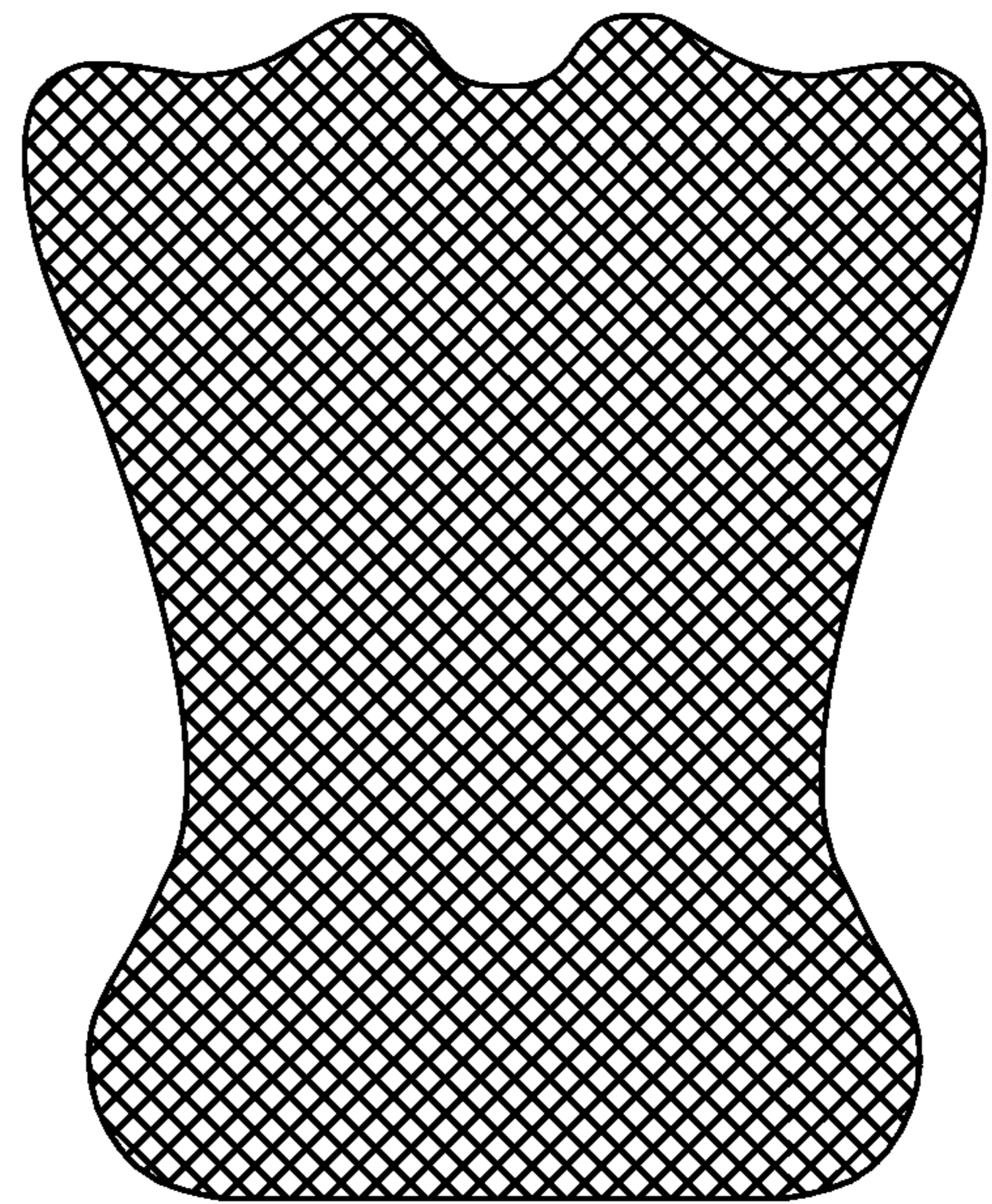

FIG. 18

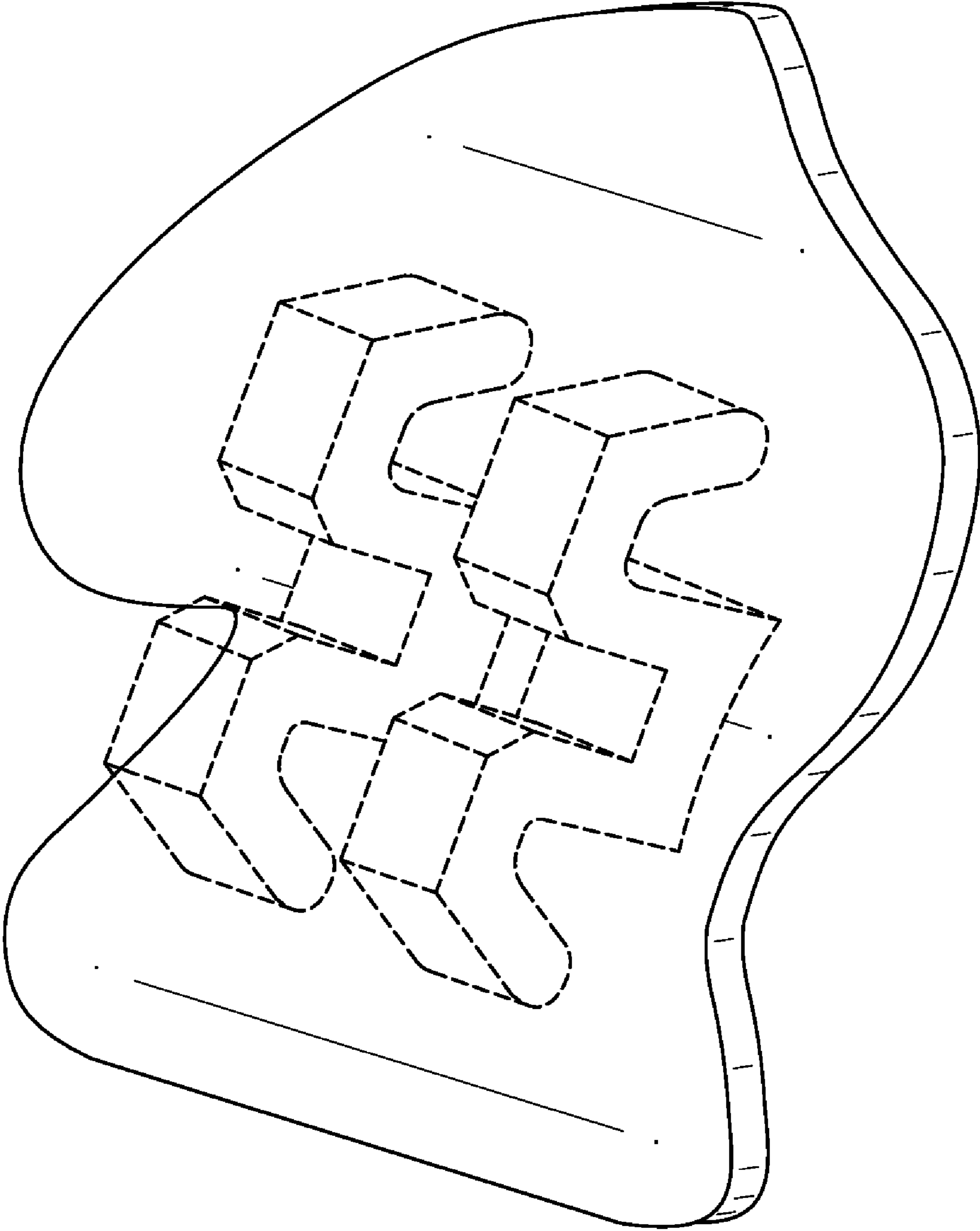

FIG.19

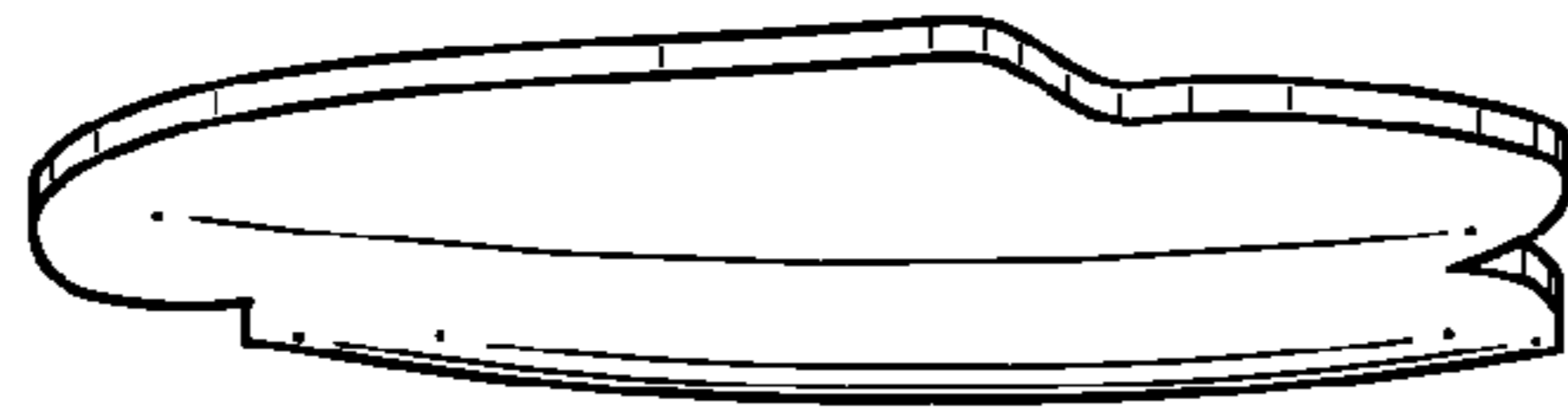

FIG. 20

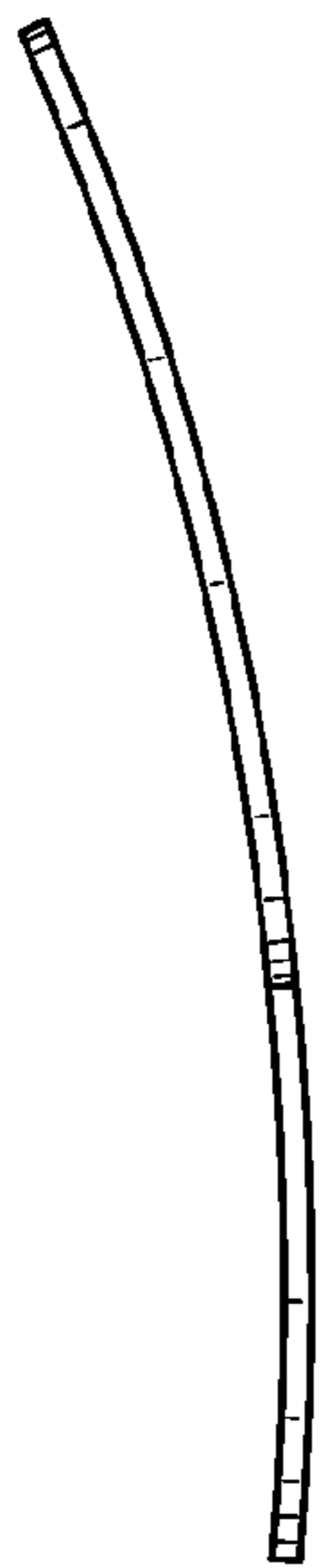

FIG. 22

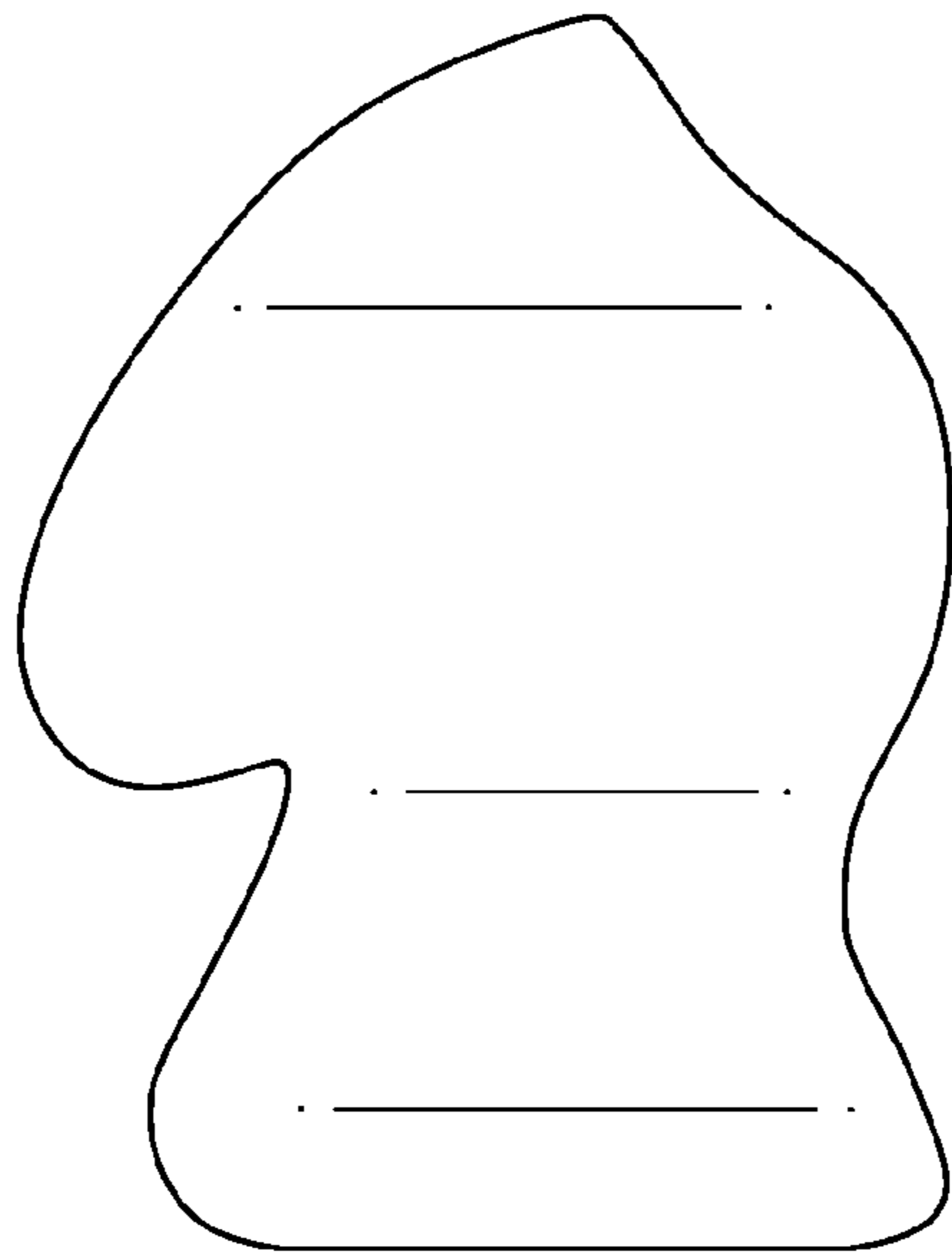

FIG. 21

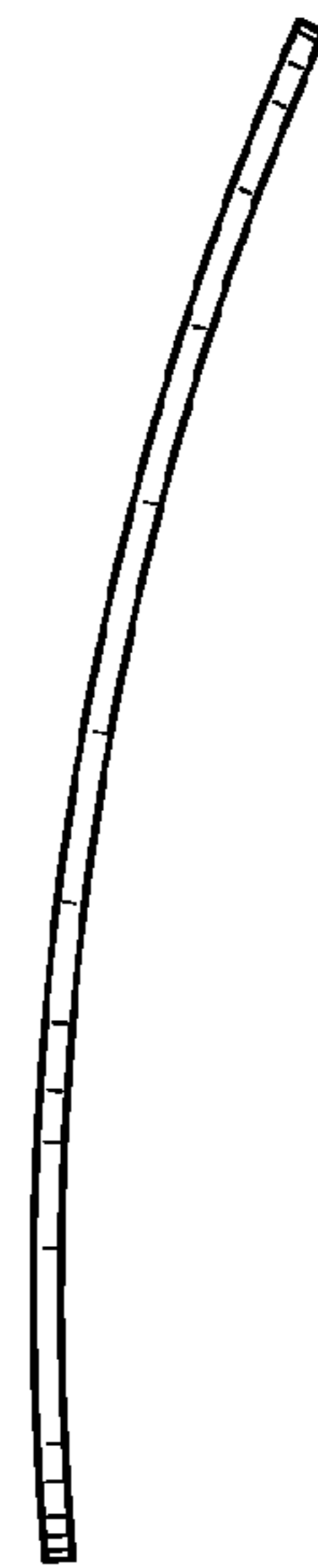

FIG. 23

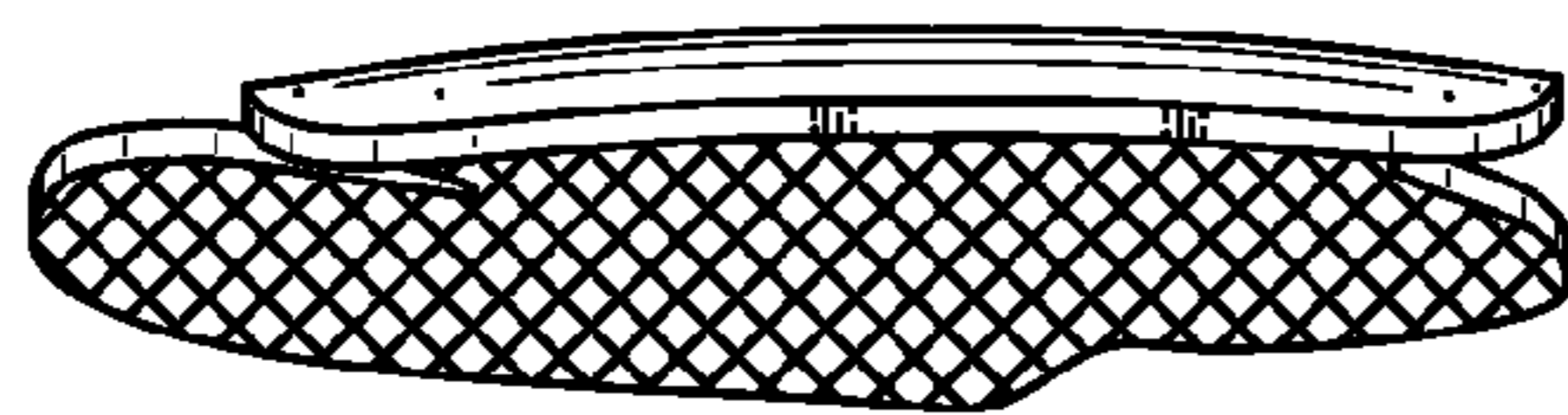

FIG. 24

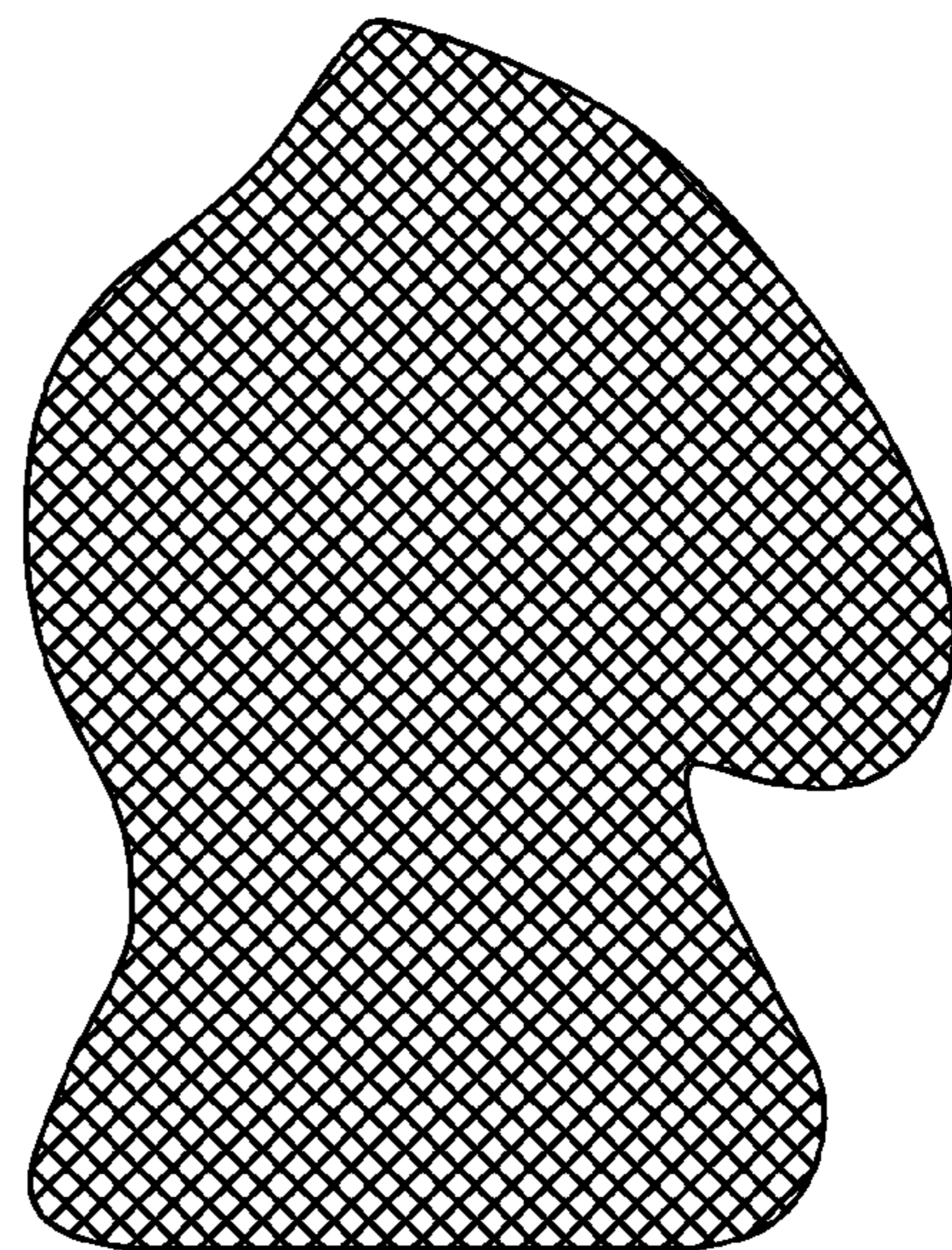

FIG. 25

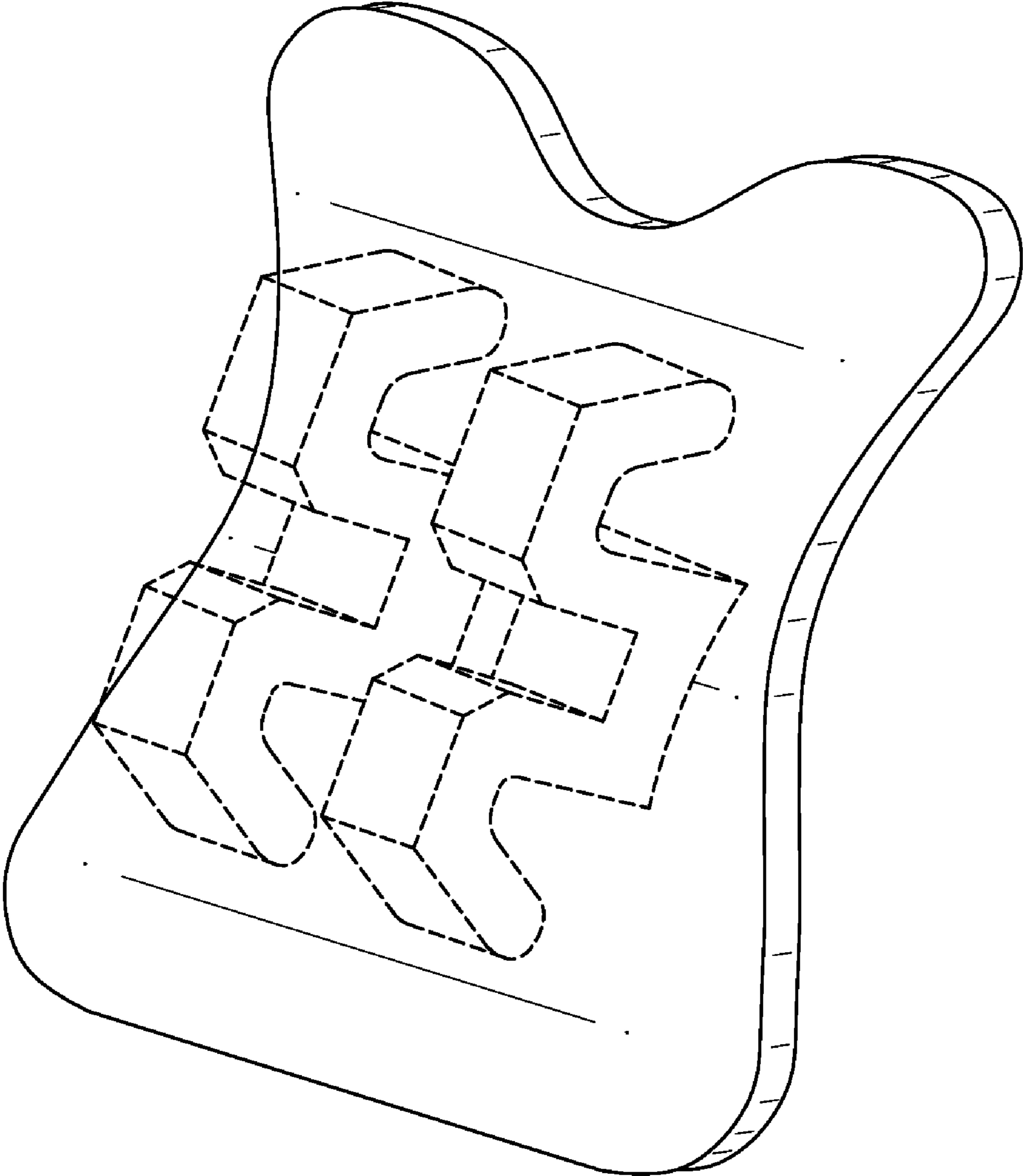

FIG.26

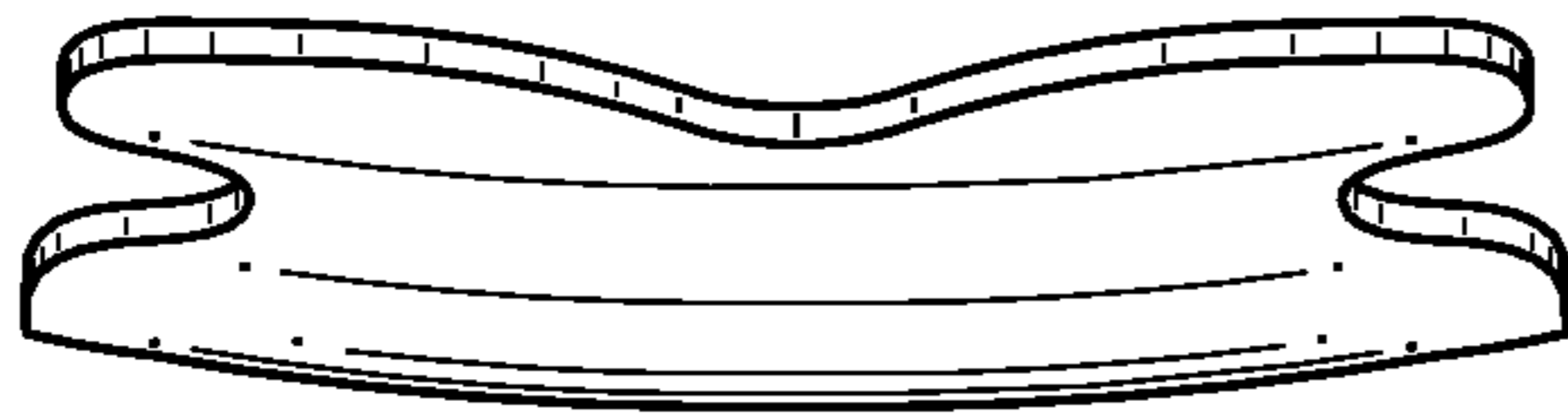

FIG.27

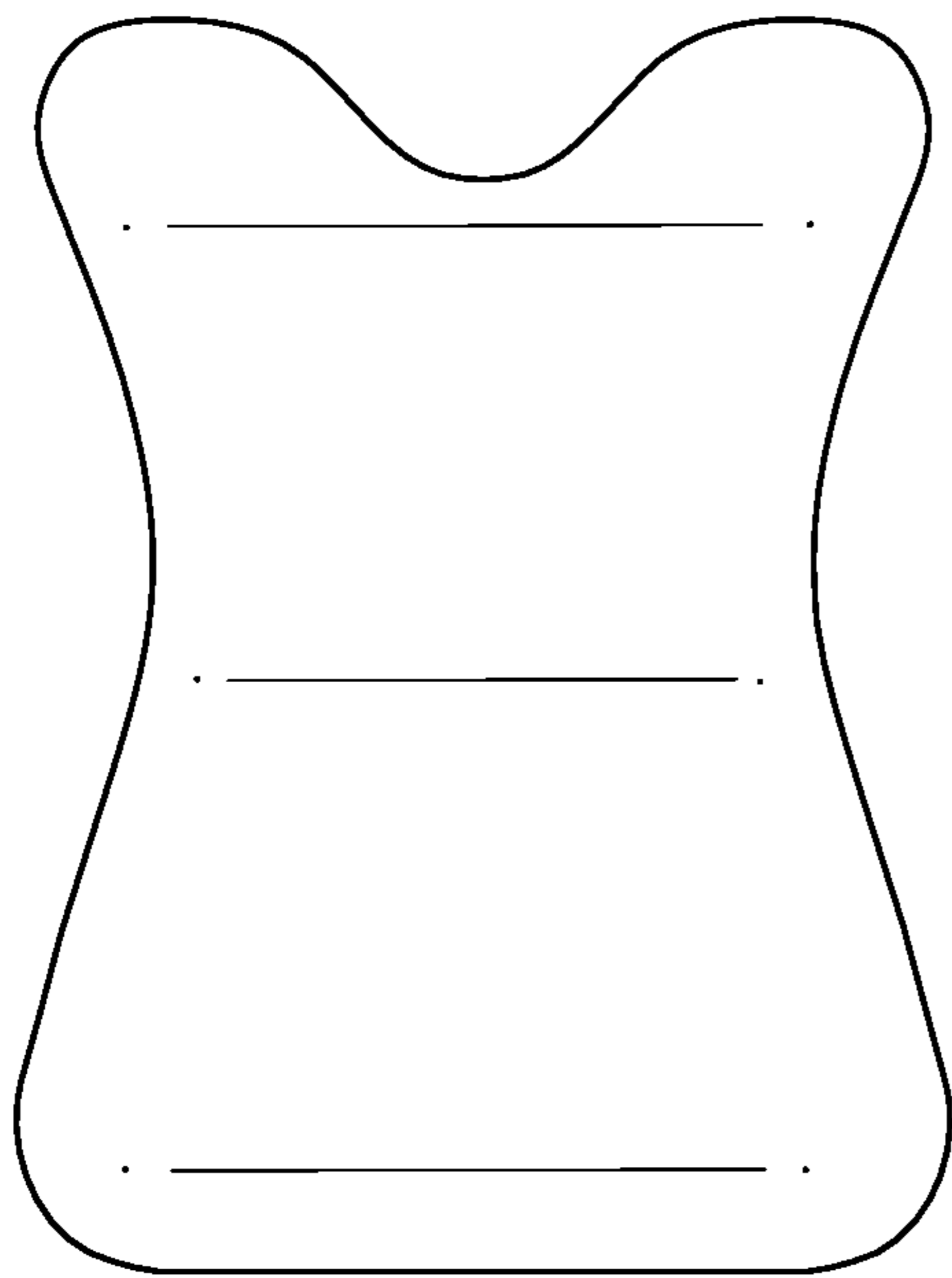

FIG.28



FIG.29

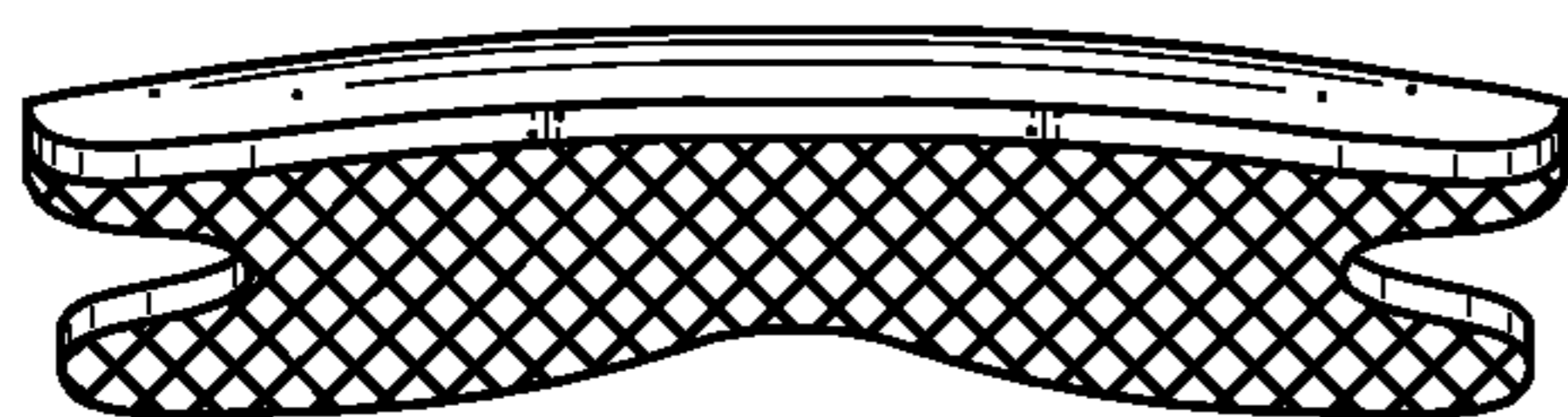

FIG.30

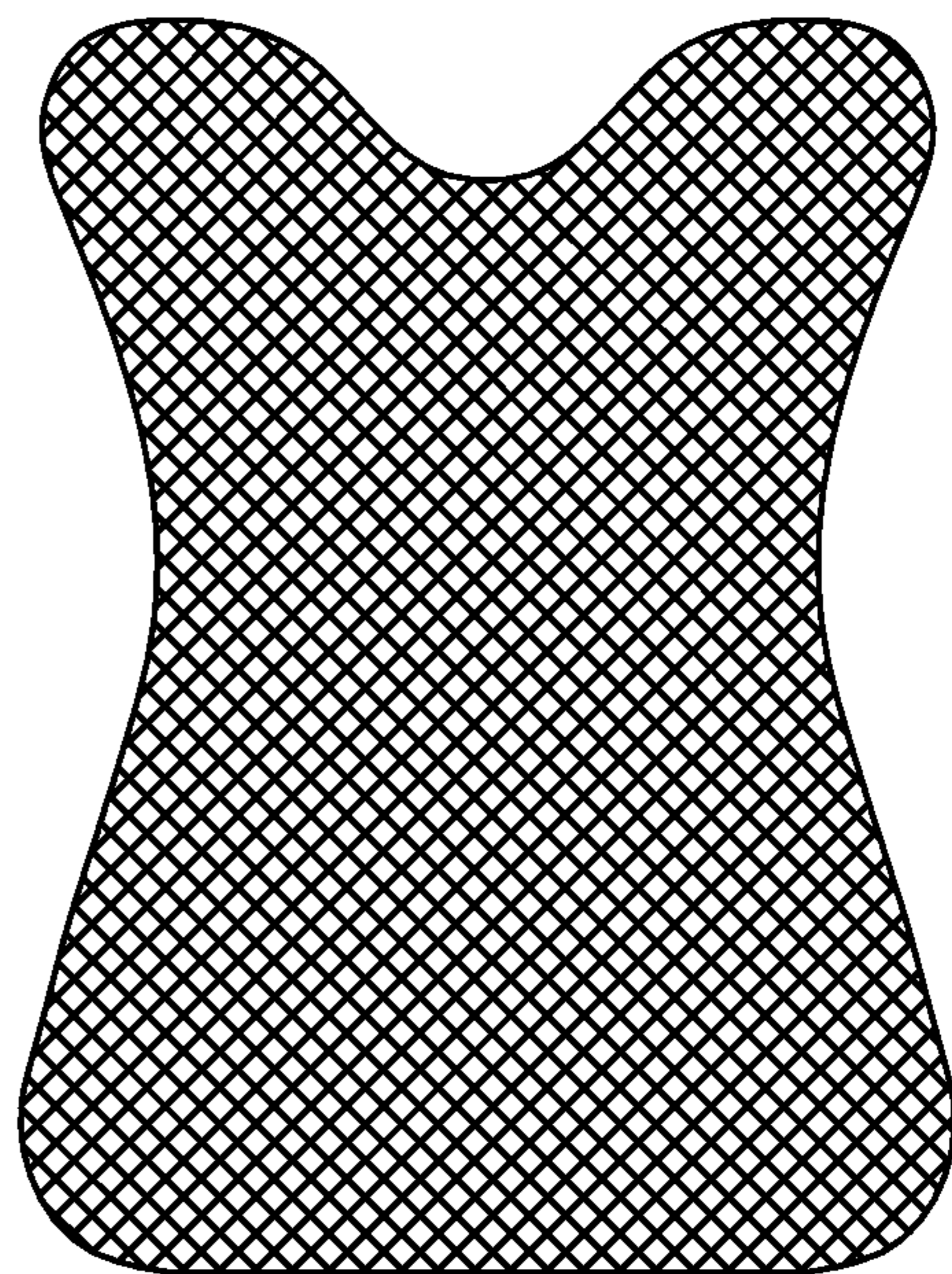

FIG.31

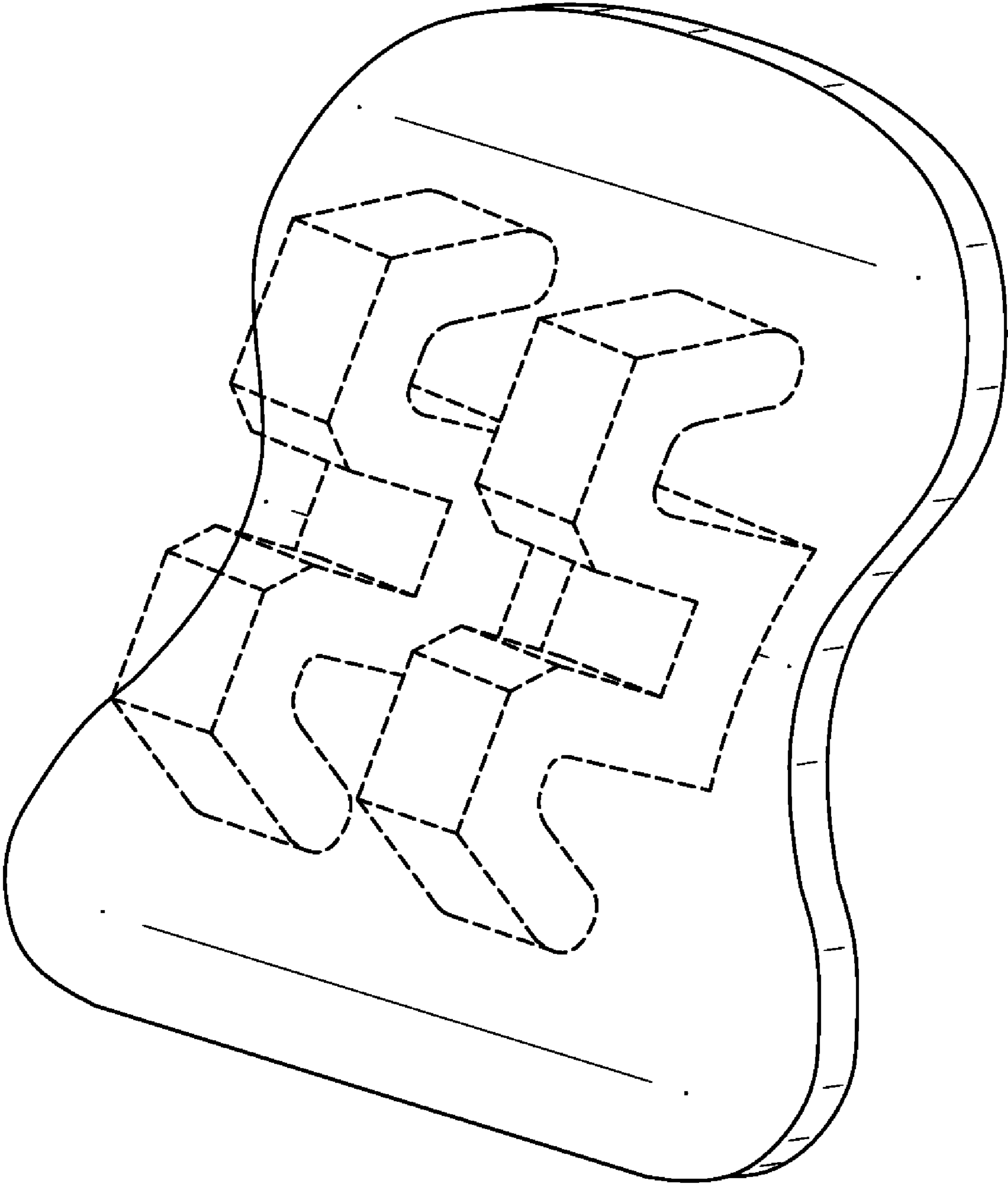

FIG.32

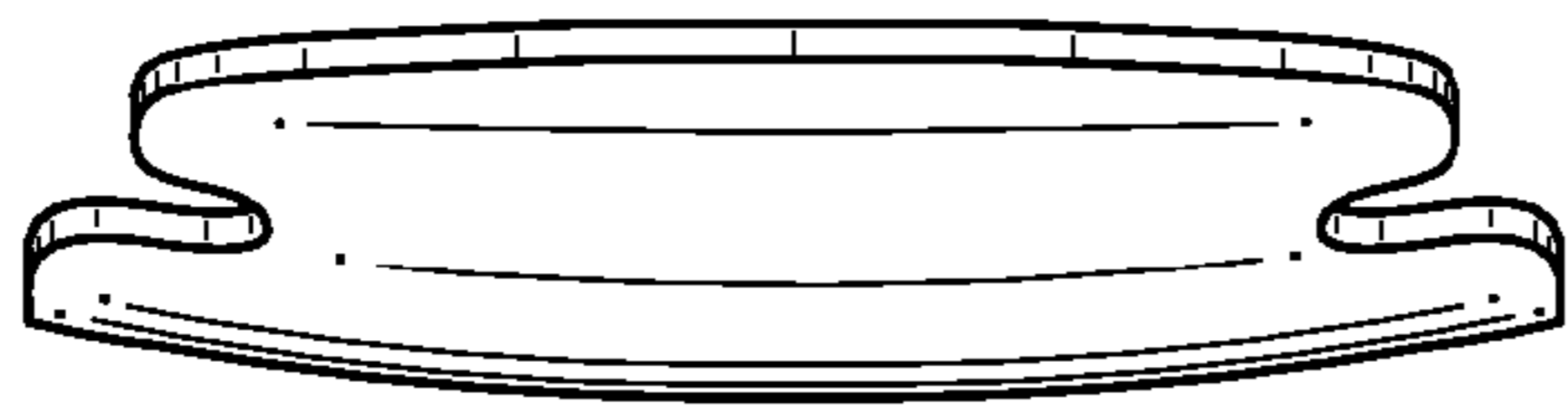

FIG.33

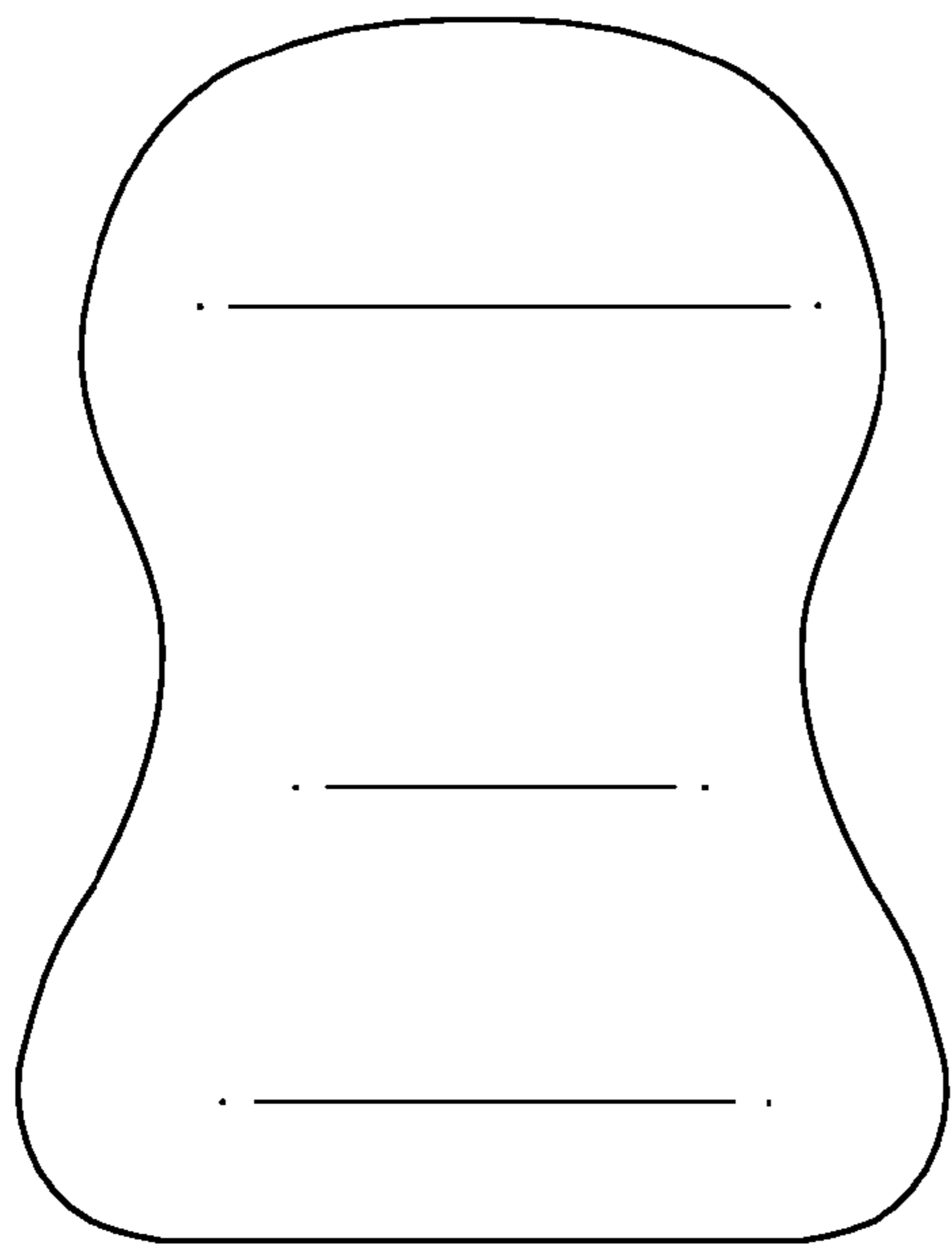

FIG.34



FIG.35

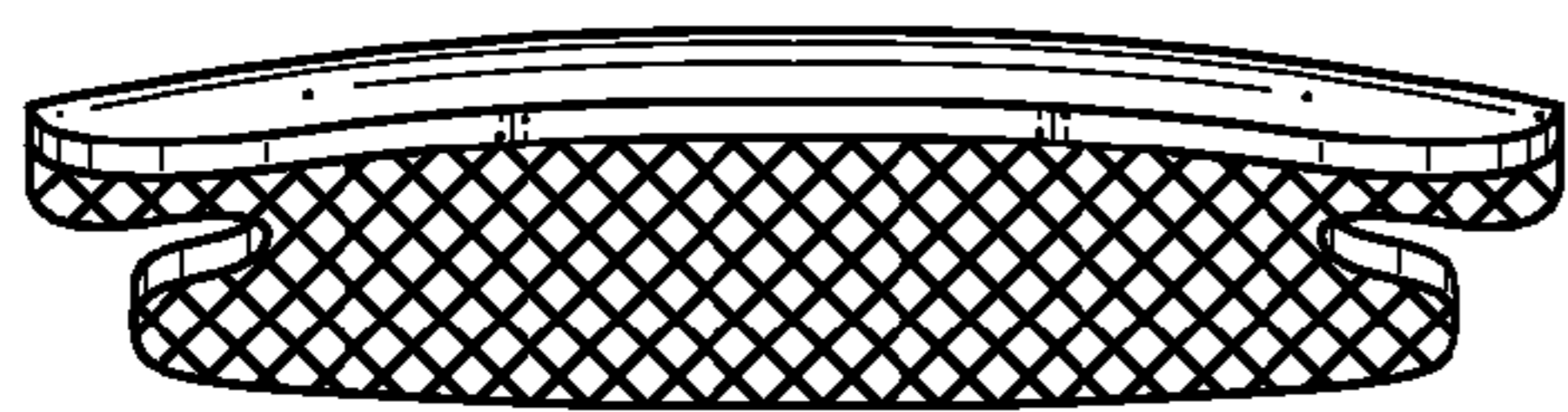

FIG.36

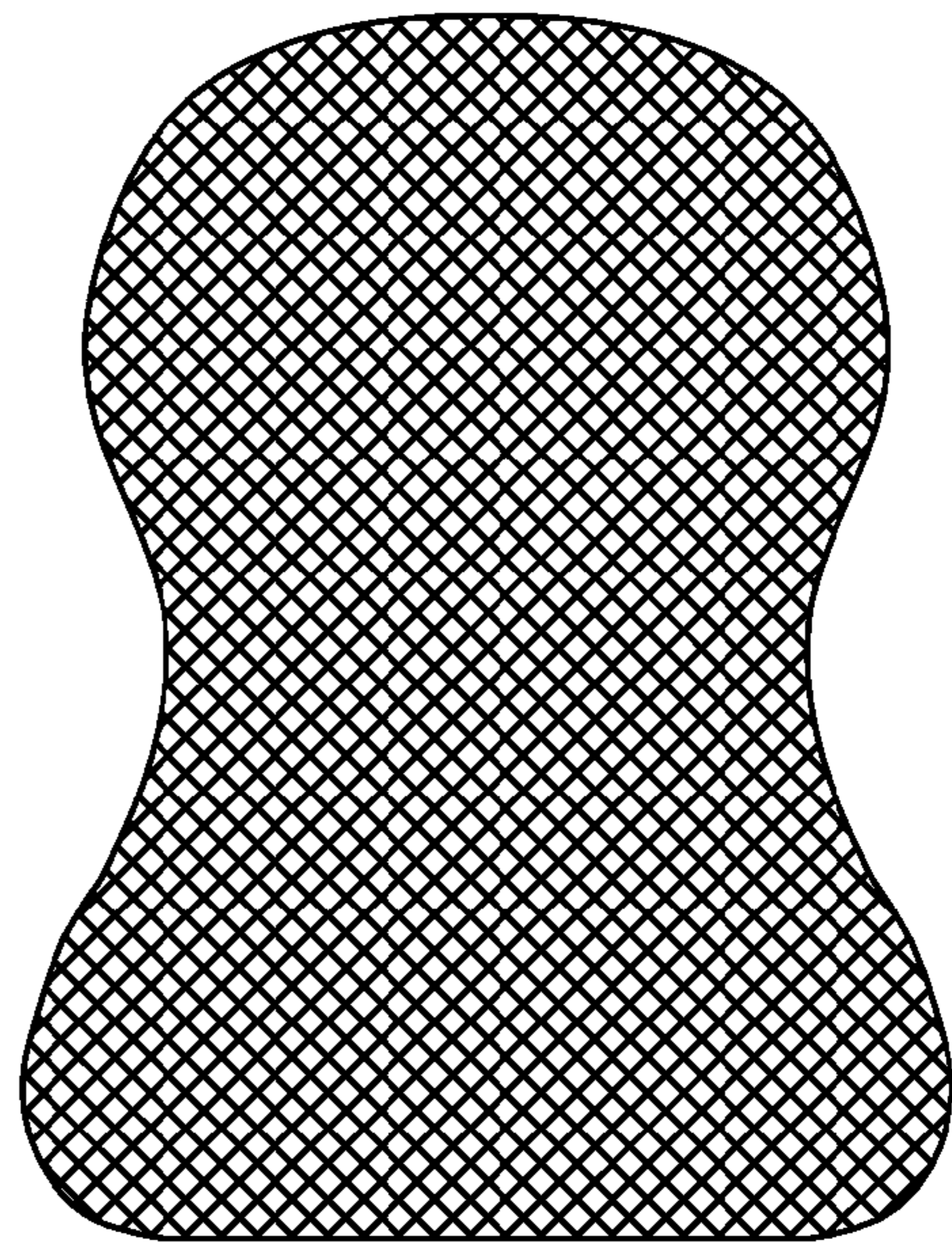

FIG.37

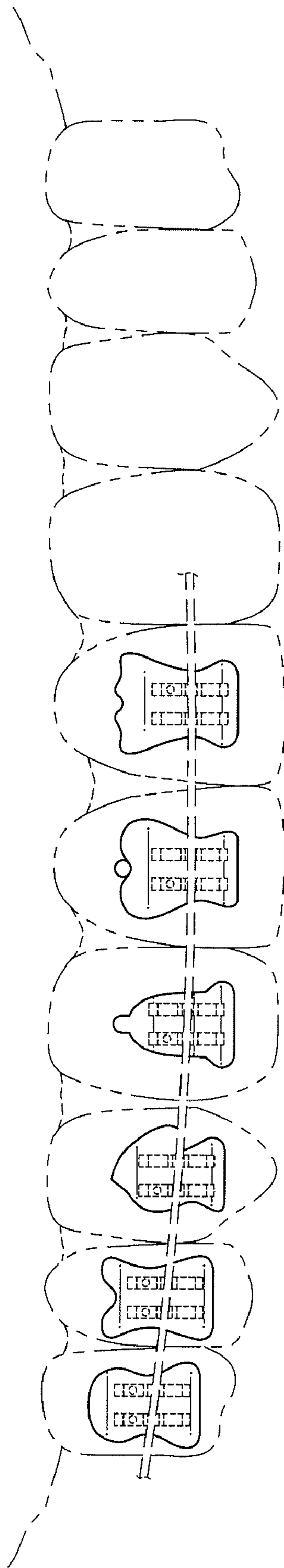

FIG. 38