



US00D606578S

(12) **United States Design Patent**  
**Markovitz et al.**

(10) **Patent No.:** **US D606,578 S**  
(45) **Date of Patent:** **\*\* Dec. 22, 2009**

(54) **EYEGLASSES**

(76) Inventors: **Aaron Markovitz**, 2361 Mason Ave.,  
Suite 100, Daytona Beach, FL (US)  
32117; **Artiss Akarra**, 2361 Mason  
Ave., Suite 100, Daytona Beach, FL (US)  
32117

(\*\*) Term: **14 Years**

(21) Appl. No.: **29/312,420**

(22) Filed: **Oct. 17, 2008**

(51) **LOC (9) Cl.** ..... **16-06**

(52) **U.S. Cl.** ..... **D16/320; D16/326**

(58) **Field of Classification Search** ..... D16/101,  
D16/300-342; D29/109-110; D24/110.2;  
351/41, 44, 51-52, 62, 158, 92, 103-123,  
351/140, 153, 45-46; 2/426-432, 447-449,  
2/441, 434-437, 13, 15; D21/483, 659-661

See application file for complete search history.

(56) **References Cited**

**U.S. PATENT DOCUMENTS**

2,403,223 A	7/1946	Kaesz
D146,004 S	12/1946	Jacobson
D146,602 S	4/1947	Jaffe
D149,312 S	4/1948	Schwartz
D151,222 S	10/1948	Ditto
2,482,195 A	9/1949	Martin
D155,580 S	10/1949	Coen
D170,745 S	11/1953	Carmichael
D173,868 S	1/1955	Belgard
D185,987 S	8/1959	Marfuggi
D192,884 S	5/1962	Petitto
3,052,160 A	9/1962	Ratti
D202,658 S	10/1965	Petitto
D204,812 S	5/1966	Schindler
D207,028 S	2/1967	Griss
D209,861 S	1/1968	Demmel
D210,697 S	4/1968	Ramp
D210,698 S	4/1968	Simon
D213,595 S	3/1969	Simon
D216,563 S	2/1970	Ramp

D218,128 S	*	7/1970	Bloch	.....	D16/320
D218,953 S		10/1970	Maiese		
D220,289 S		3/1971	Mitchell		
D220,291 S		3/1971	Leominster		
D227,405 S		6/1973	Shindler		
D232,380 S		8/1974	Johnsen		
D243,084 S		1/1977	Johnsen		
4,222,640 A		9/1980	Bononi		
D263,058 S		2/1982	Johnsen		
D285,020 S		8/1986	Schmidthaler		
D290,465 S		6/1987	Levoy		
D300,226 S		3/1989	Ramp		
D321,523 S		11/1991	Cherian		
5,343,259 A		8/1994	Nakanishi		
D369,375 S		4/1996	Jannard et al.		
5,541,674 A		7/1996	Jannard et al.		
D372,929 S		8/1996	Conway		
D376,810 S		12/1996	Ohie		
5,608,469 A		3/1997	Bollè		
D380,487 S		7/1997	Nevitt		
D382,291 S		8/1997	Wilson		

(Continued)

**OTHER PUBLICATIONS**

Fathom, Glass Mirror Lens. Costa Del Mar. Downloaded Dec. 7,  
2006 at <http://www.eyeglasses.com/product/1091472073-1091472073>.

*Primary Examiner*—Raphael Barkai  
(74) *Attorney, Agent, or Firm*—Malloy & Malloy, P.A.

(57) **CLAIM**

The ornamental design for eyeglasses, as shown and described.

**DESCRIPTION**

FIG. 1 is a top view illustrating my design for eyeglasses;  
FIG. 2 is a perspective view thereof;  
FIG. 3 is a side view thereof;  
FIG. 4 is a front view thereof;  
FIG. 5 is a bottom view thereof; and,  
FIG. 6 is a rear view thereof.

**1 Claim, 6 Drawing Sheets**

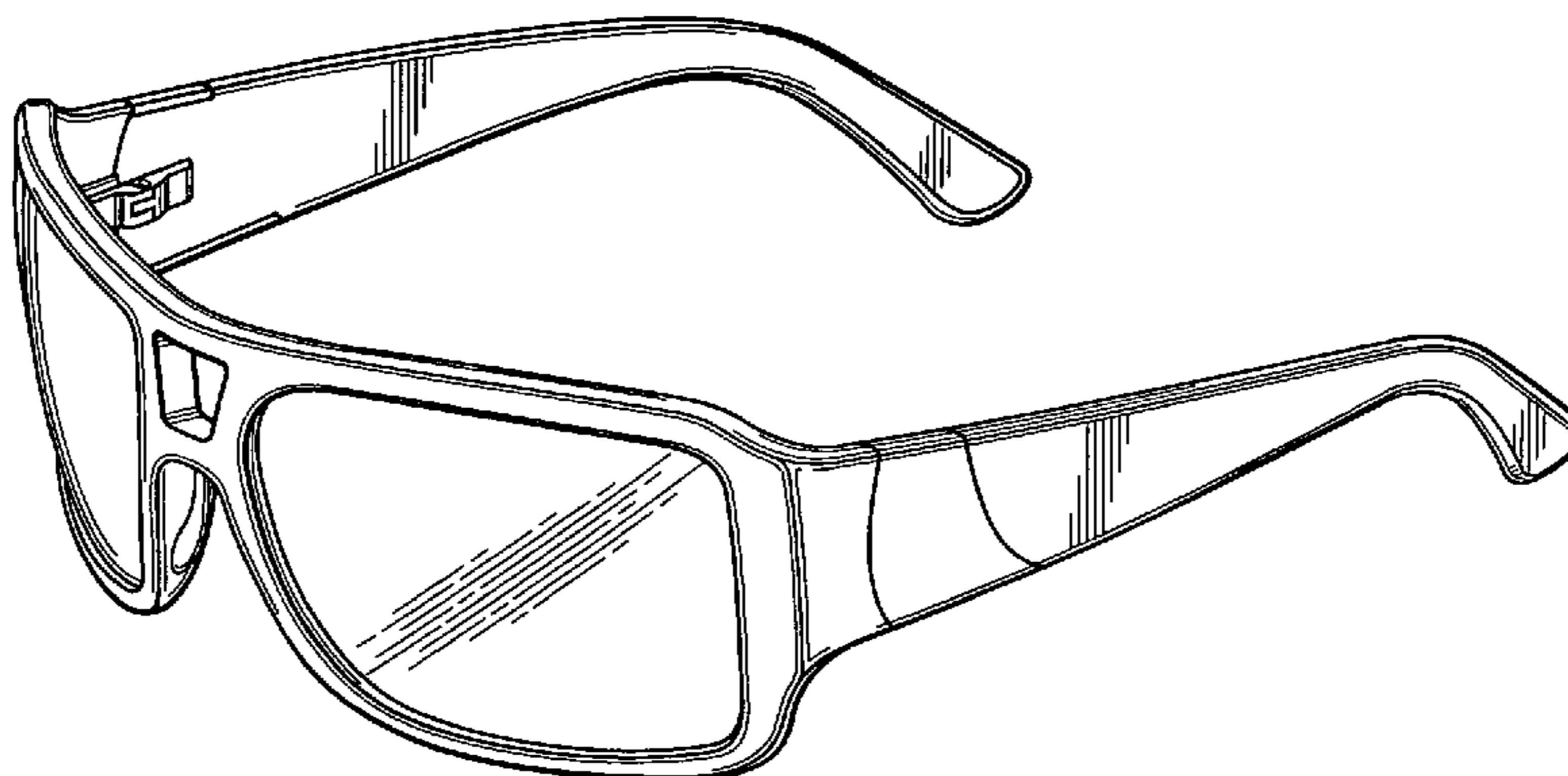

U.S. PATENT DOCUMENTS

D382,892 S	8/1997	Murai	D534,573 S	1/2007	Mage
D383,478 S	9/1997	Wilson	D534,942 S	1/2007	Lynch
D385,291 S	10/1997	Jannard et al.	D535,316 S	1/2007	Teng
D391,596 S	3/1998	Simioni	D535,317 S	1/2007	Wolfe
D393,653 S	4/1998	Howard, IV	D536,028 S	1/2007	Paulson
D394,871 S	6/1998	Simioni	D537,861 S	3/2007	Teng
5,764,333 A	6/1998	Somsel	D537,863 S	3/2007	Markovitz
D397,350 S	8/1998	Jannard et al.	D538,326 S	3/2007	Guo
D397,712 S	9/1998	Simioni	D539,834 S	4/2007	Hester
D398,022 S	9/1998	Jannard et al.	D540,370 S	4/2007	Sheldon
D398,330 S	9/1998	Lin	D540,846 S	4/2007	Sheldon
D399,238 S	10/1998	Simioni	D541,839 S	5/2007	Sheldon
D401,610 S	11/1998	Flanagan	D542,330 S	5/2007	Elmore
D408,841 S	4/1999	Conway	D543,572 S	5/2007	Yee et al.
D410,022 S	5/1999	Conway	D544,018 S	6/2007	Huang
D414,796 S	10/1999	Arnette	D544,521 S	6/2007	Lee
D420,035 S	2/2000	Hartman	D545,348 S *	6/2007	Chen et al. .... D16/326
D423,034 S	4/2000	Arnette	D545,872 S	7/2007	Yee et al.
D423,551 S	4/2000	Lamy	D545,873 S	7/2007	Sheldon
D424,094 S	5/2000	Conway	D546,867 S	7/2007	Teng
D424,598 S	5/2000	Simioni	D547,794 S	7/2007	Jannard et al.
D427,227 S	6/2000	Conway	D548,769 S	8/2007	Chen
D427,622 S	7/2000	Conway	D549,268 S	8/2007	Daems et al.
D429,754 S	8/2000	Markovitz et al.	D549,746 S	8/2007	Popov
D434,789 S	12/2000	Lane	D549,764 S	8/2007	Teng
6,168,271 B1	1/2001	Houston et al.	D550,272 S	9/2007	Markovitz
D441,002 S	4/2001	Stark et al.	D550,755 S	9/2007	Fuchs
6,233,342 B1	5/2001	Fernandez	D550,757 S	9/2007	Li et al.
D445,821 S	7/2001	Agnoli	D552,155 S	10/2007	Markovitz
6,253,388 B1	7/2001	Lando	D552,665 S	10/2007	Mage
6,264,327 B1	7/2001	Copeland	D553,177 S	10/2007	Chen et al.
D449,640 S	10/2001	Grundy	D553,663 S	10/2007	Moody
D449,641 S	10/2001	Arnette	D554,687 S *	11/2007	Arnette ..... D16/320
D450,744 S	11/2001	Rhoades et al.	D554,689 S	11/2007	Jannard et al.
D451,120 S	11/2001	Venezia	D555,705 S	11/2007	Chuang
D453,024 S	1/2002	Bonnemere	D556,245 S	11/2007	Lane
6,334,680 B1	1/2002	Larson	D556,246 S	11/2007	Yee
D456,038 S	4/2002	Arnette	D557,324 S	12/2007	Moody
D456,441 S	4/2002	Jannard et al.	D557,730 S	12/2007	Mage et al.
D464,669 S	10/2002	Thixton et al.	D557,731 S	12/2007	Mage et al.
D469,459 S	1/2003	Moritz	D558,816 S	1/2008	Yee
D470,167 S	2/2003	Jannard et al.	D559,301 S	1/2008	Elmore
D470,883 S	2/2003	Teng	D561,809 S	2/2008	Yee et al.
D472,915 S	4/2003	Rohrbach et al.	D561,810 S	2/2008	Fox et al.
D475,733 S	6/2003	Lee	D561,812 S	2/2008	Fox et al.
6,604,824 B2	8/2003	Larson	D561,813 S	2/2008	Baden et al.
D481,751 S	11/2003	Stables	D561,814 S	2/2008	Thixton et al.
D483,393 S	12/2003	Chen	D563,455 S	3/2008	Markovitz
D487,477 S	3/2004	Lane	D565,087 S	3/2008	Yee et al.
D488,499 S	4/2004	Mage	D568,921 S	5/2008	Anderl
6,715,873 B2	4/2004	Nahmias	D568,924 S	5/2008	Markovitz
6,783,235 B1	8/2004	Lin	D570,900 S	6/2008	Markovitz
D496,064 S	9/2004	Mangum	D572,294 S	7/2008	Markovitz
D500,781 S	1/2005	Mage	D572,748 S	7/2008	Markovitz
D501,218 S	1/2005	Teng	D575,813 S	8/2008	Li
D513,518 S	1/2006	Stables	D580,475 S	11/2008	Markovitz et al.
D515,617 S	2/2006	Stables	D581,449 S	11/2008	Yee
D515,618 S	2/2006	Stables	D581,450 S	11/2008	Moritz
D518,502 S	4/2006	Teng	D583,853 S	12/2008	Markovitz
D519,146 S	4/2006	Yasuhara	D585,928 S	2/2009	Markovitz
D519,148 S	4/2006	Wu	D588,626 S	3/2009	Markovitz
7,036,927 B2	5/2006	Kopfer	D589,079 S	3/2009	Markovitz et al.
D525,278 S	7/2006	Krefman	D594,052 S *	6/2009	Yang ..... D16/326
D532,438 S	11/2006	Yang	2006/0238698 A1	10/2006	Sheldon
D533,892 S	12/2006	Moody et al.	2006/0268218 A1	11/2006	Medana
D534,569 S	1/2007	Teng			

\* cited by examiner

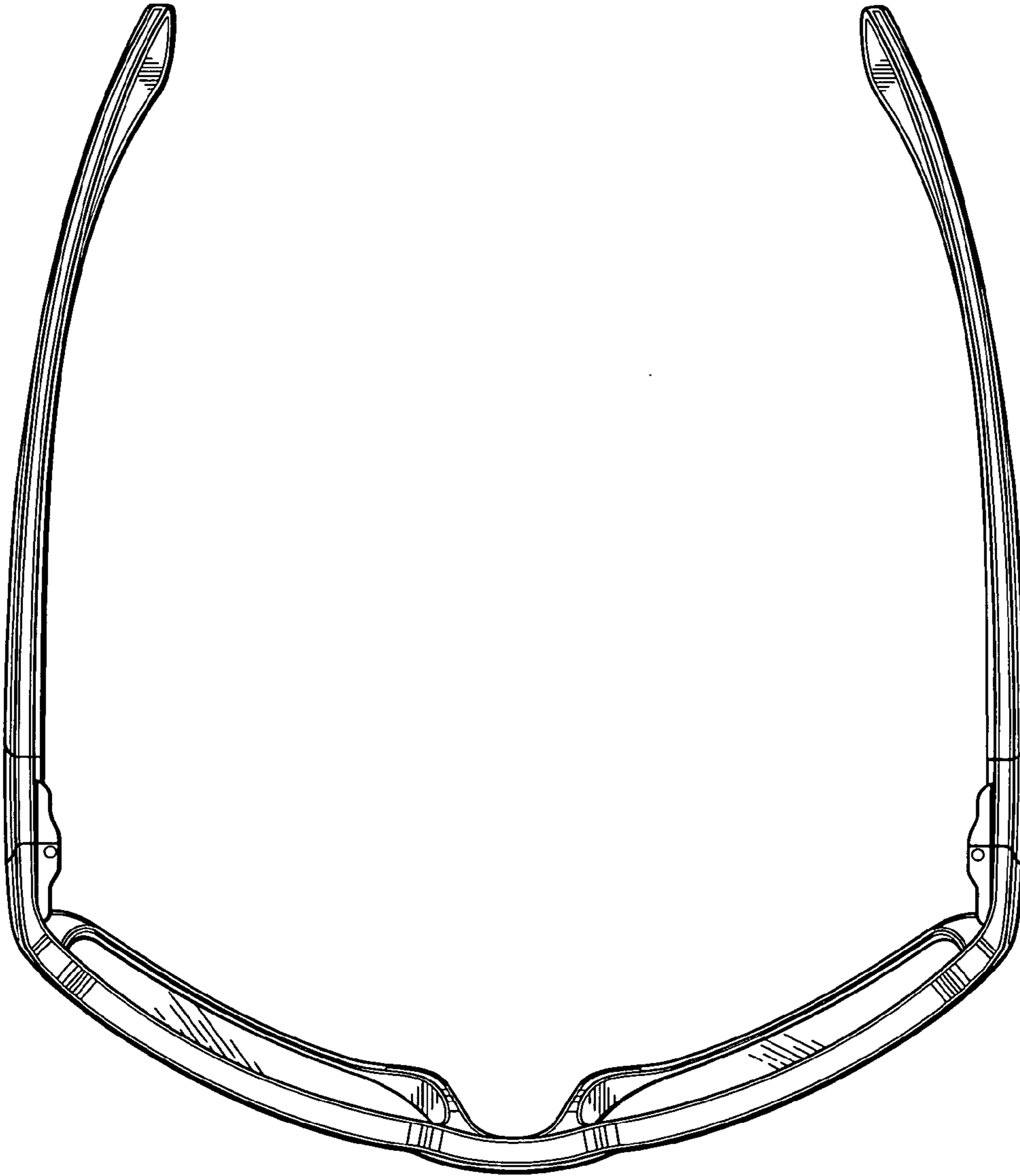

FIG. 1

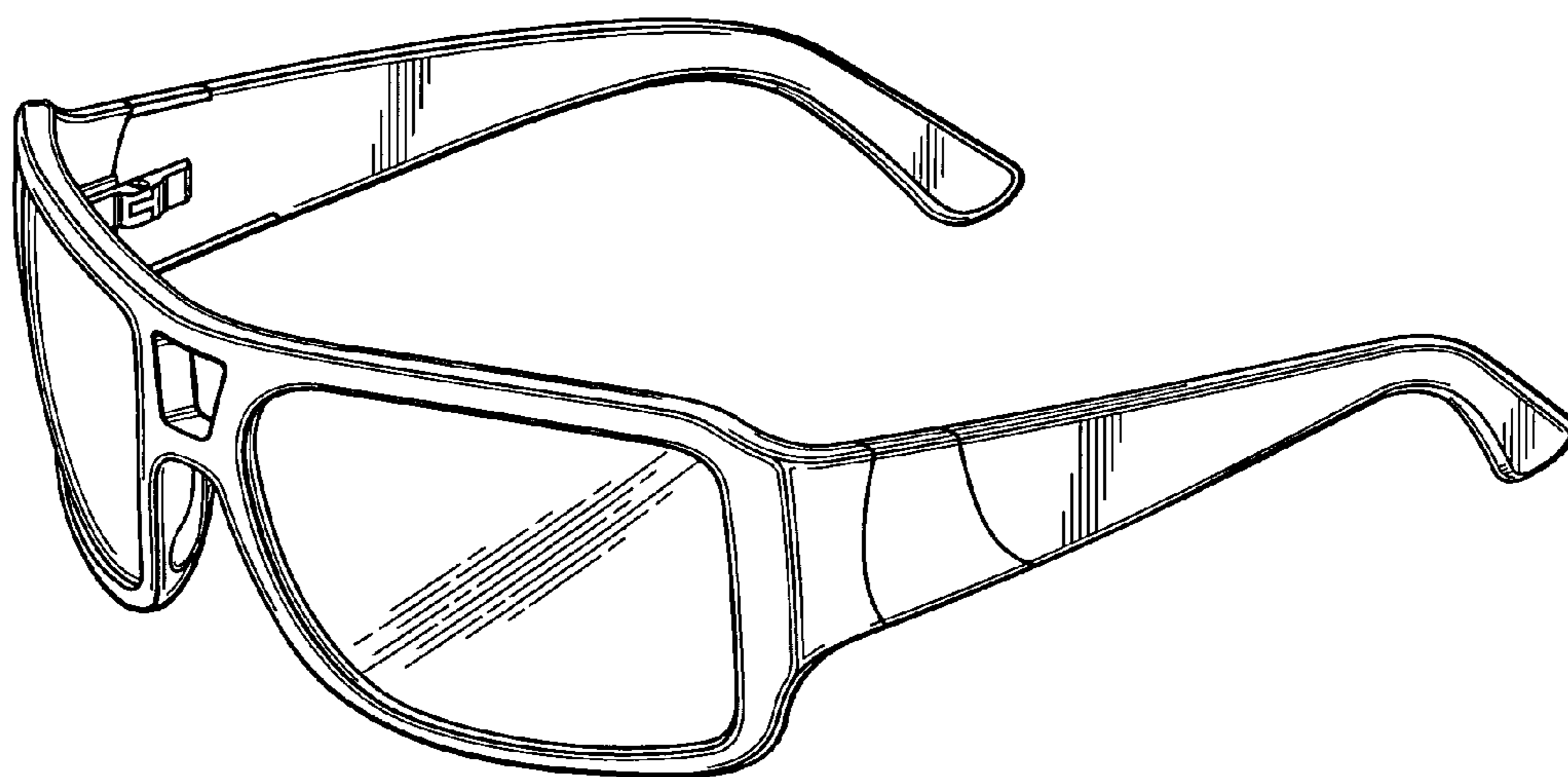

FIG. 2

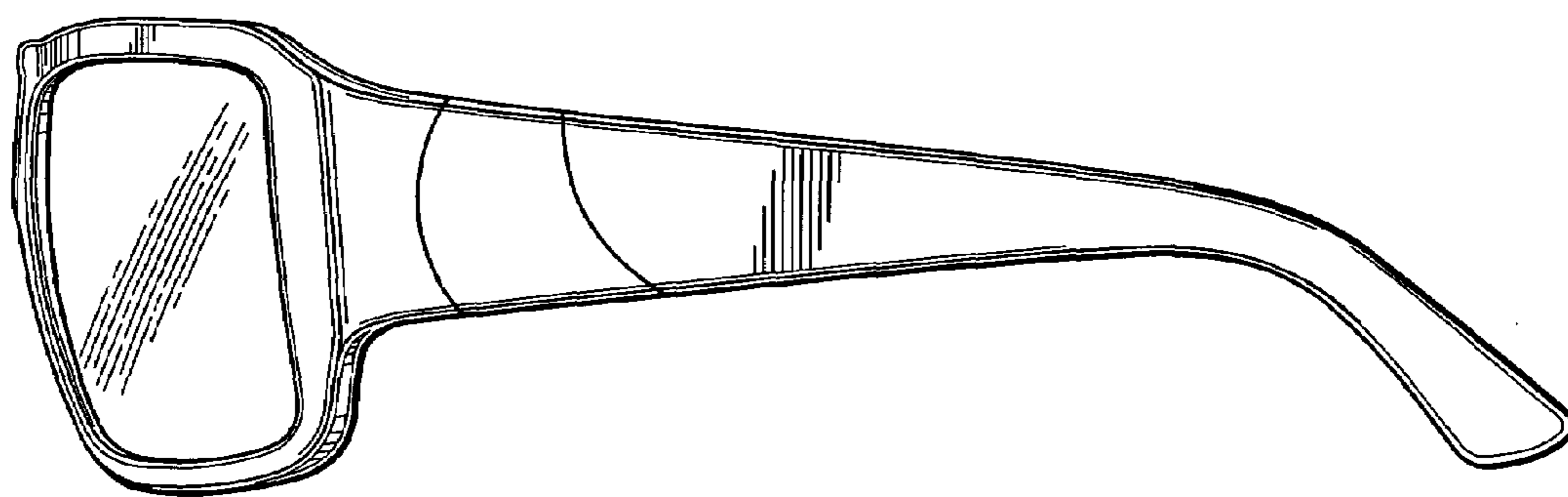

FIG. 3

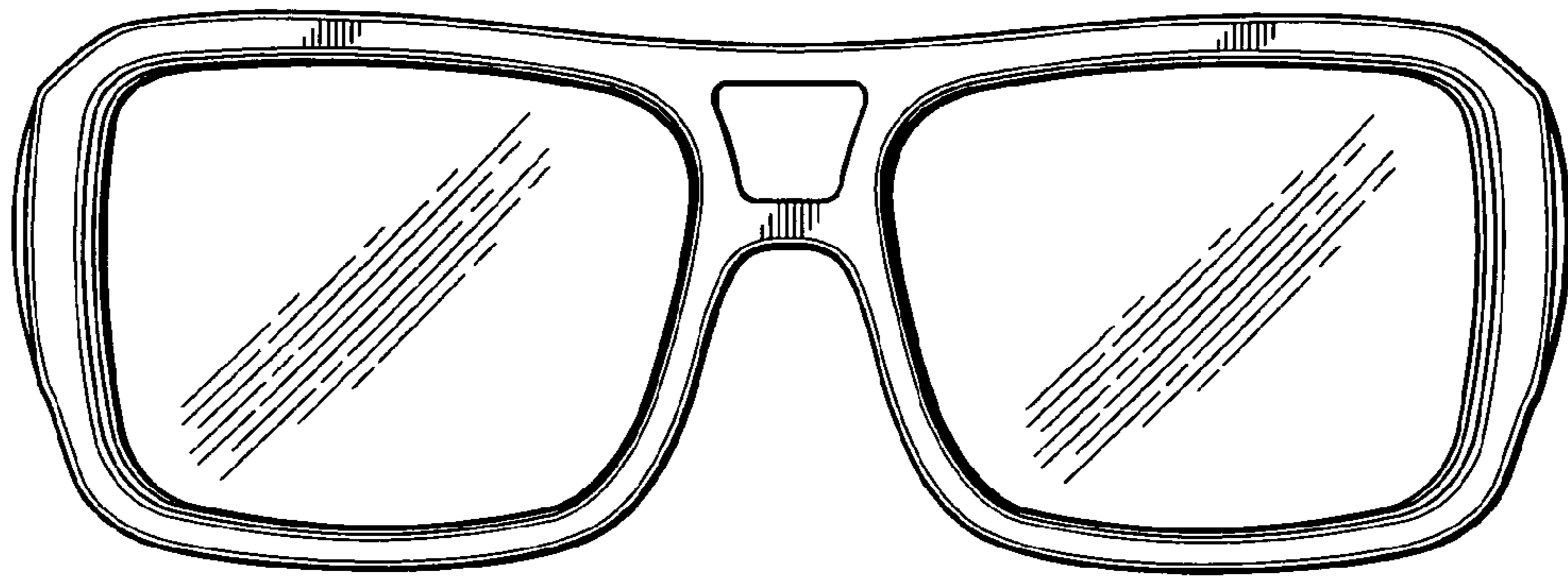

FIG. 4

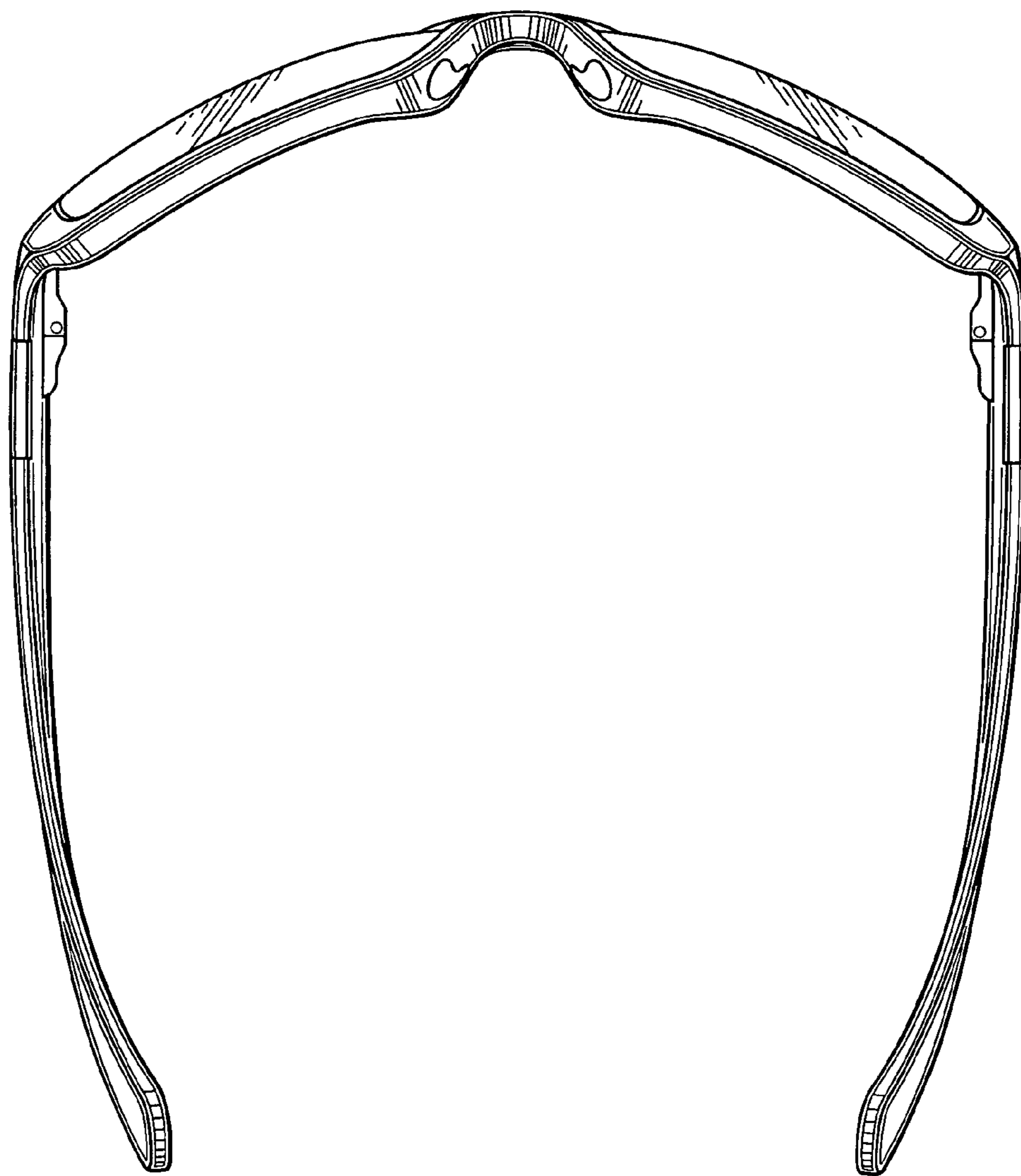

FIG. 5

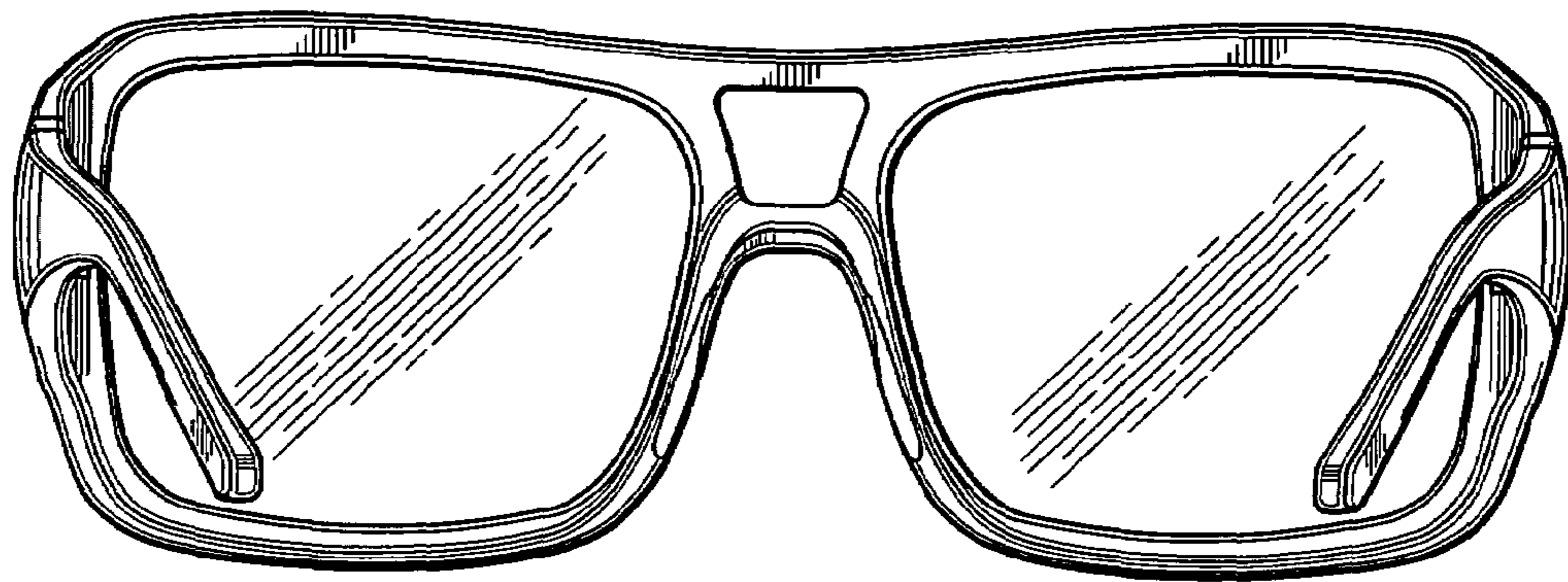

FIG. 6