



US00D606470S

(12) **United States Design Patent**
Mattin et al.

(10) **Patent No.:** **US D606,470 S**
(45) **Date of Patent:** **** Dec. 22, 2009**

(54) **VEHICLE MIRROR**

(75) Inventors: **Stephen Mattin**, Göteborg (SE); **Fedde Talsma**, Göteborg (SE); **Douglas Hall Frasher**, Newbury Park, CA (US)

(73) Assignee: **Ford Global Technologies, LLC**, Dearborn, MI (US)

(**) Term: **14 Years**

(21) Appl. No.: **29/328,066**

(22) Filed: **Nov. 18, 2008**

(51) **LOC (9) Cl.** **12-16**

(52) **U.S. Cl.** **D12/187**

(58) **Field of Classification Search** D12/187-189,
D12/99; D6/300, 309; 359/838, 841, 842,
359/844, 868, 871, 872, 877, 604, 881, 514,
359/866; 248/475.1, 479-483

See application file for complete search history.

(56) **References Cited**

U.S. PATENT DOCUMENTS

D500,273 S *	12/2004	Otto et al.	D12/187
6,981,774 B2 *	1/2006	Dumont et al.	359/877
7,104,662 B2 *	9/2006	Kawanishi	359/871
D571,698 S *	6/2008	Imai et al.	D12/187
D577,639 S *	9/2008	Choi et al.	D12/187
D579,839 S *	11/2008	Gale et al.	D12/187

2008/0247068 A1 *	10/2008	Wakabayashi	359/871
2008/0253008 A1 *	10/2008	Tseng	359/876
2008/0291560 A1 *	11/2008	Mueller	359/872

* cited by examiner

Primary Examiner—Caron Veynar

Assistant Examiner—Katrina A Kile

(74) *Attorney, Agent, or Firm*—Damian Porcari

(57) **CLAIM**

An ornamental design for a vehicle mirror, shown and described.

DESCRIPTION

FIG. 1 is a top plan view of a vehicle mirror (the right being a mirror image of the left and is not illustrated);

FIG. 2 is a bottom plan view of the vehicle mirror;

FIG. 3 is front elevational view of the vehicle mirror;

FIG. 4 is a left side elevational view of the vehicle mirror;

FIG. 5 is a perspective view of the vehicle mirror;

FIG. 6 is another perspective view of the vehicle mirror;

FIG. 7 is a rear elevational view of the vehicle mirror; and,

FIG. 8 is a right side view of the vehicle mirror.

In the photographs, the broken line shows a boundary line and forms no part of the claimed design.

1 Claim, 8 Drawing Sheets

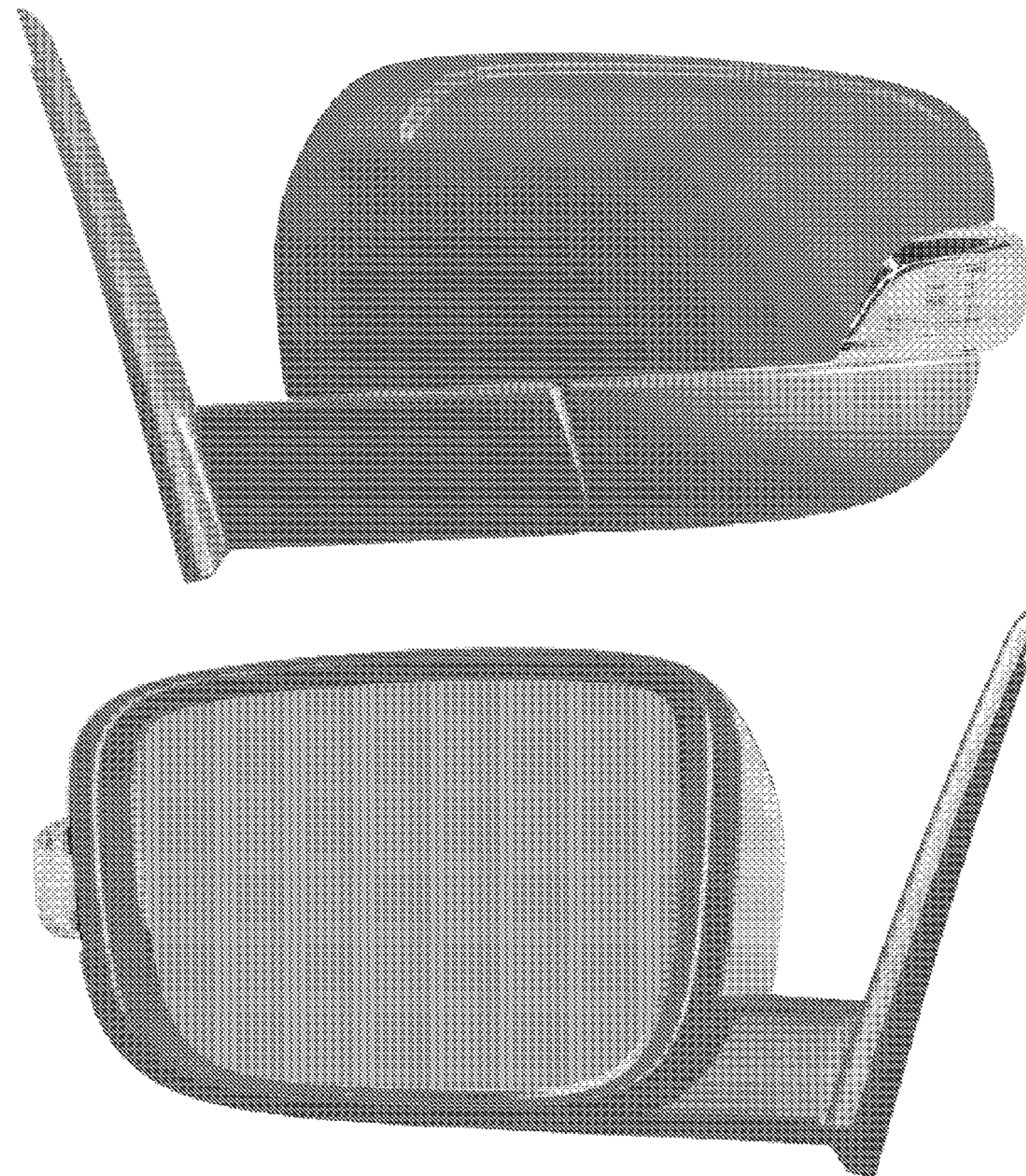

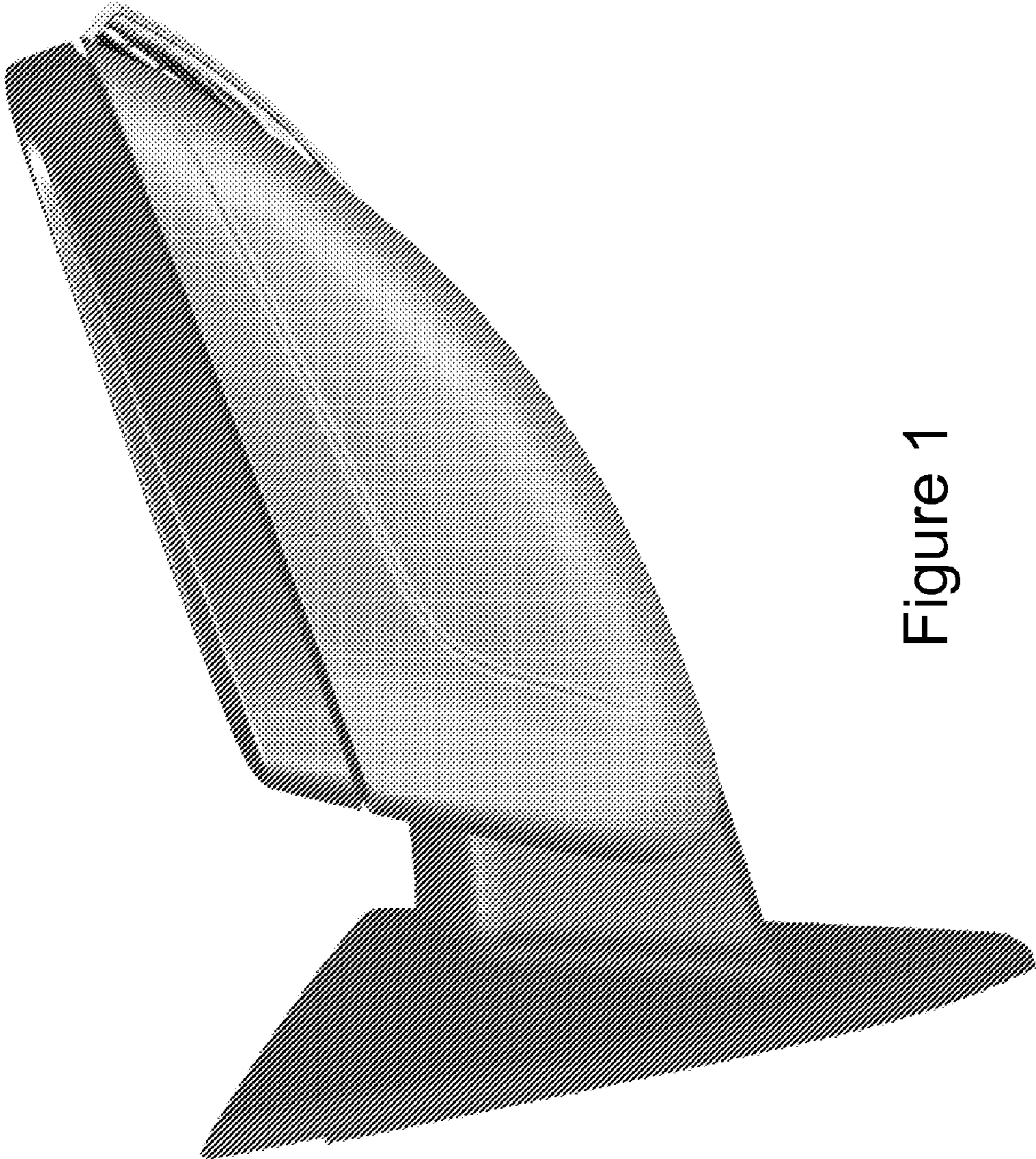

Figure 1

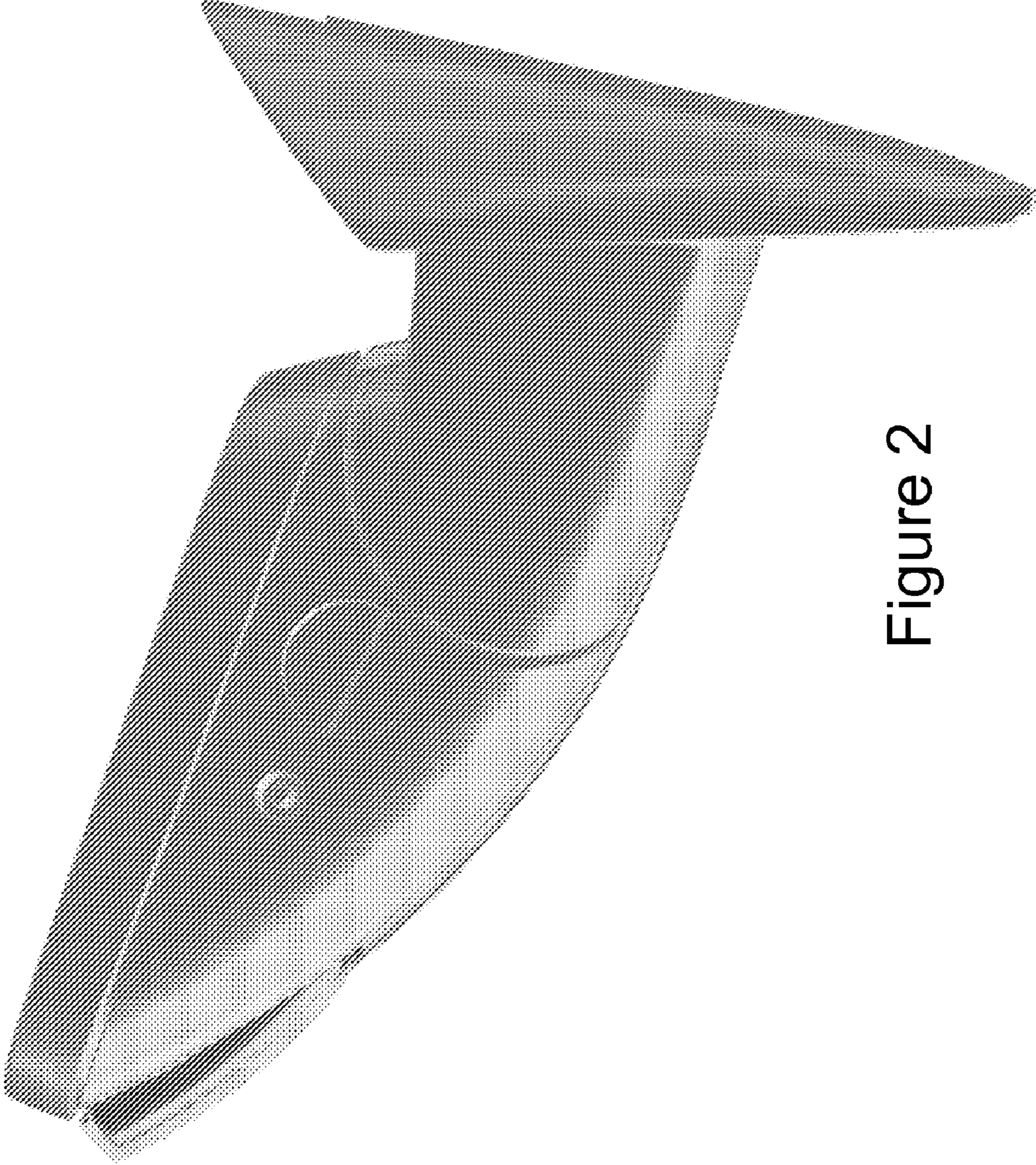

Figure 2

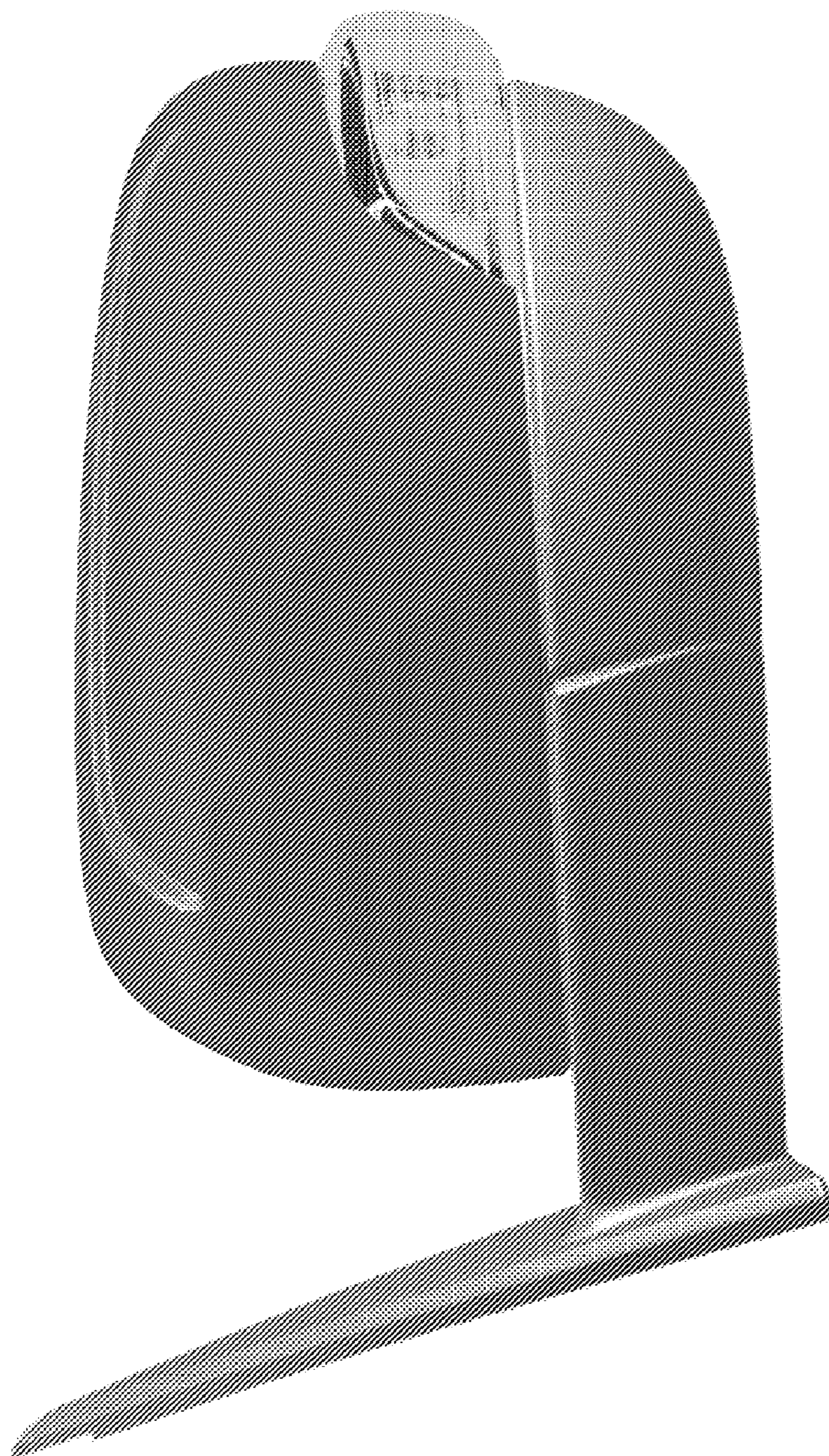

Figure 3



Figure 4

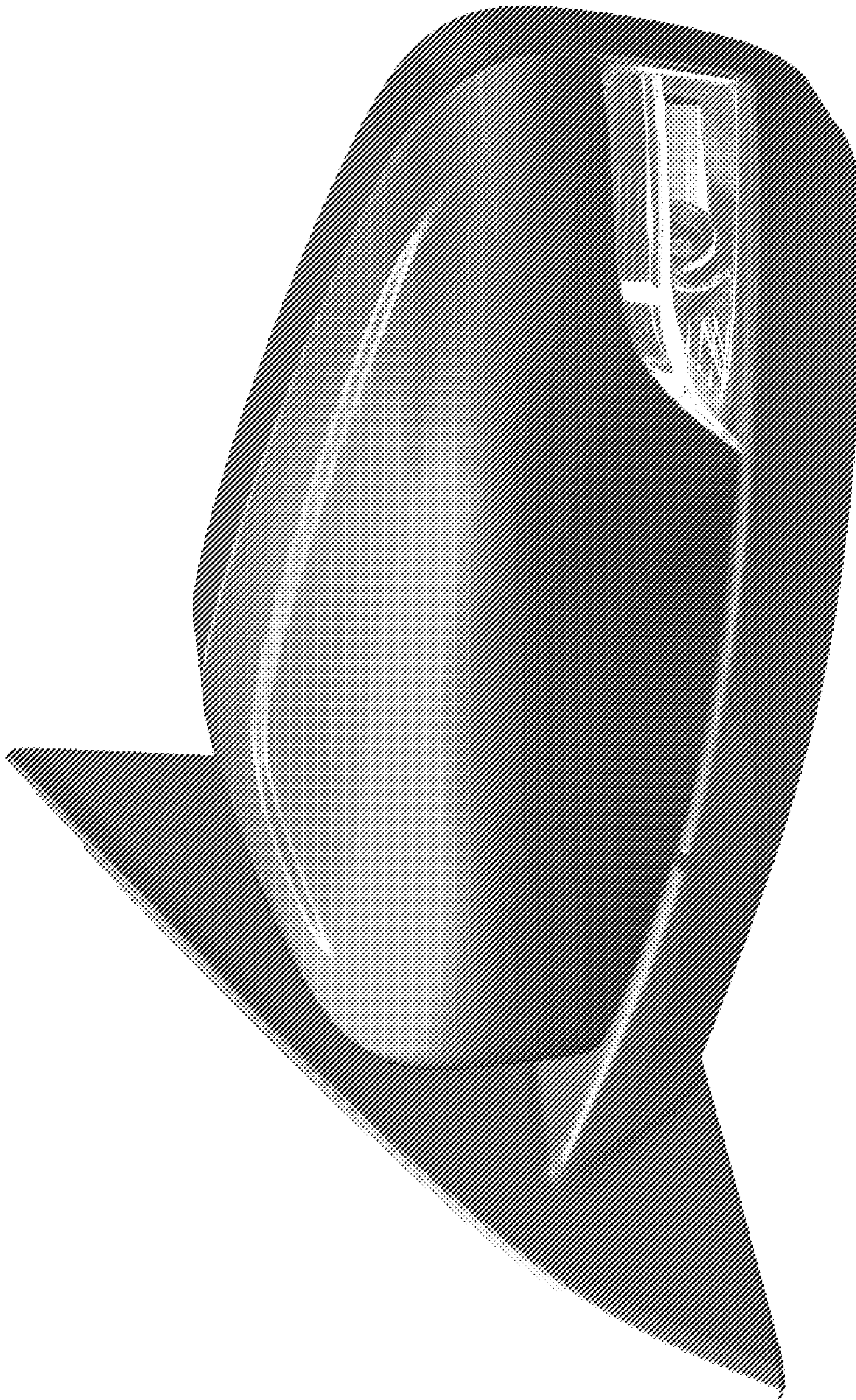

Figure 5

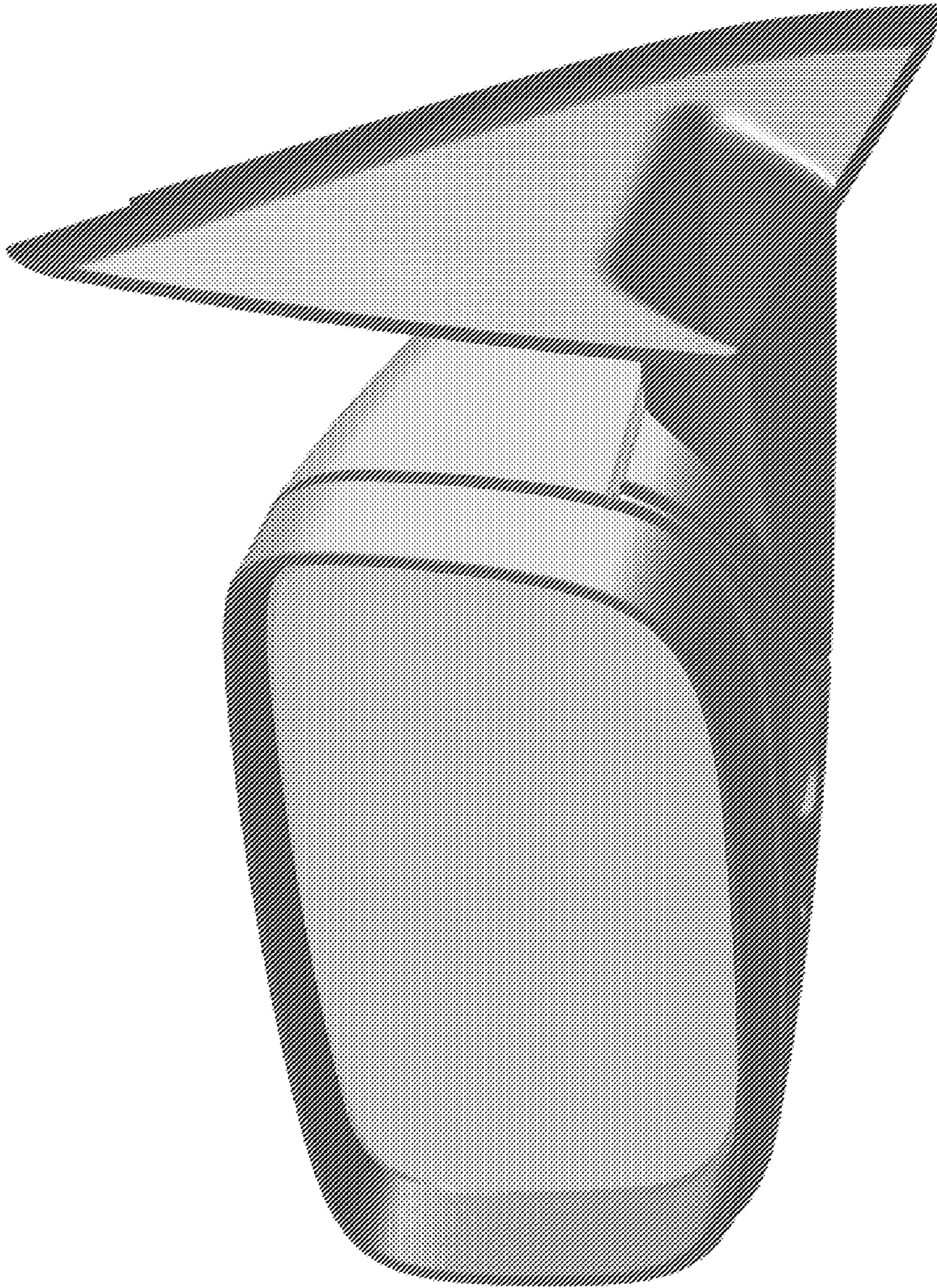

Figure 6

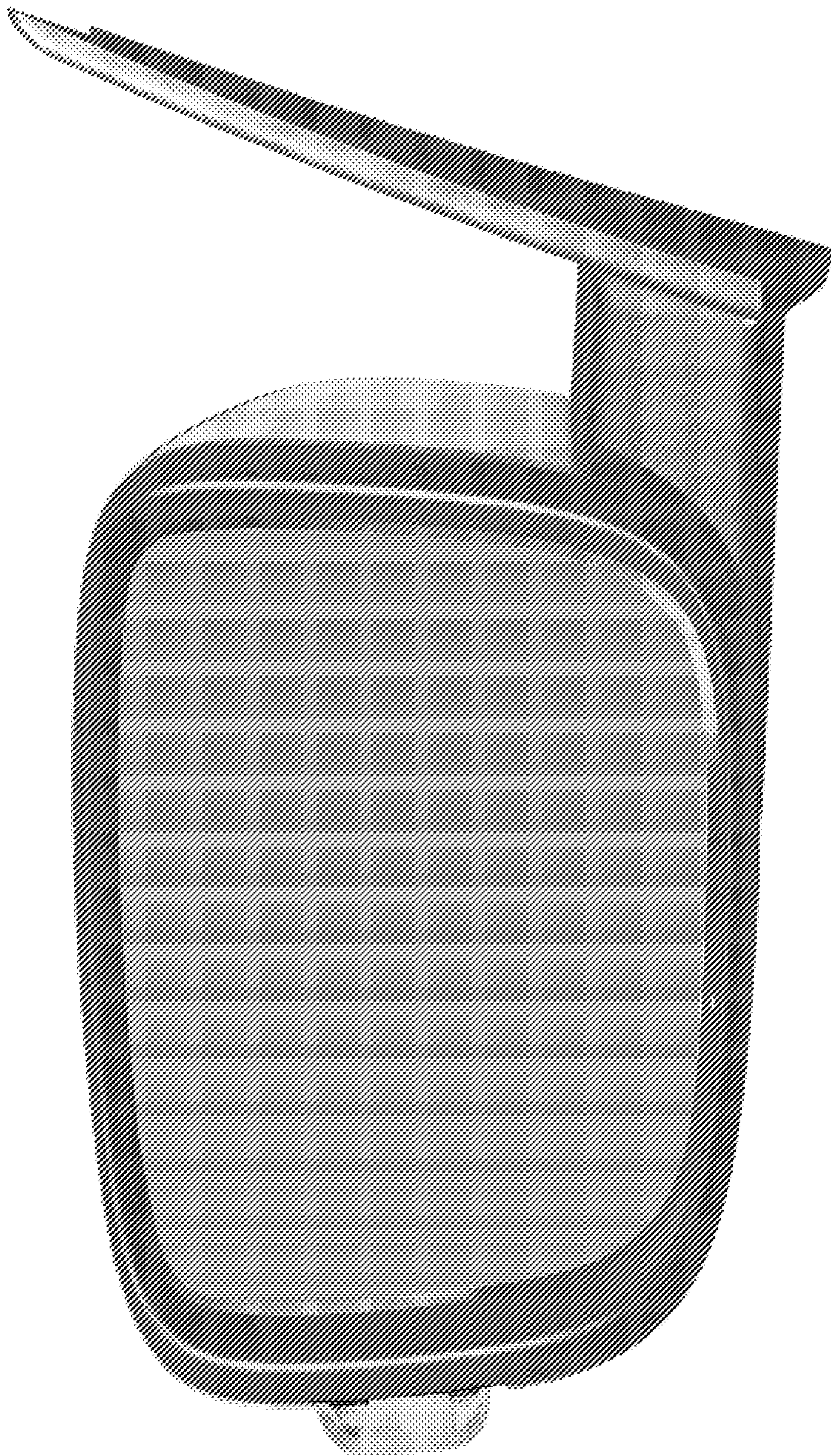

Figure 7

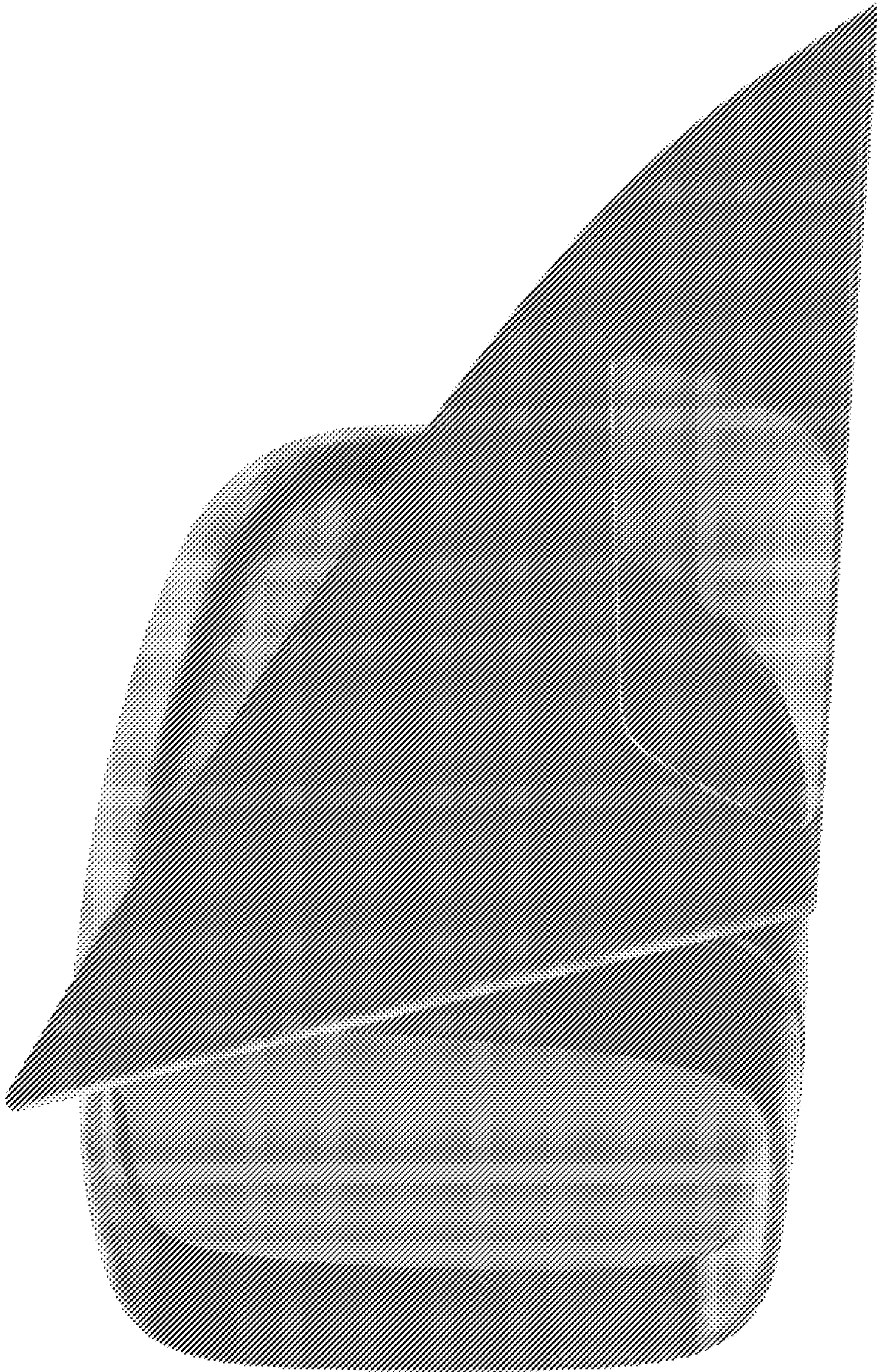

Figure 8