



US00D606415S

(12) **United States Design Patent**
Lavigne et al.

(10) **Patent No.:** **US D606,415 S**
(45) **Date of Patent:** **** Dec. 22, 2009**

(54) **FRAGRANCE BOTTLE**

AU 152851 8/2003

(Continued)

(75) Inventors: **Richard Lavigne**, Hastings-on-Hudson, NY (US); **Elizabeth Bogert**, Croton on Hudson, NY (US)

Primary Examiner—Stella M Reid

Assistant Examiner—Elizabeth J Oswecki

(74) *Attorney, Agent, or Firm*—Cynthia R. Miller

(73) Assignee: **Michael Kors, L.L.C.**, New York, NY (US)

(57) **CLAIM**

(**) Term: **14 Years**

The ornamental design for a fragrance bottle, substantially as shown and described.

(21) Appl. No.: **29/337,253**

(22) Filed: **May 18, 2009**

DESCRIPTION

(51) **LOC (9) Cl.** **09-01**

FIG. 1 is a top, front, right side perspective view of a first embodiment of a fragrance bottle showing our new design;

(52) **U.S. Cl.** **D9/546**; D9/434; D9/544; D9/564; D9/566

FIG. 2 is a front elevation view thereof, the rear elevation view being identical thereto;

(58) **Field of Classification Search** D9/434, D9/435, 439, 682, 686, 687, 694, 516, 529, D9/544, 546, 559, 560, 564, 566, 568, 569, D9/574; 215/381–385

FIG. 3 is a side elevation view thereof, the opposite side elevation view being identical thereto;

See application file for complete search history.

FIG. 4 is a top plan view thereof;

FIG. 5 is a bottom plan view thereof;

(56) **References Cited**

FIG. 6 is a top, front, right side, perspective view of a second embodiment of a fragrance bottle showing our new design;

U.S. PATENT DOCUMENTS

FIG. 7 is a front elevation view thereof, the rear elevation view being identical thereto;

D45,375 S *	3/1914	Dunnook	D9/658
D61,829 S *	1/1923	Javal	D9/544
D76,142 S *	8/1928	Liddel	D9/544
D81,633 S *	7/1930	Wagner	D9/520
D88,737 S	12/1932	McCormick		
D92,078 S *	4/1934	Guerlain	D9/544
D93,147 S	8/1934	Titus		
D94,786 S *	3/1935	Stein	D9/566
D112,782 S	1/1939	McIntosh		
D141,775 S *	7/1945	Buckingham	D9/544
D143,657 S *	1/1946	Graham	D9/544
D152,473 S *	1/1949	Heim	D9/607
D172,090 S	5/1954	Du Pree		

FIG. 8 is a side elevation view thereof, the opposite side elevation view being identical thereto;

FIG. 9 is a top plan view thereof;

FIG. 10 is a bottom plan view thereof;

FIG. 11 is a top, front, right side, perspective view of a third embodiment of a fragrance bottle showing our new design;

FIG. 12 is a front elevation view thereof, the rear elevation view being identical thereto;

FIG. 13 is a side elevation view thereof, the opposite side elevation view being identical thereto;

FIG. 14 is a top plan view thereof; and,

FIG. 15 is a bottom plan view thereof.

(Continued)

FOREIGN PATENT DOCUMENTS

AU 138098 8/1999

1 Claim, 6 Drawing Sheets

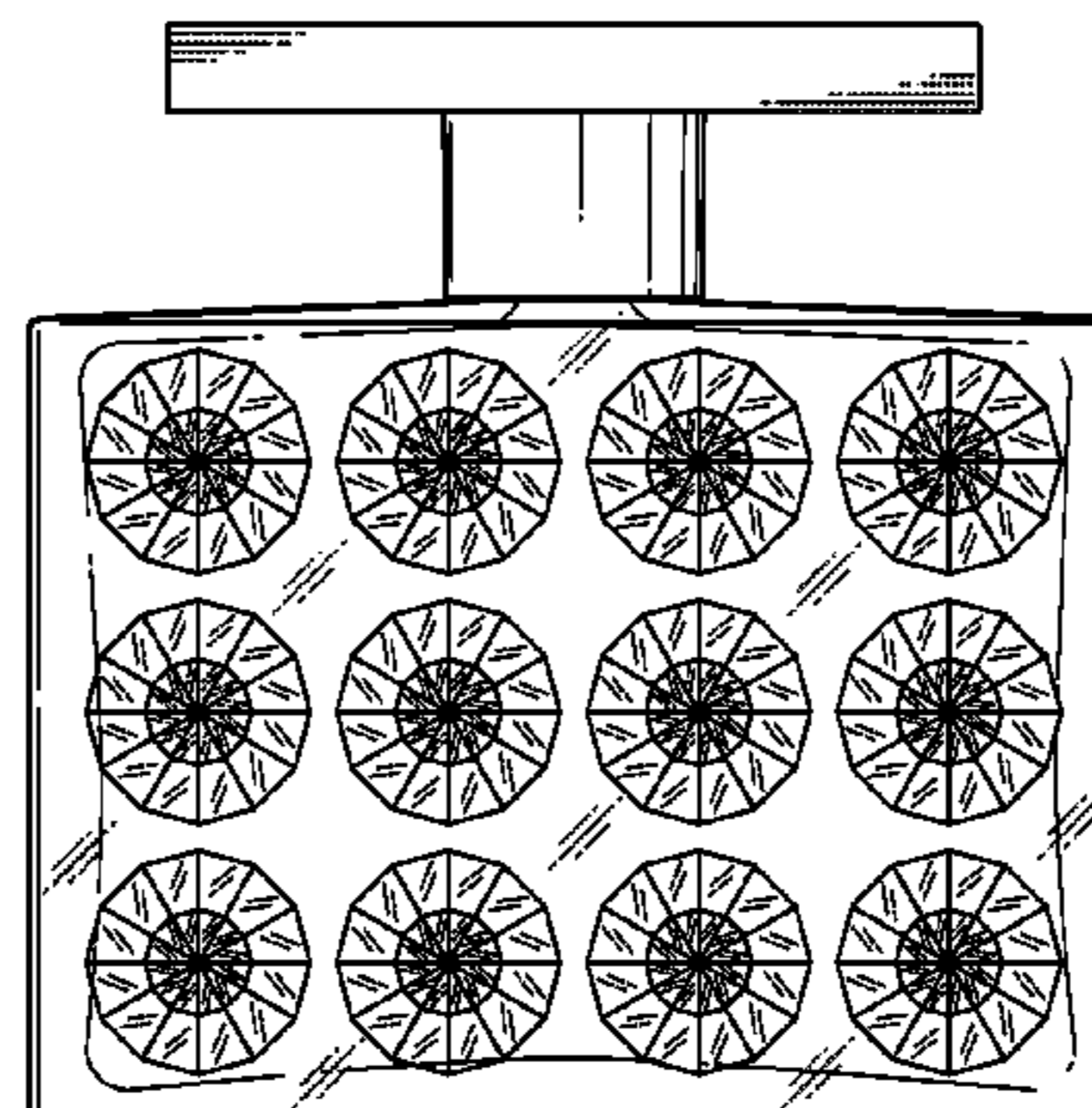
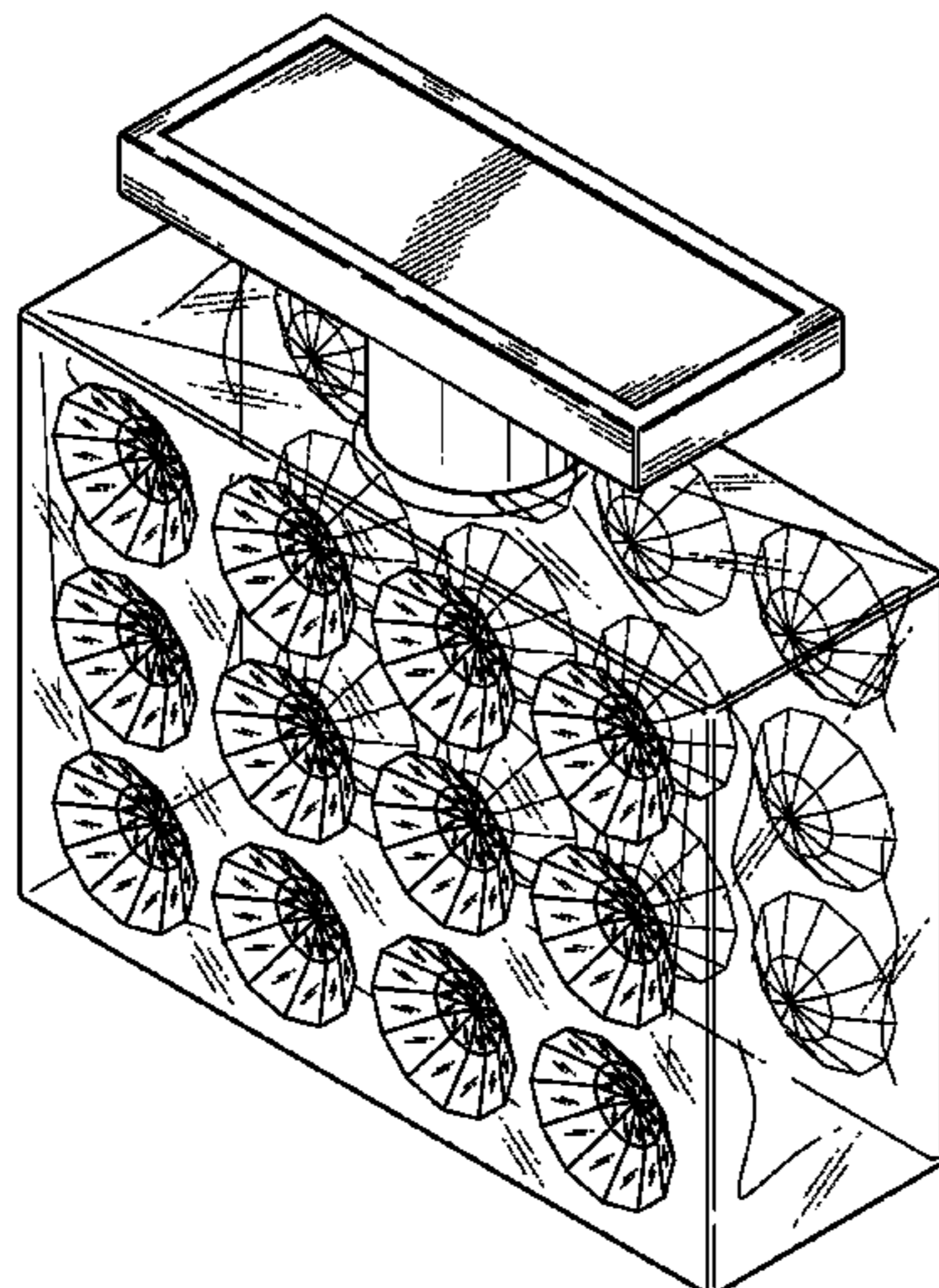

US D606,415 S

Page 2

U.S. PATENT DOCUMENTS

D197,673 S 3/1964 Goodall
D243,066 S 1/1977 Halsted et al.
D247,281 S * 2/1978 Grodin D9/564
D257,954 S * 1/1981 Grodin D9/564
D324,820 S * 3/1992 Hayman et al. D9/544
D397,039 S 8/1998 Dickson et al.
D420,596 S * 2/2000 Maddy D9/560
D430,037 S * 8/2000 Granai D9/544
D431,190 S 9/2000 Adachi et al.
D448,307 S 9/2001 Handler
D459,209 S * 6/2002 Yamamoto D9/687
D474,693 S * 5/2003 Gruosi-Scheufele D9/544
D484,790 S * 1/2004 Sgariboldi D9/694
D484,791 S * 1/2004 Sgariboldi D9/694
D510,276 S 10/2005 de France
D537,725 S * 3/2007 Varlet D9/544
D542,670 S 5/2007 Herrmann
D546,192 S * 7/2007 Faillant Dumas D9/571
D574,257 S * 8/2008 Zeidan D9/694
D576,052 S * 9/2008 Lloyd et al. D9/694
D577,600 S * 9/2008 Kim et al. D9/573
D587,596 S * 3/2009 Lloyd D9/694

D600,133 S * 9/2009 Friedman et al. D9/560

FOREIGN PATENT DOCUMENTS

AU 306016 3/2006
AU 315242 7/2007
AU 320068 6/2008
AU 324458 2/2009
EM 000569884-0001 10/2006
EM 000790365-0001 10/2007
EM 001099493-0001 3/2009
RU 41844 10/1995
RU 49539 11/2001
RU 56013 1/2005
RU 56265 2/2005
RU 48783 5/2005
RU 68019 10/2008
SA 10 6/2005
SA 121 4/2006
SA 224 8/2006
SA 267 11/2006
SA 480 11/2007
SA 720 7/2008
WO DM/064332 10/2003

* cited by examiner

FIG. 1

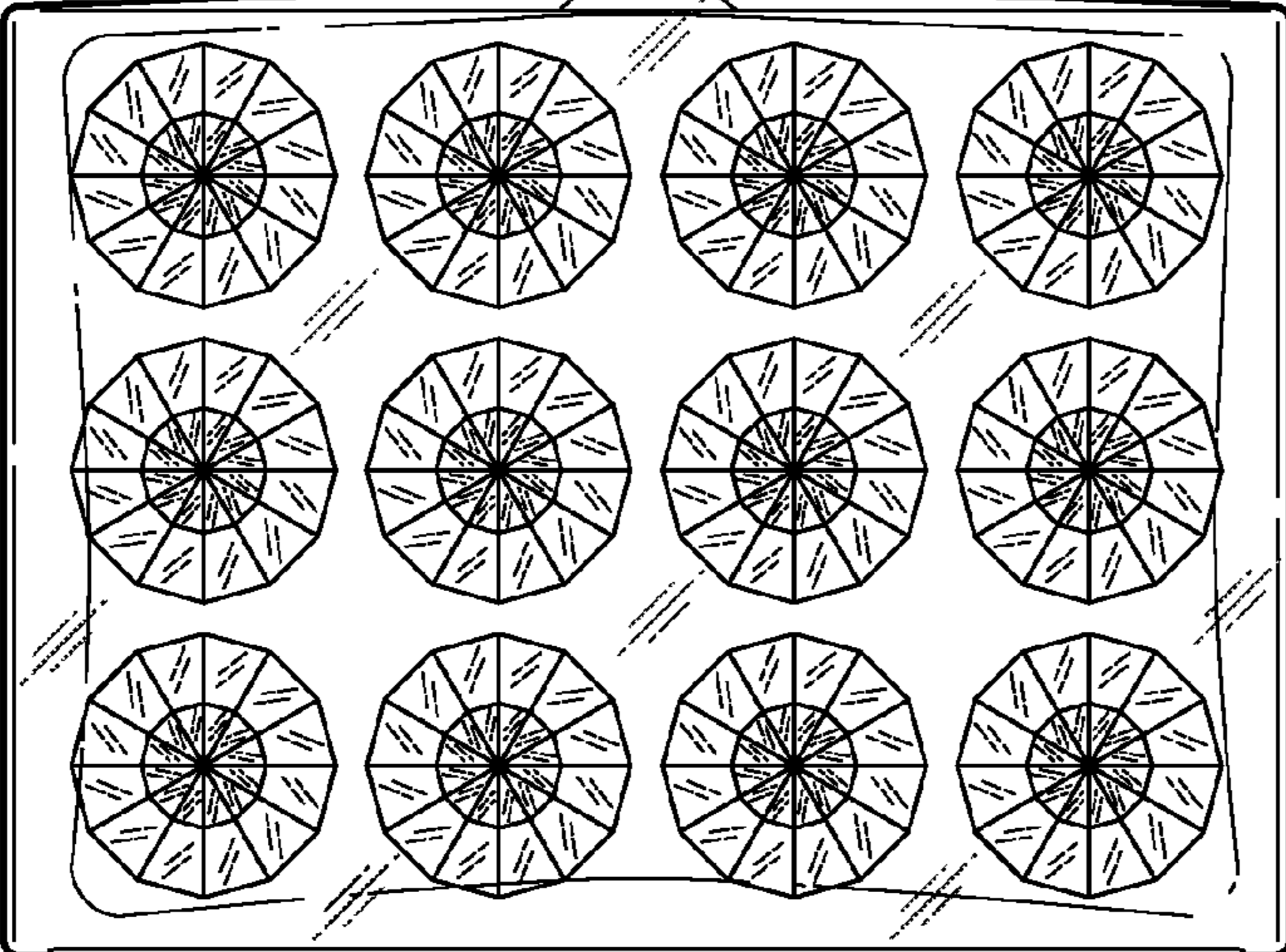
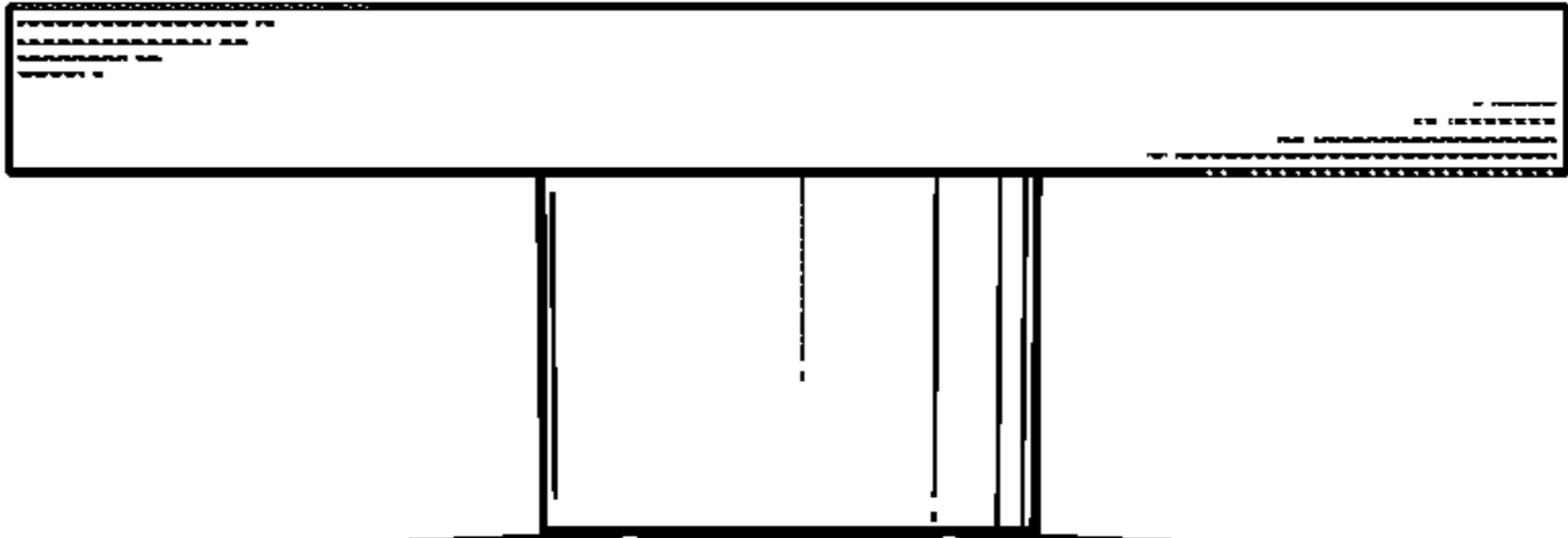
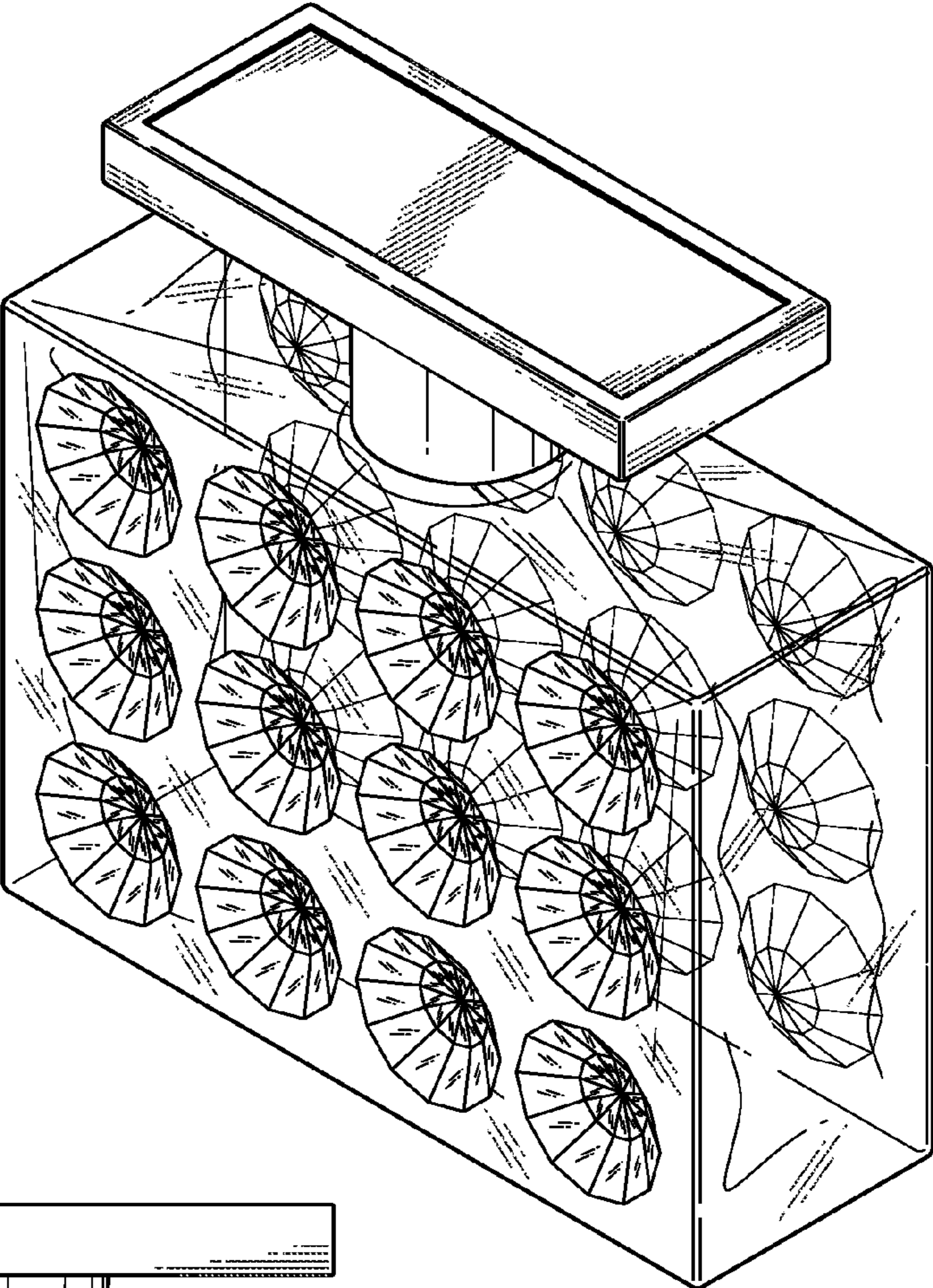

FIG. 2

FIG. 3

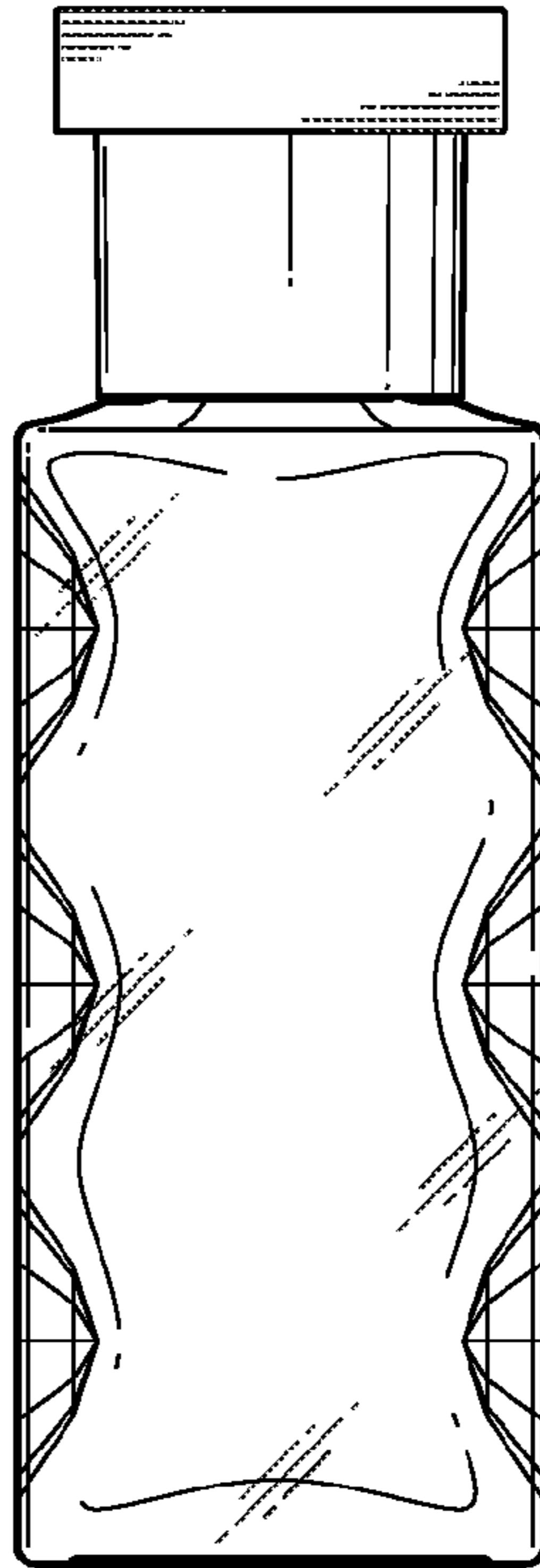

FIG. 4

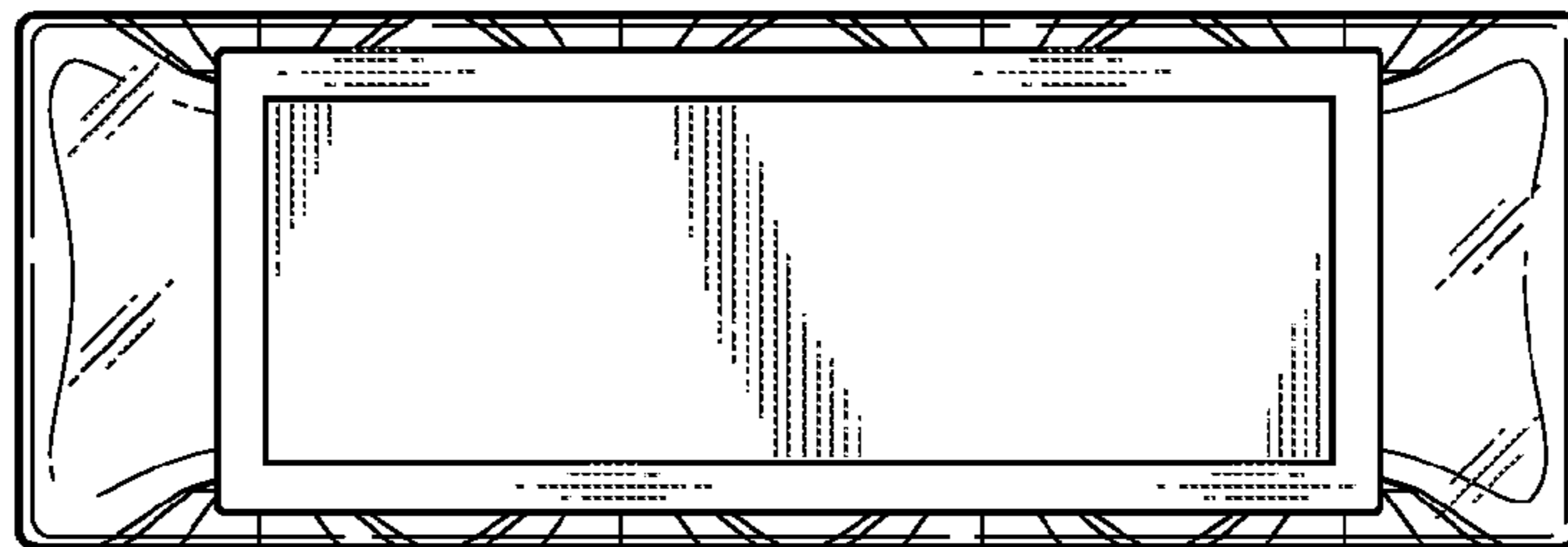

FIG. 5

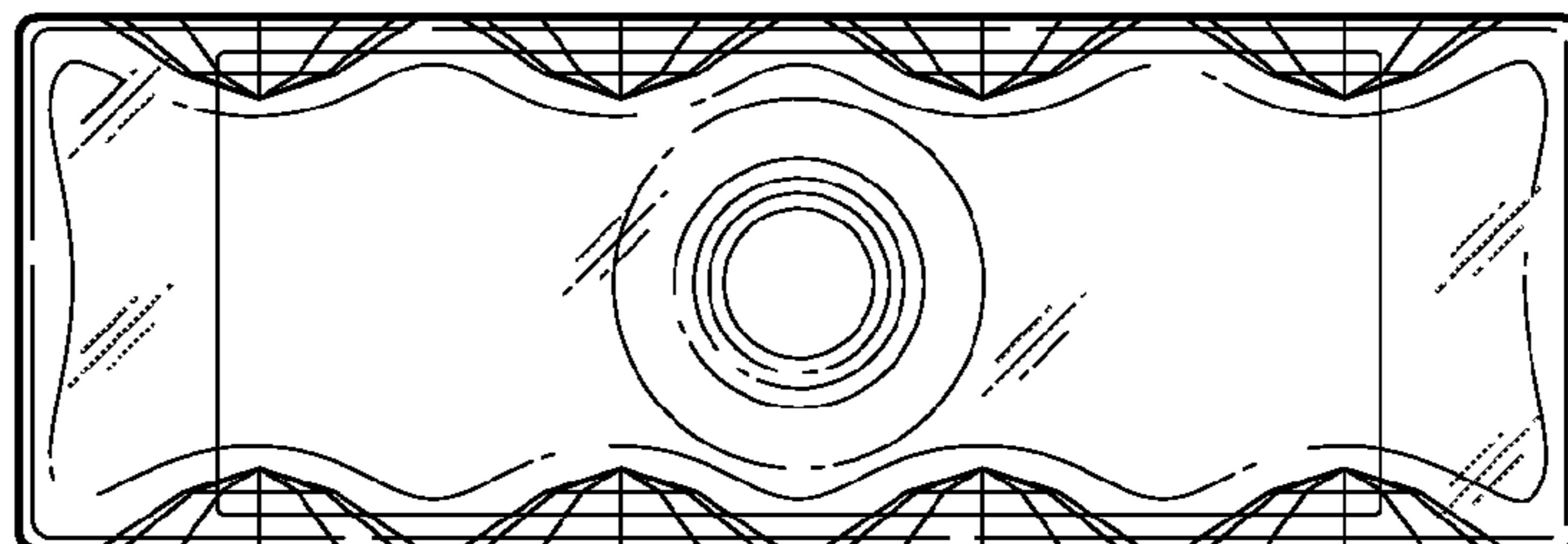

FIG. 6

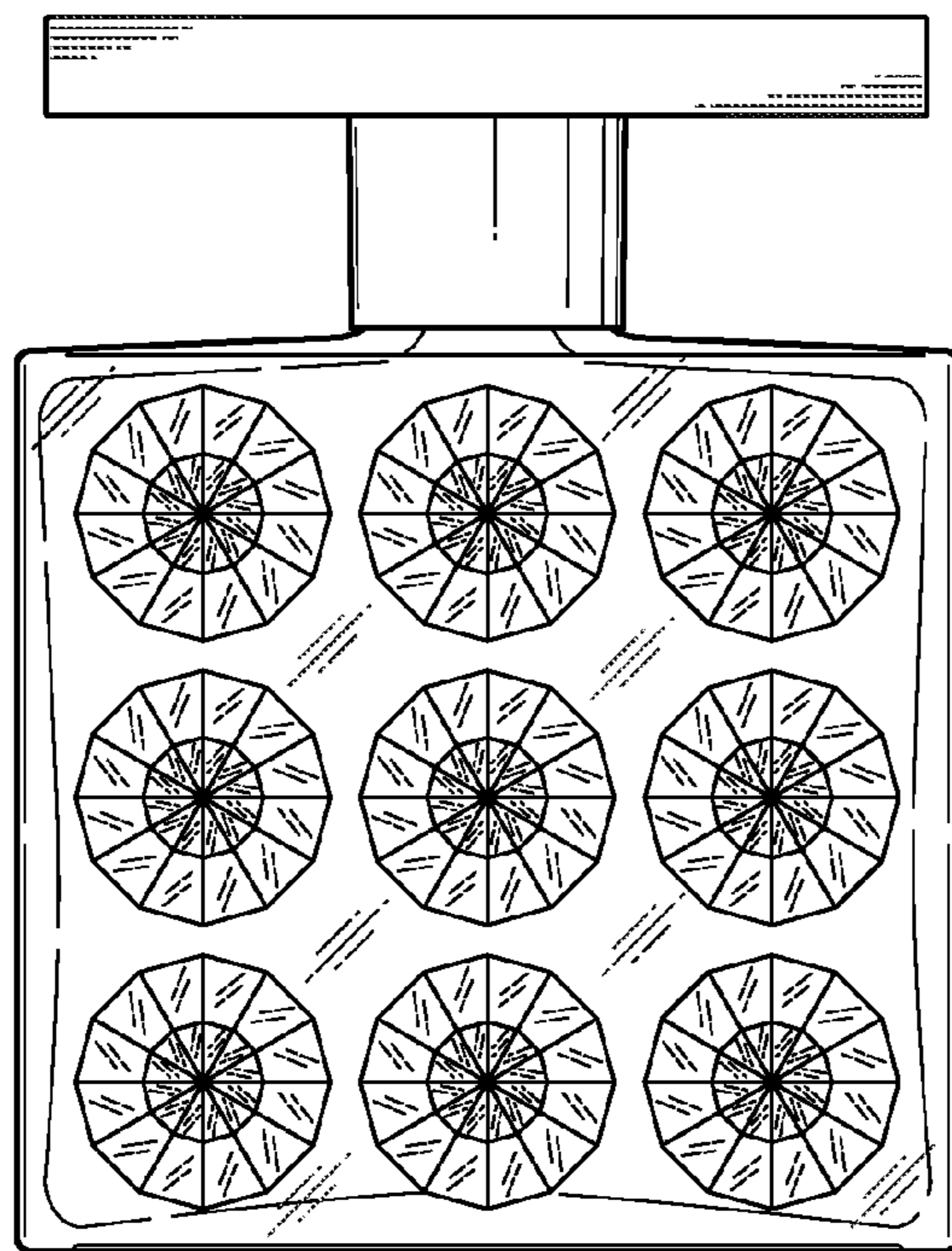
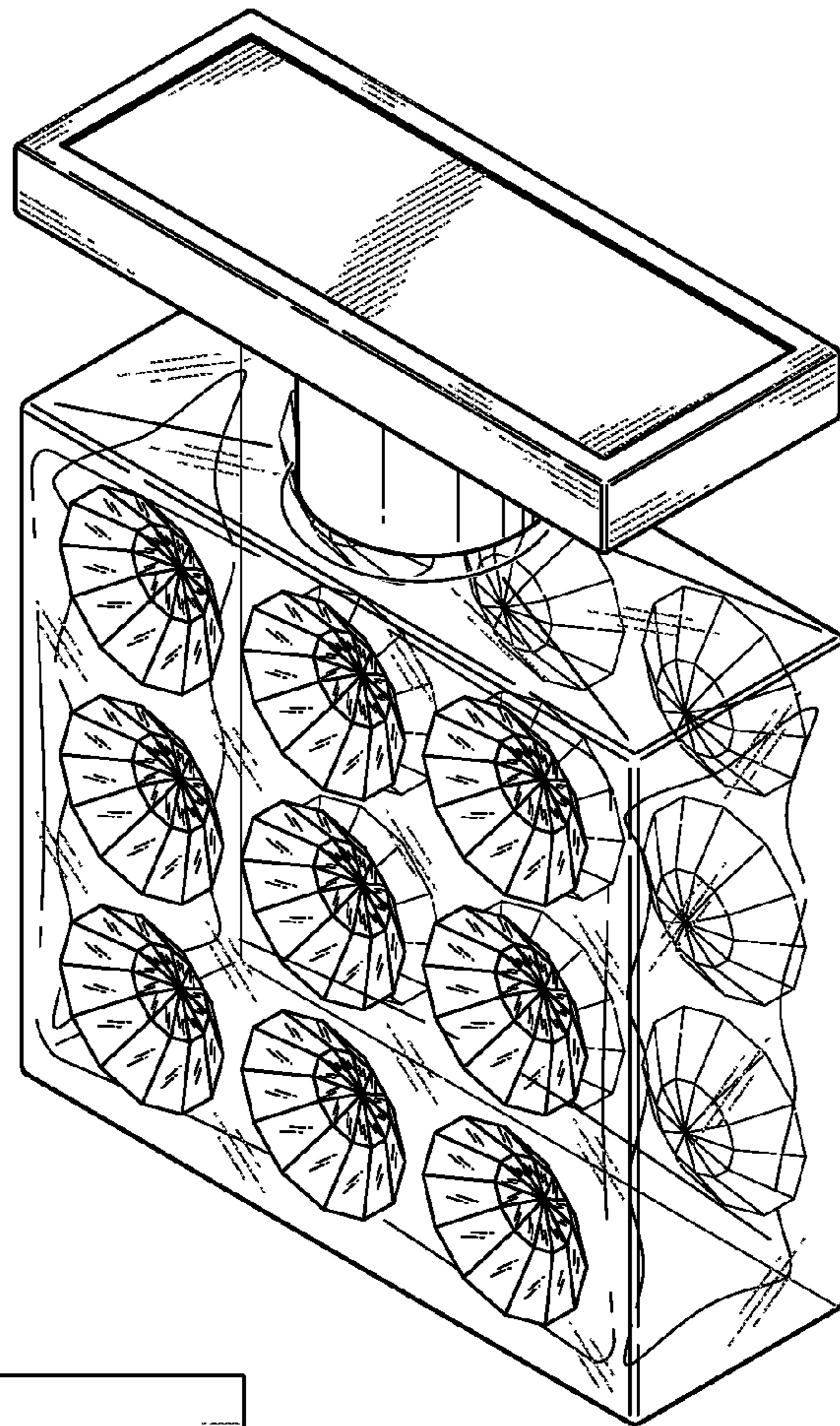

FIG. 7

FIG. 8

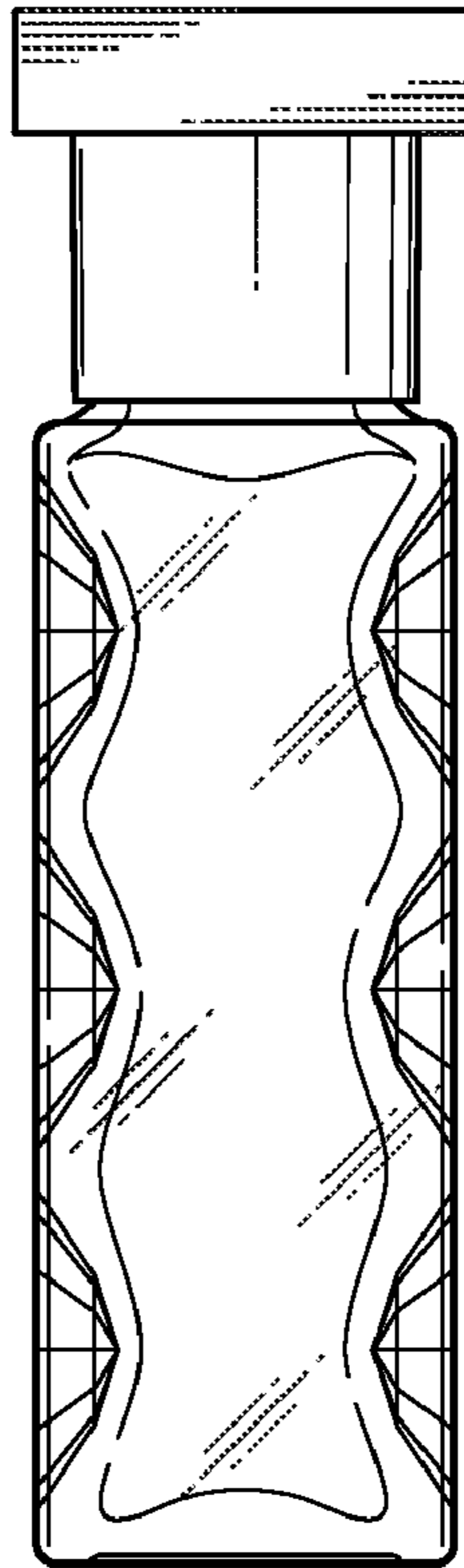

FIG. 9

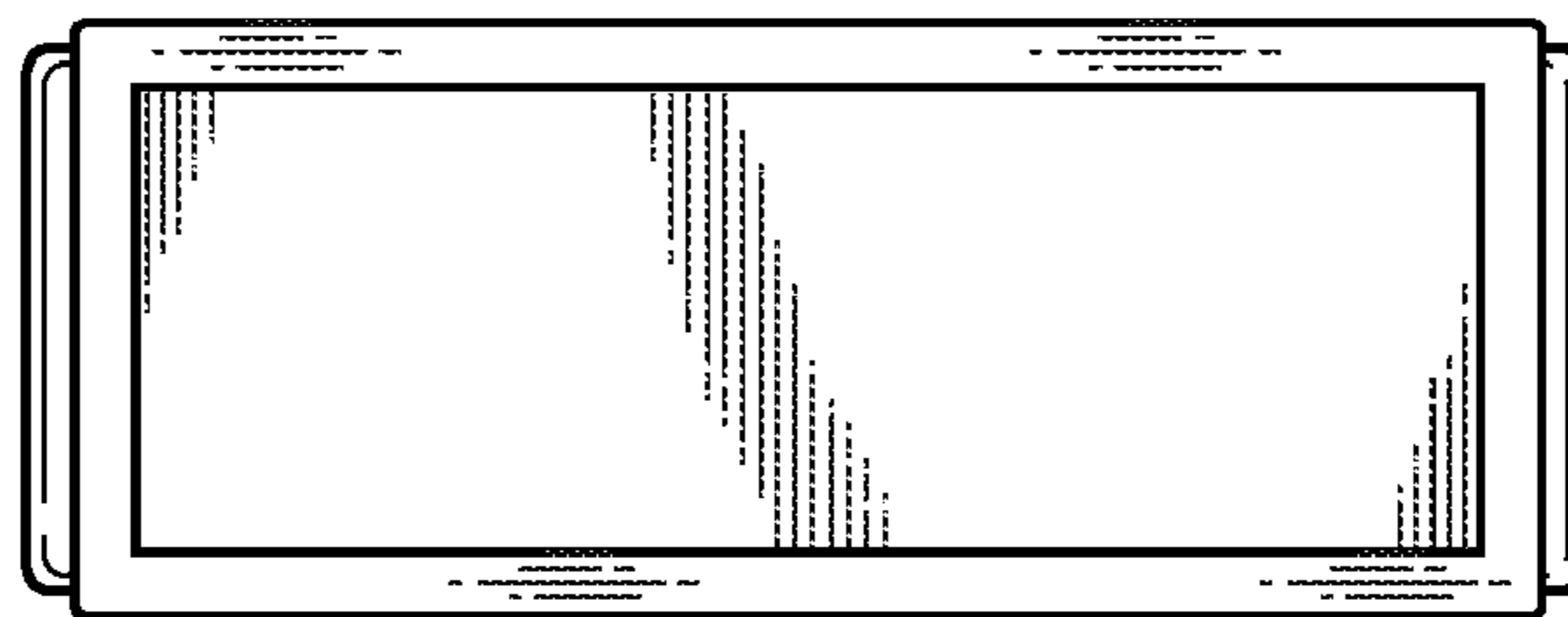

FIG. 10

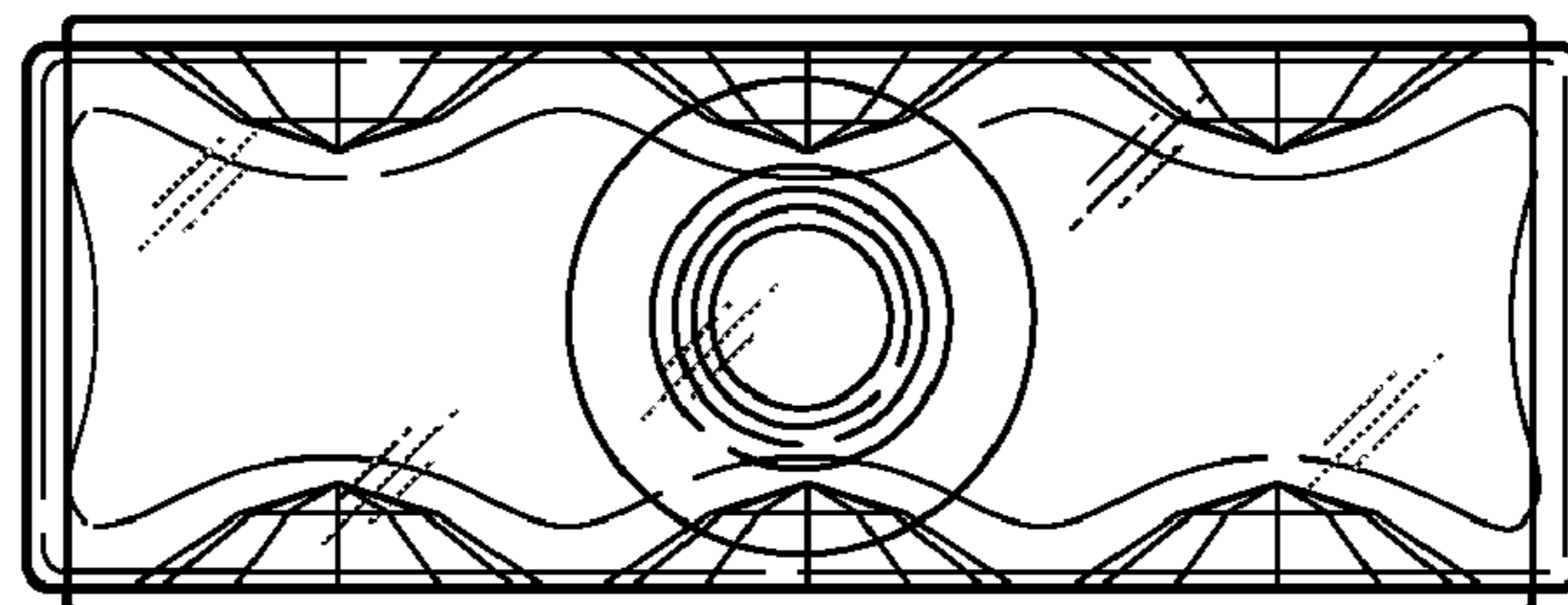

FIG. 11

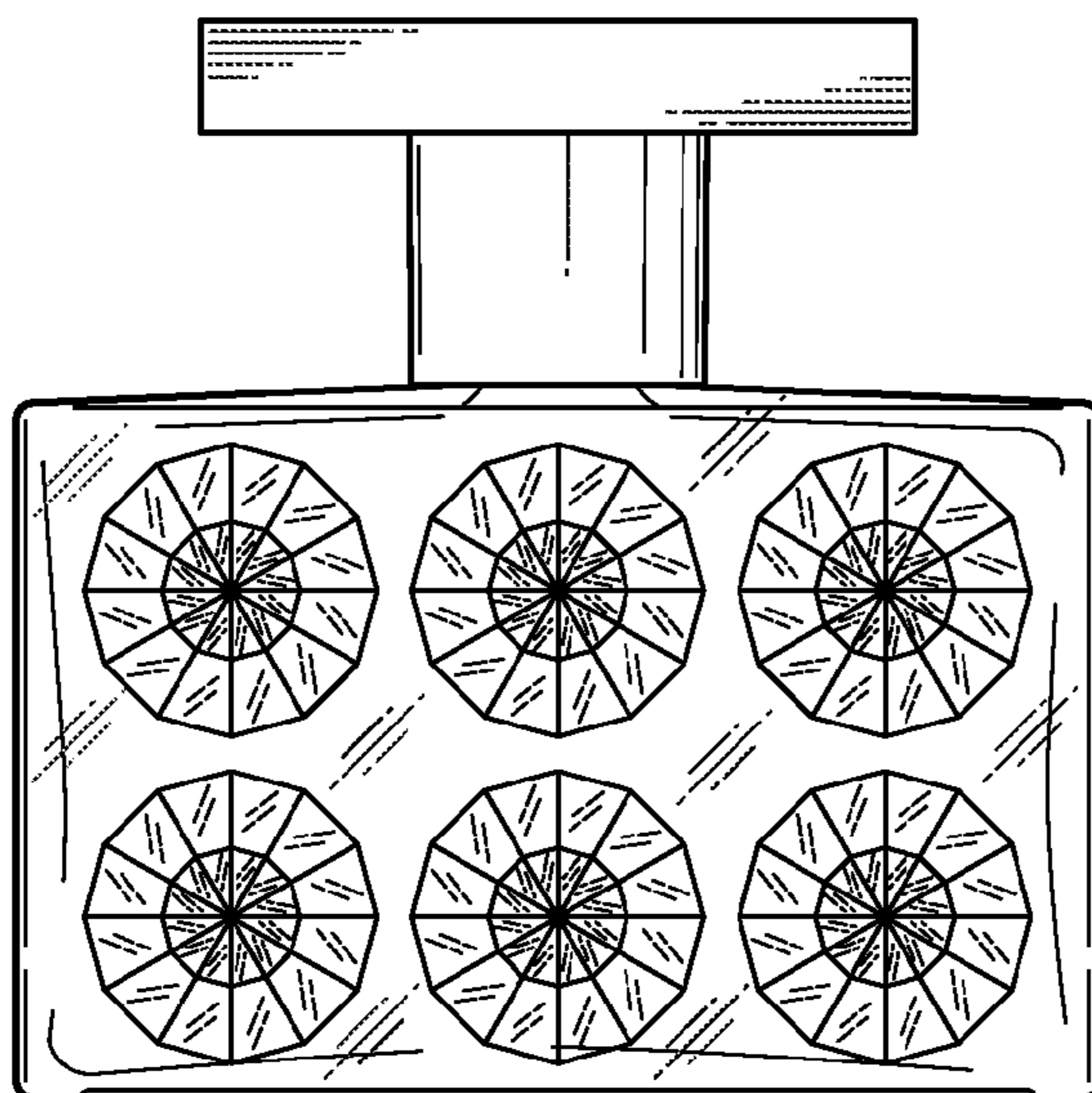
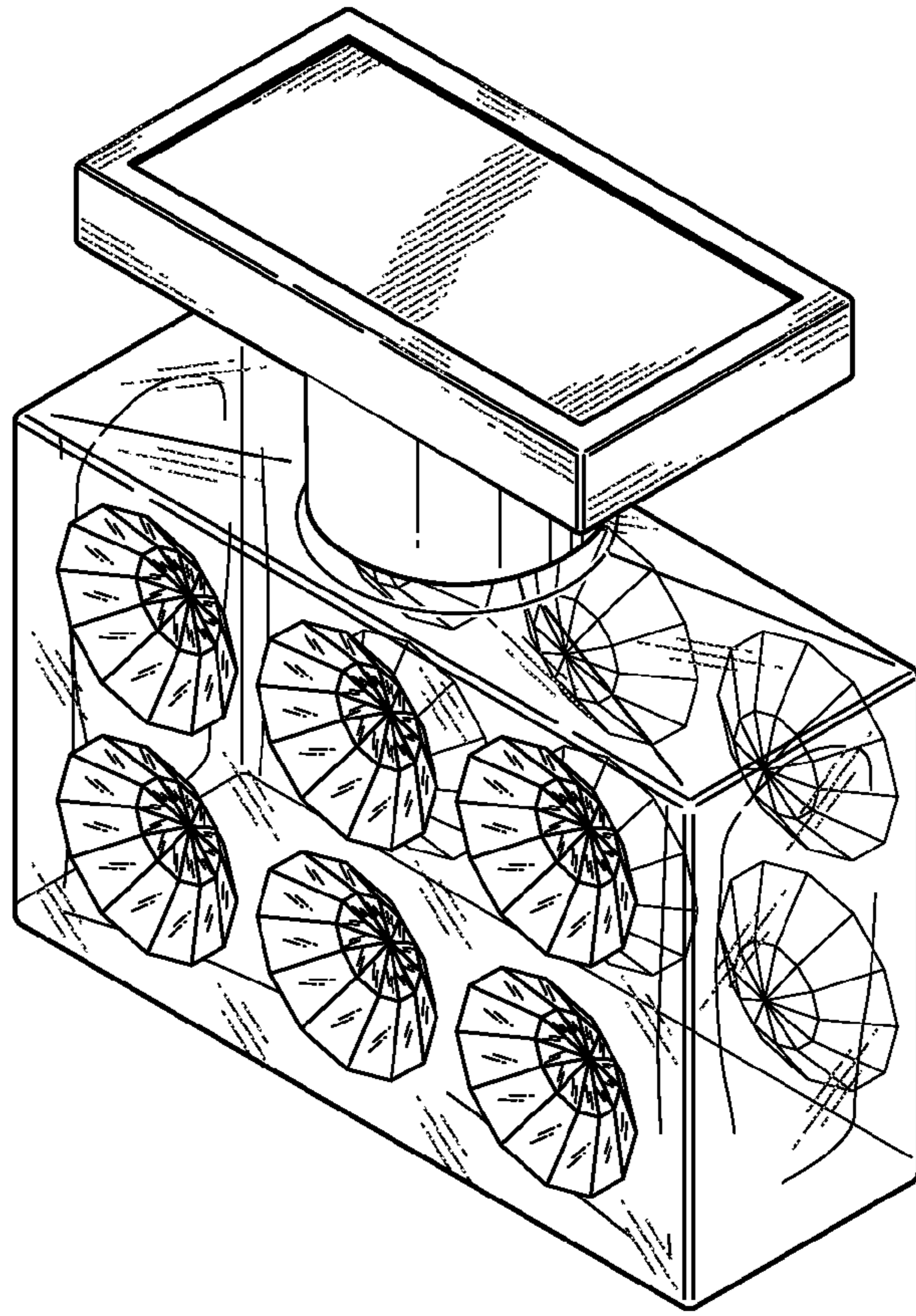

FIG. 12

FIG. 13

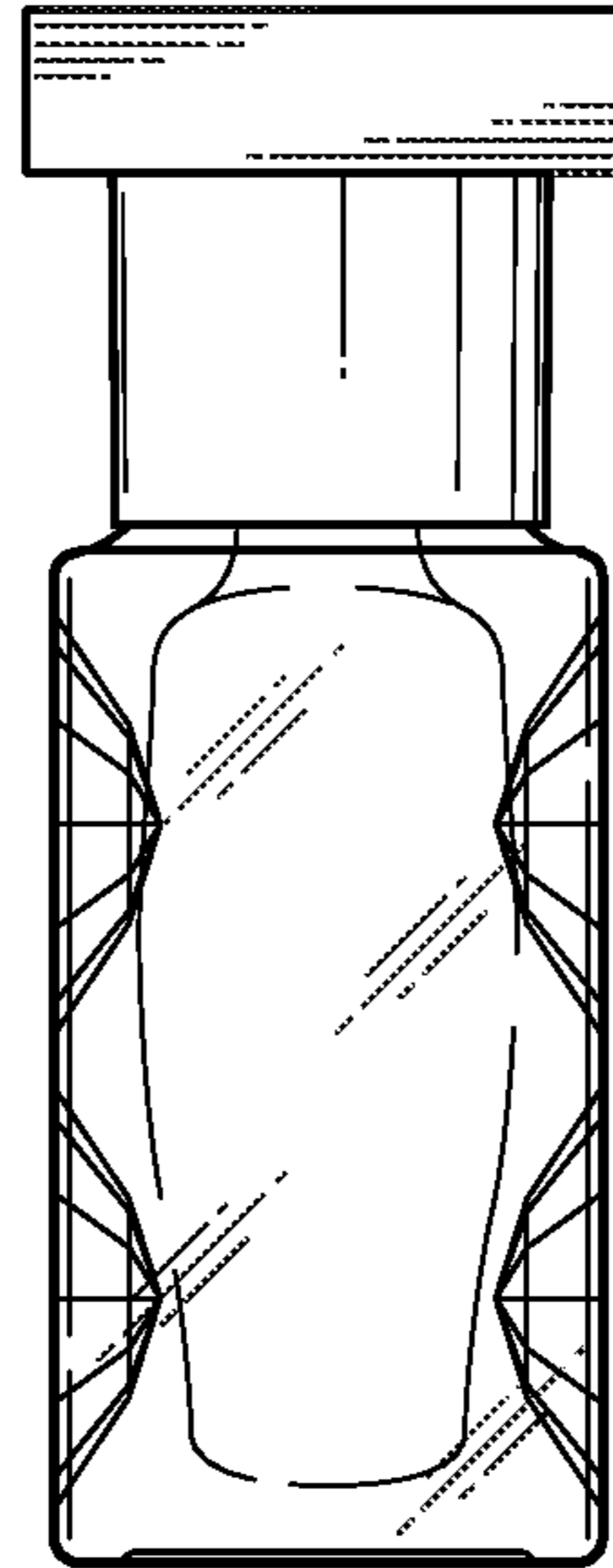

FIG. 14

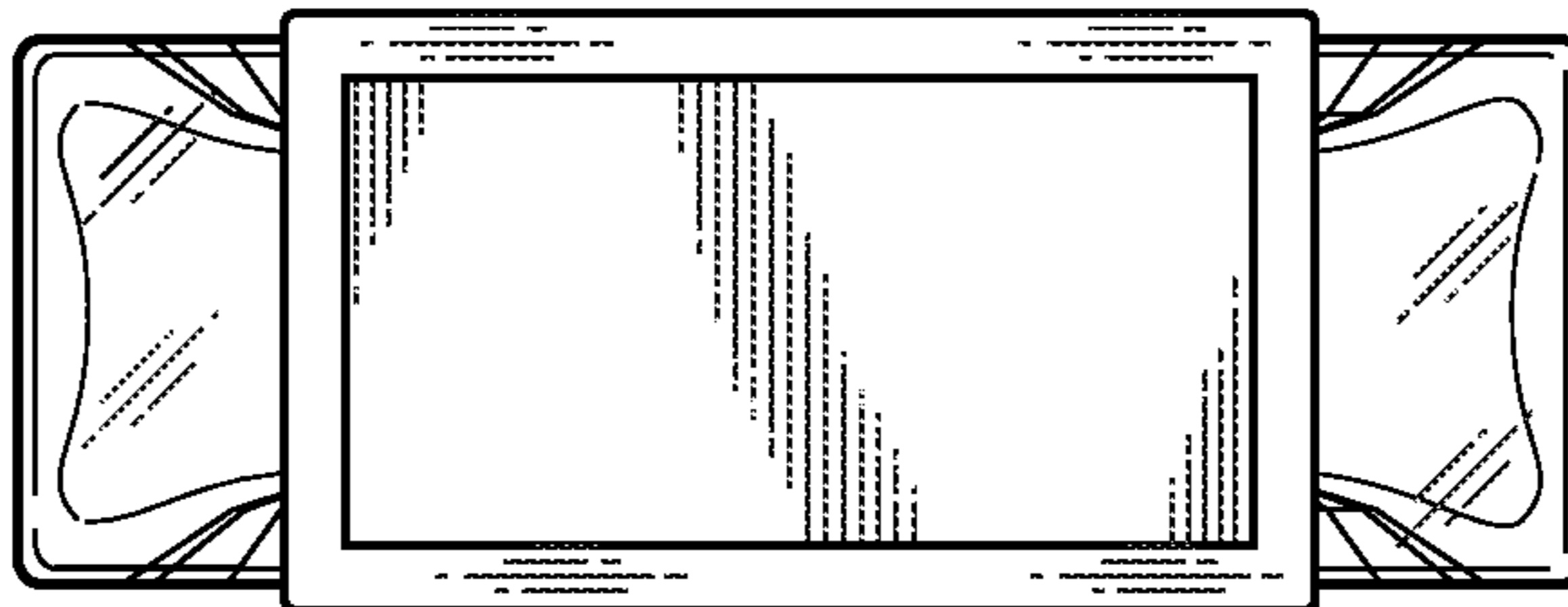

FIG. 15

