



US00D606385S

(12) **United States Design Patent**  
**Hansson et al.**

(10) **Patent No.:** **US D606,385 S**  
(45) **Date of Patent:** **\*\* Dec. 22, 2009**

(54) **BEAM SUPPORT BRACKET**

(75) Inventors: **Martin Hansson**, Alafors (SE); **Anders Jonsson**, Torslanda (SE); **Göran Abbestam**, Partille (SE)

(73) Assignee: **FlexLink Components AB**, Göteborg (SE)

(\*\*) Term: **14 Years**

(21) Appl. No.: **29/336,389**

(22) Filed: **May 1, 2009**

**Related U.S. Application Data**

(62) Division of application No. 29/295,002, filed on Sep. 19, 2007.

(51) **LOC (9) Cl.** ..... **08-05**

(52) **U.S. Cl.** ..... **D8/380**

(58) **Field of Classification Search** ..... D8/40,  
D8/394, 381, 380, 373, 366, 354, 353, 349;  
D25/132, 131, 126, 119; 52/687, 686, 506.07,  
52/506.06, 426; 248/267, 265, 208, 243  
See application file for complete search history.

(56) **References Cited**

U.S. PATENT DOCUMENTS

D553,458 S \* 10/2007 Hood ..... D8/40  
\* cited by examiner

*Primary Examiner*—Susan Bennett Hattan

(74) *Attorney, Agent, or Firm*—Schwegman, Lundberg & Woessner, P.A.

(57) **CLAIM**

The ornamental design for a beam support bracket, as shown and described.

**DESCRIPTION**

FIG. 1 is an isometric view of a second beam support bracket; FIG. 2 is a front view of the beam support bracket of FIG. 1; FIG. 3 is a first side view of the beam support bracket of FIG. 1;

FIG. 4 is a second side view of the beam support bracket of FIG. 1;

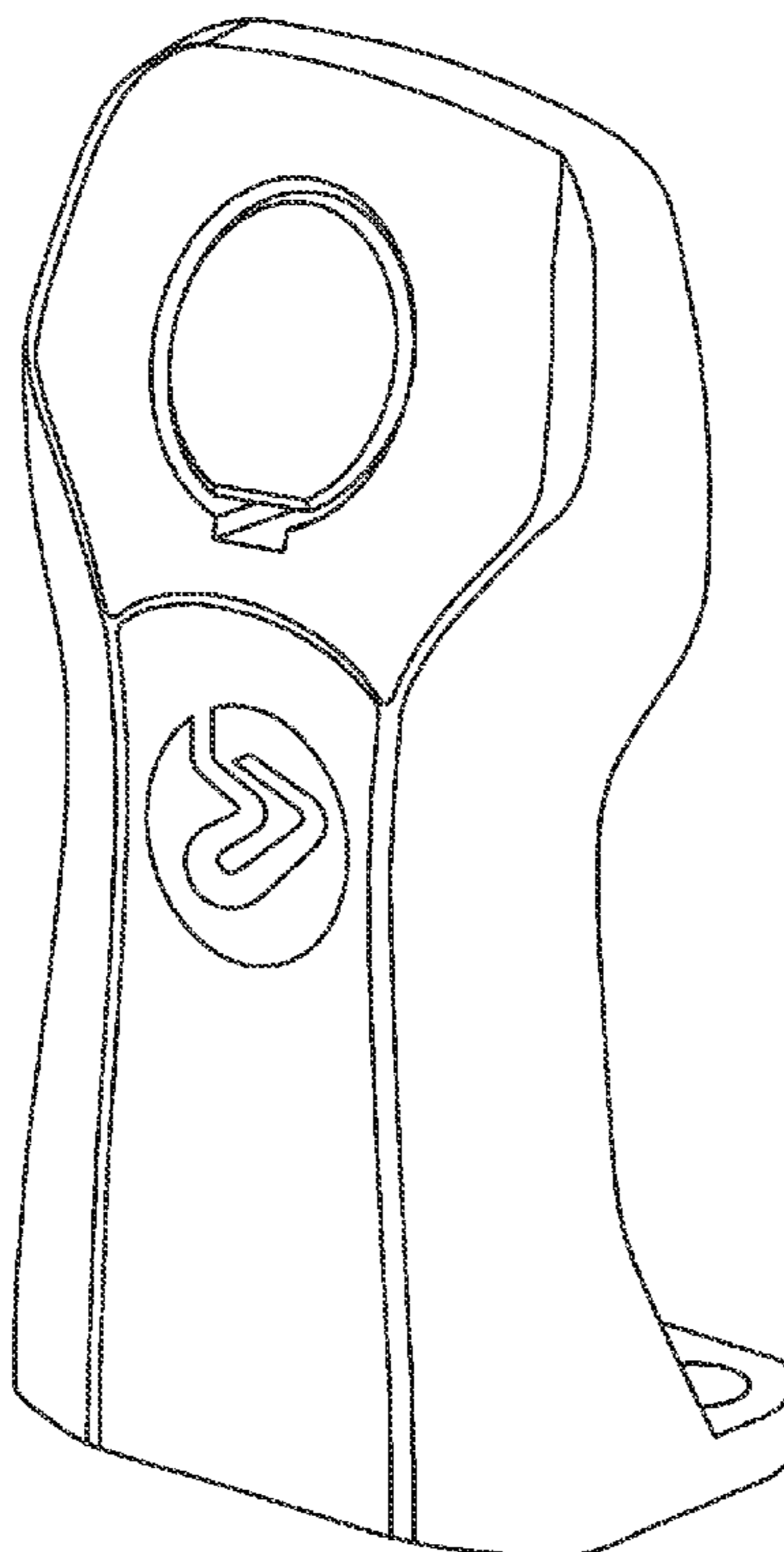
FIG. 5 is a bottom view of the beam support bracket of FIG. 1;

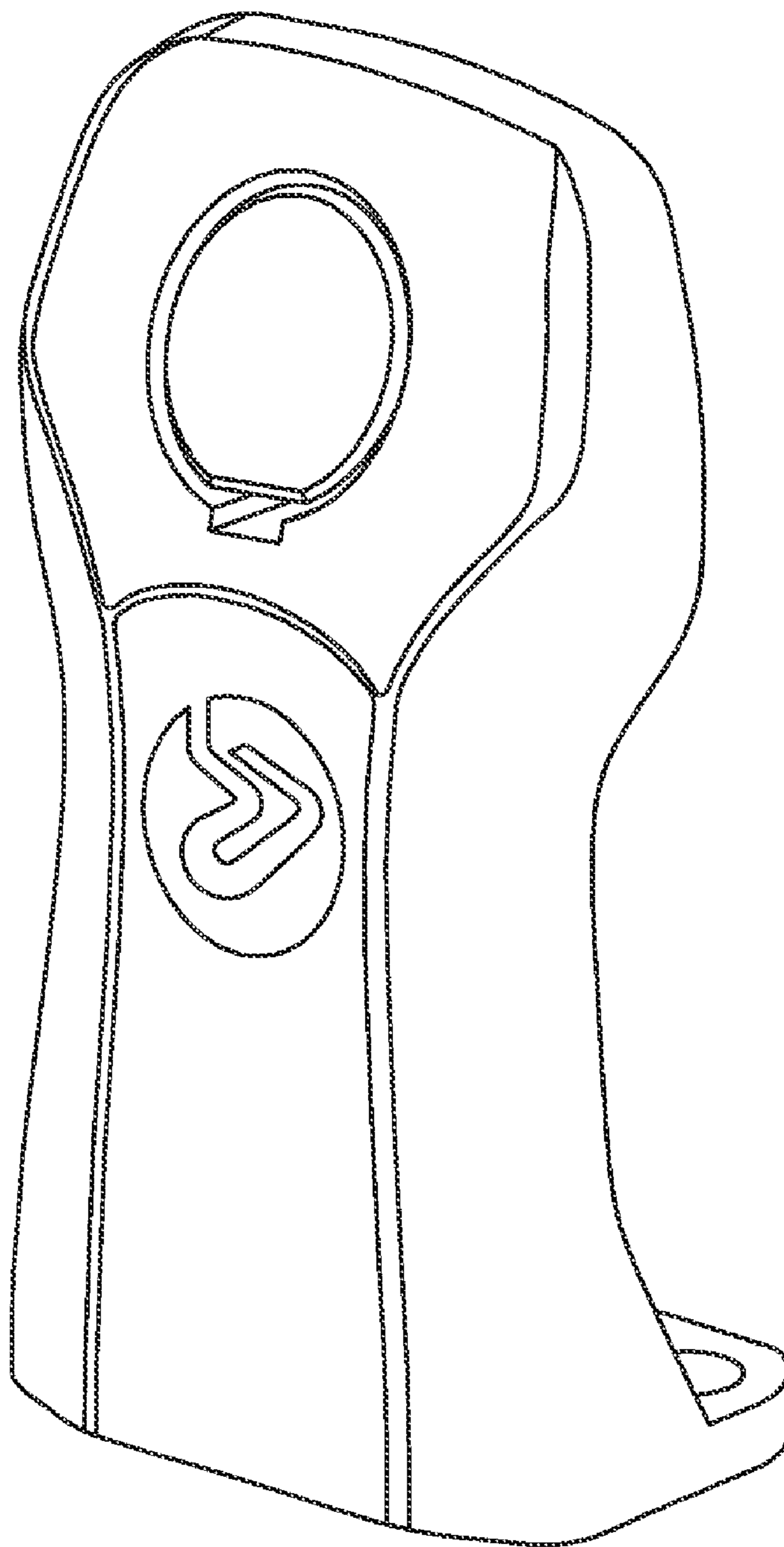
FIG. 6 is a top view of the beam support bracket of FIG. 1; and,

FIG. 7 is a rear view of the beam support bracket of FIG. 1.

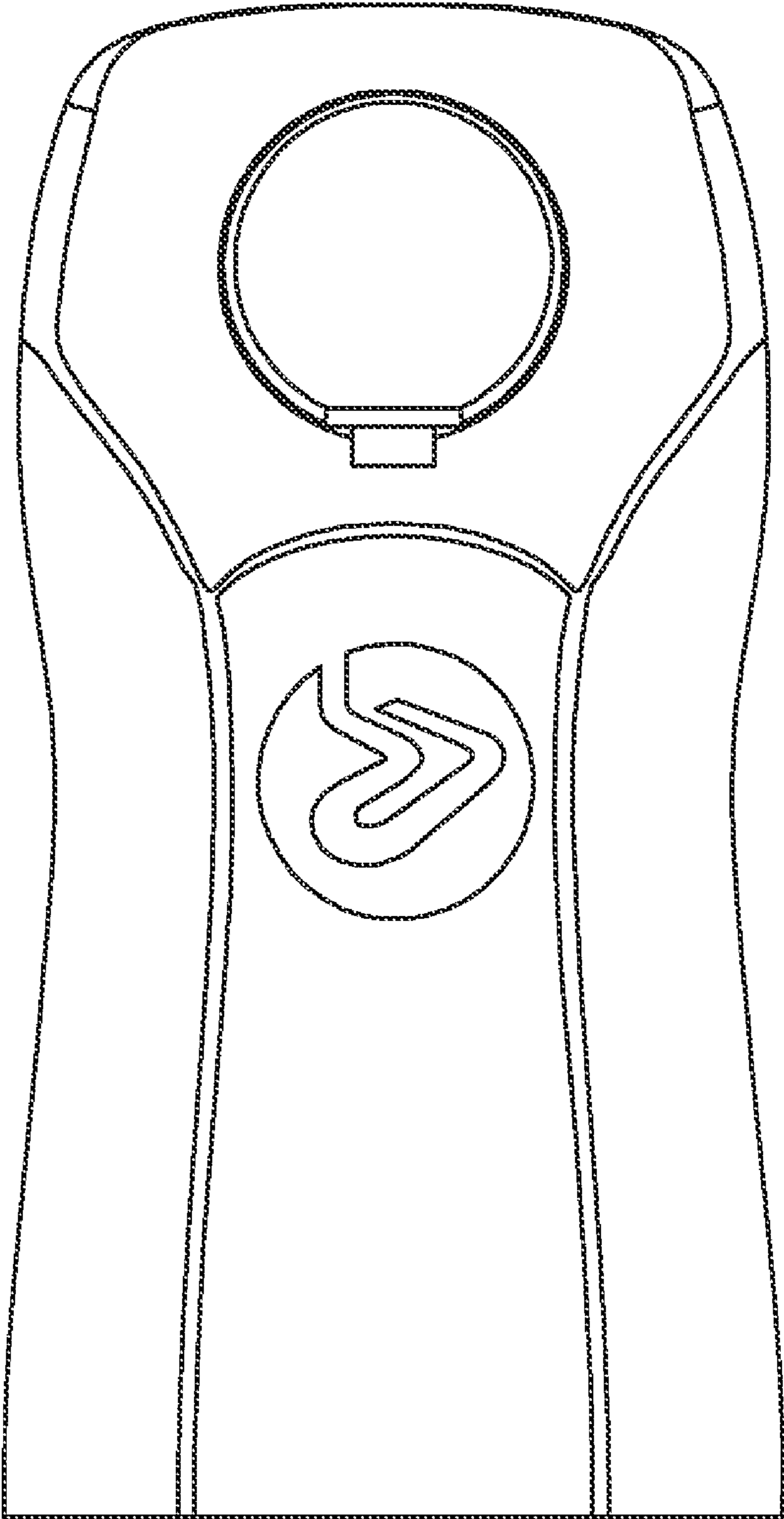
The broken line showing depicts environmental subject matter only and forms no part of the claimed design.

**1 Claim, 6 Drawing Sheets**

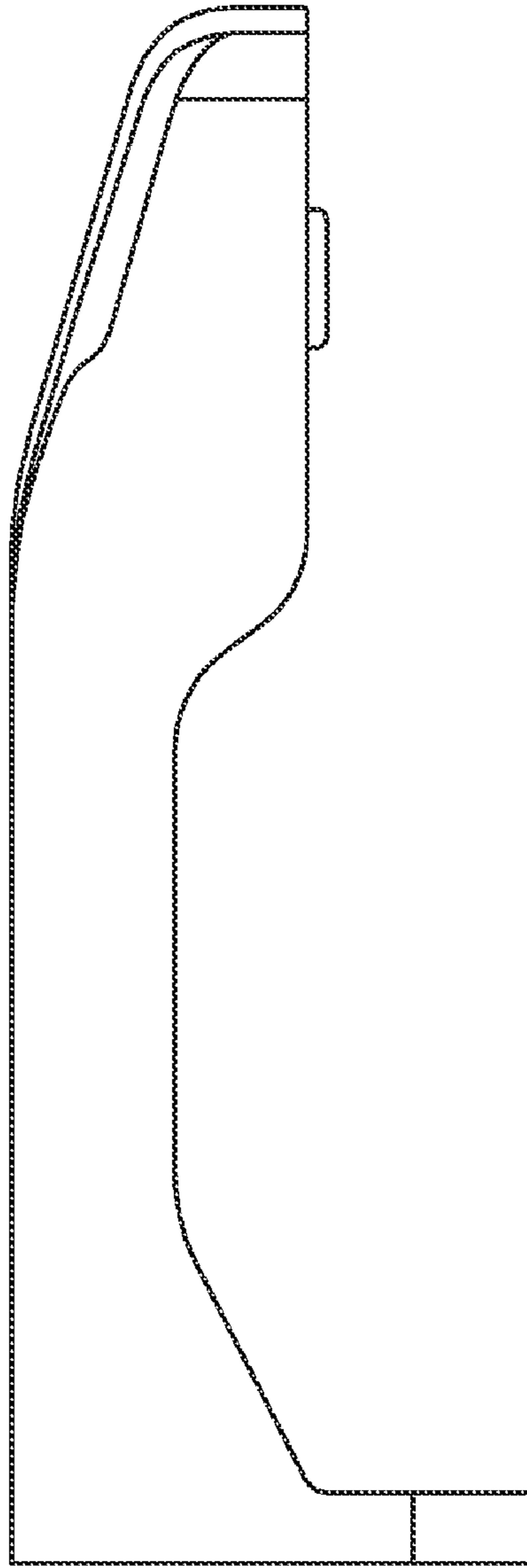




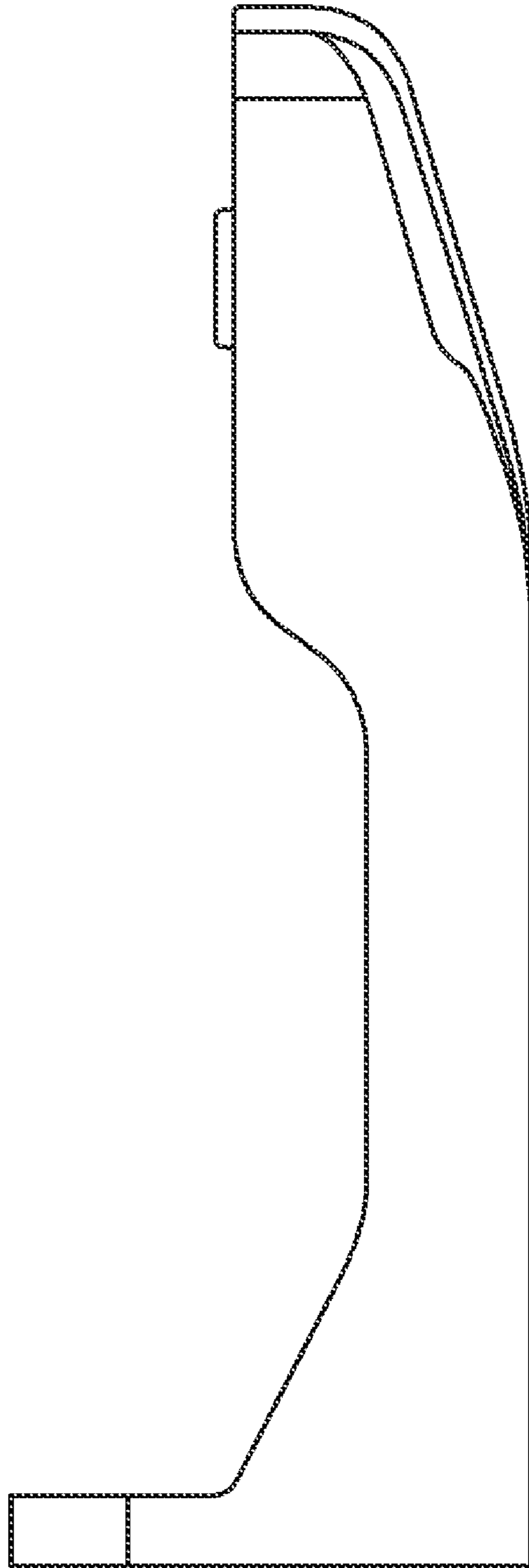
*Fig. 1*



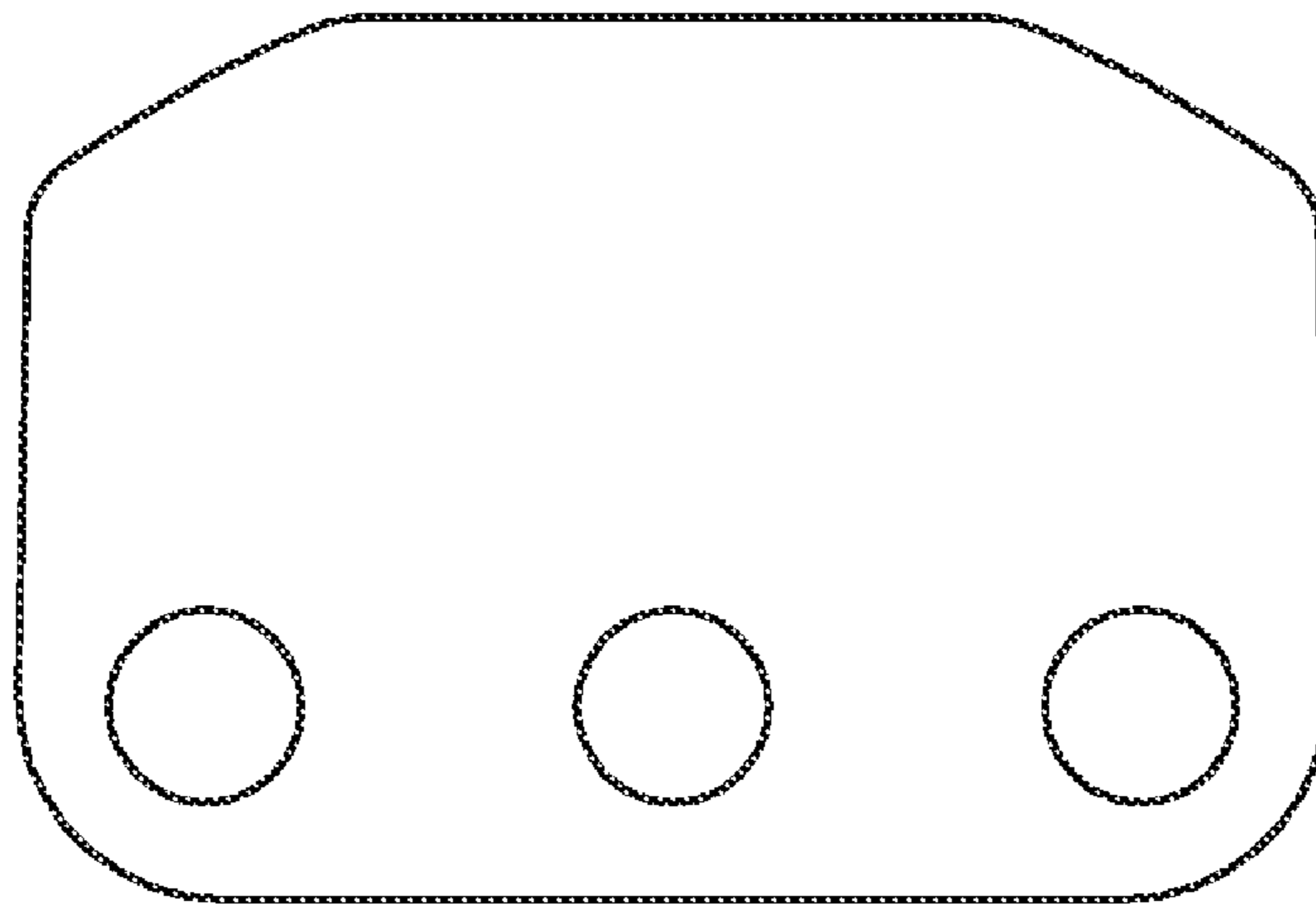
*Fig. 2*



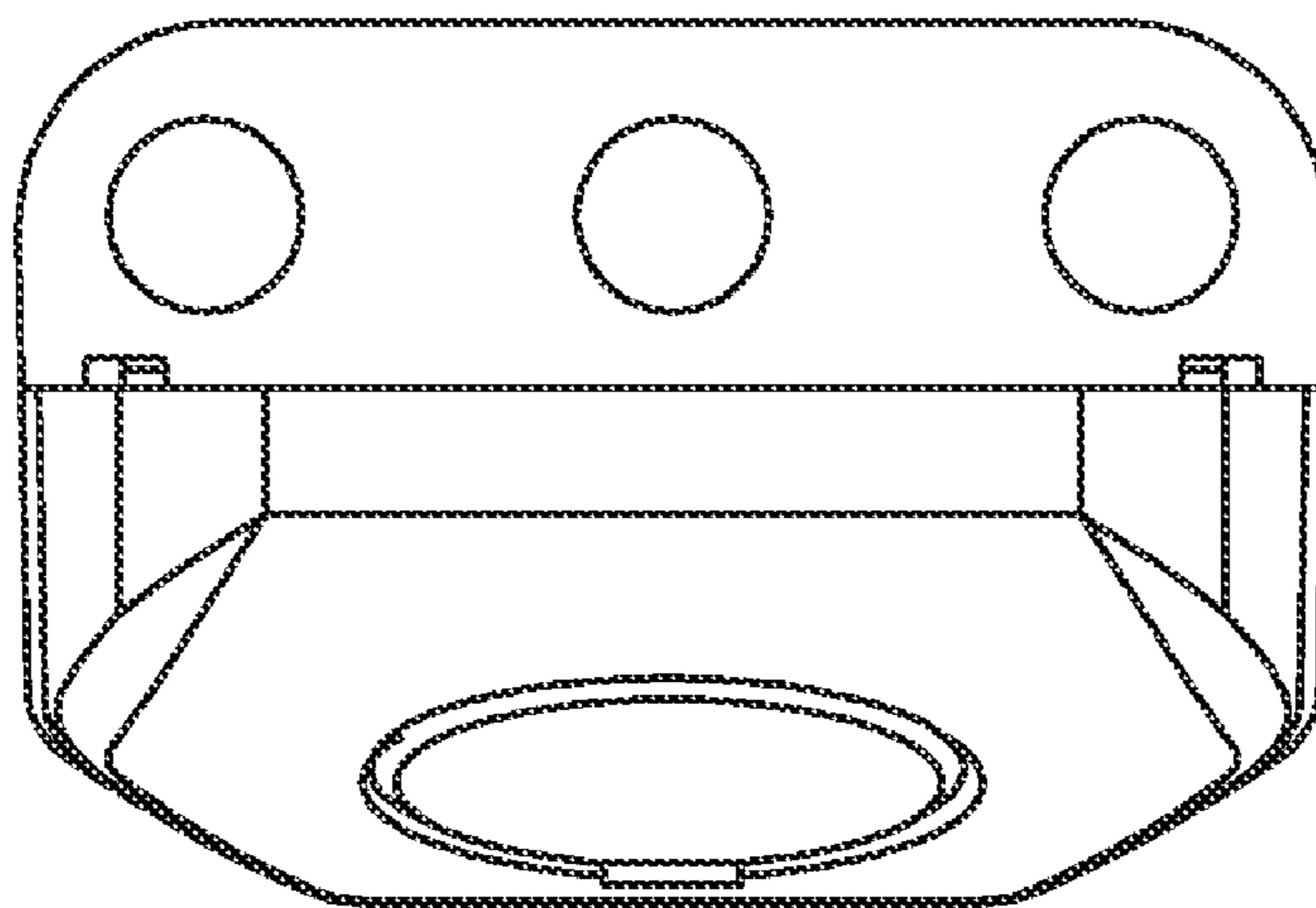
*Fig. 3*



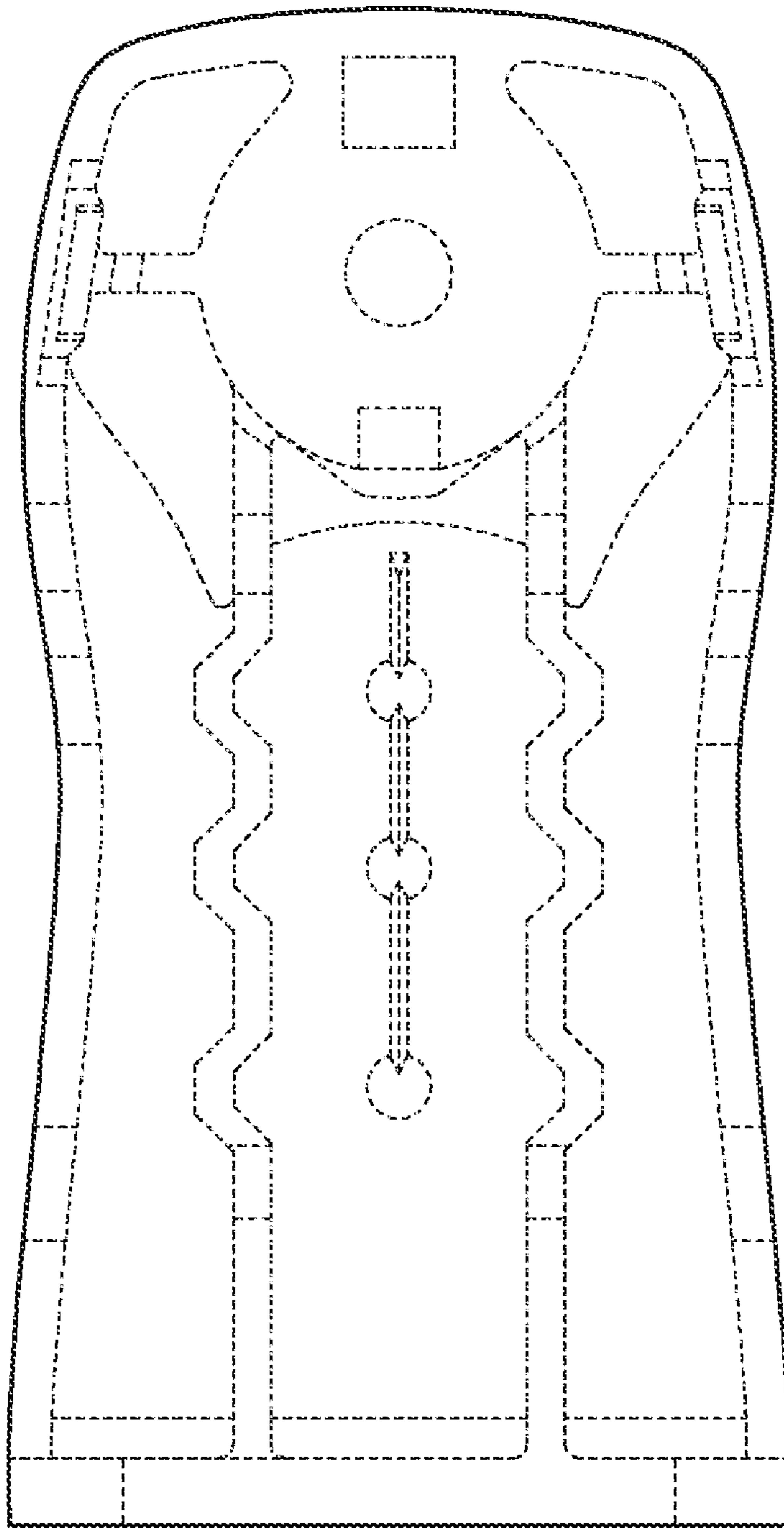
*Fig. 4*



*Fig. 5*



*Fig. 6*



*Fig. 7*