



US00D606302S

(12) **United States Design Patent**
Fahrendorff et al.

(10) **Patent No.:** **US D606,302 S**

(45) **Date of Patent:** **** Dec. 22, 2009**

(54) **HANDHELD ELECTRONIC DEVICE CASE**

D534,720 S * 1/2007 Infanti et al. D3/218
D594,226 S * 6/2009 Hofer et al. D3/218

(75) Inventors: **Anders Fahrendorff**, Ottawa (CA);
Seyed-Payam Shalchian, Ottawa (CA);
Gabriel Deen Khan, Waterloo (CA)

* cited by examiner

Primary Examiner—Catherine R Oliver

(73) Assignee: **Research In Motion Limited**, Waterloo (CA)

(57) **CLAIM**

(**) Term: **14 Years**

We claim the ornamental design for a handheld electronic device case, as shown and described.

(21) Appl. No.: **29/338,801**

DESCRIPTION

(22) Filed: **Jun. 18, 2009**

FIG. 1 is a front perspective view of a handheld electronic device case;

(51) **LOC (9) Cl.** **03-01**

(52) **U.S. Cl.** **D3/218**

(58) **Field of Classification Search** D3/218,
D3/215, 219, 224, 226, 201, 205, 269; 224/240–241,
224/901, 904, 676–681, 674, 578; D14/250–251,
D14/138; 206/305, 320; 455/42, 90, 92;
379/455

FIG. 2 is a rear perspective view of the handheld electronic device case;

FIG. 3 is a rear elevational view thereof;

FIG. 4 is a front elevational view thereof;

FIG. 5 is a left elevational view thereof;

FIG. 6 is a right elevational view thereof;

FIG. 7 is a top plan view thereof; and,

FIG. 8 is a bottom plan view thereof.

See application file for complete search history.

(56) **References Cited**

U.S. PATENT DOCUMENTS

D533,341 S * 12/2006 Infanti et al. D3/218

1 Claim, 5 Drawing Sheets

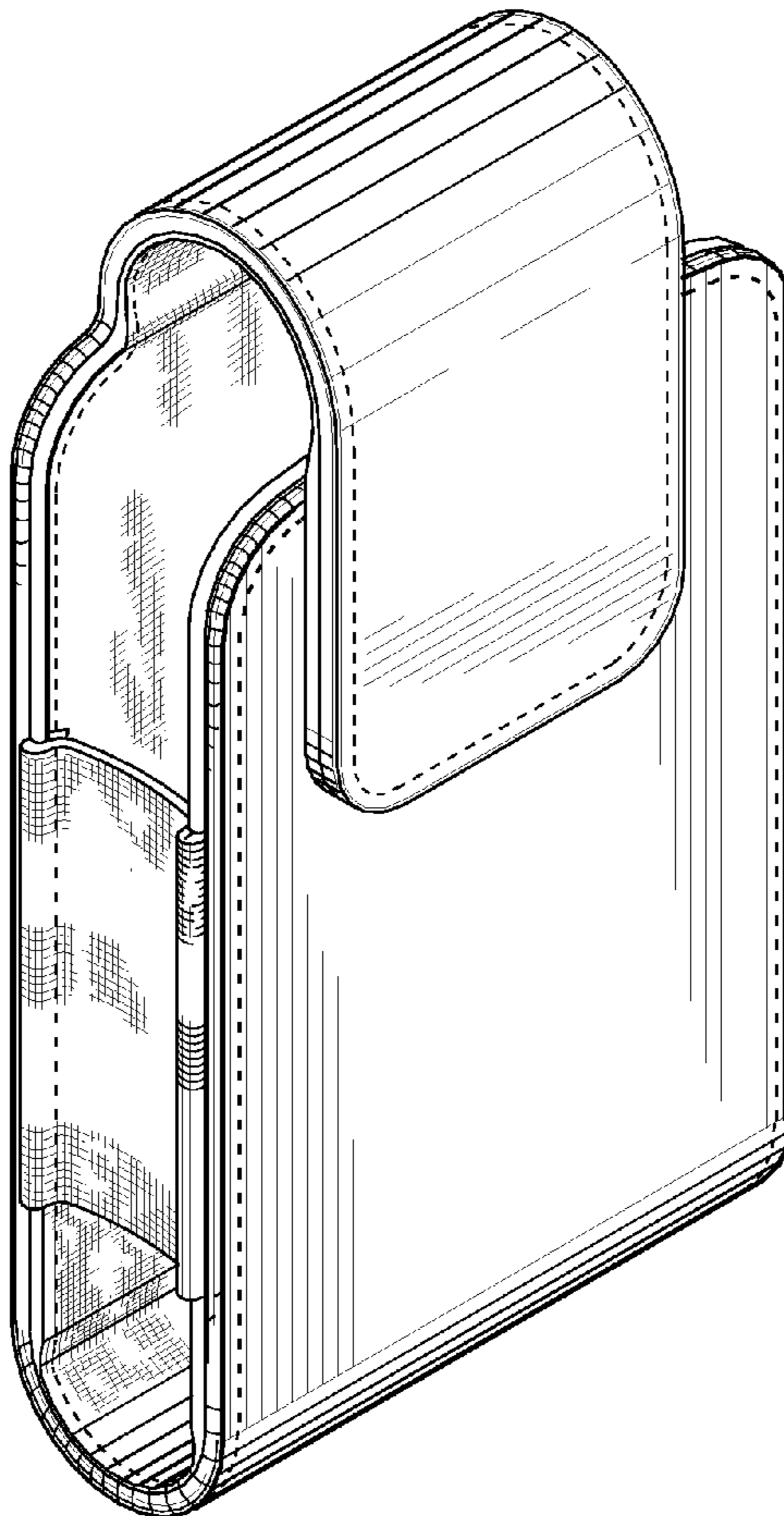

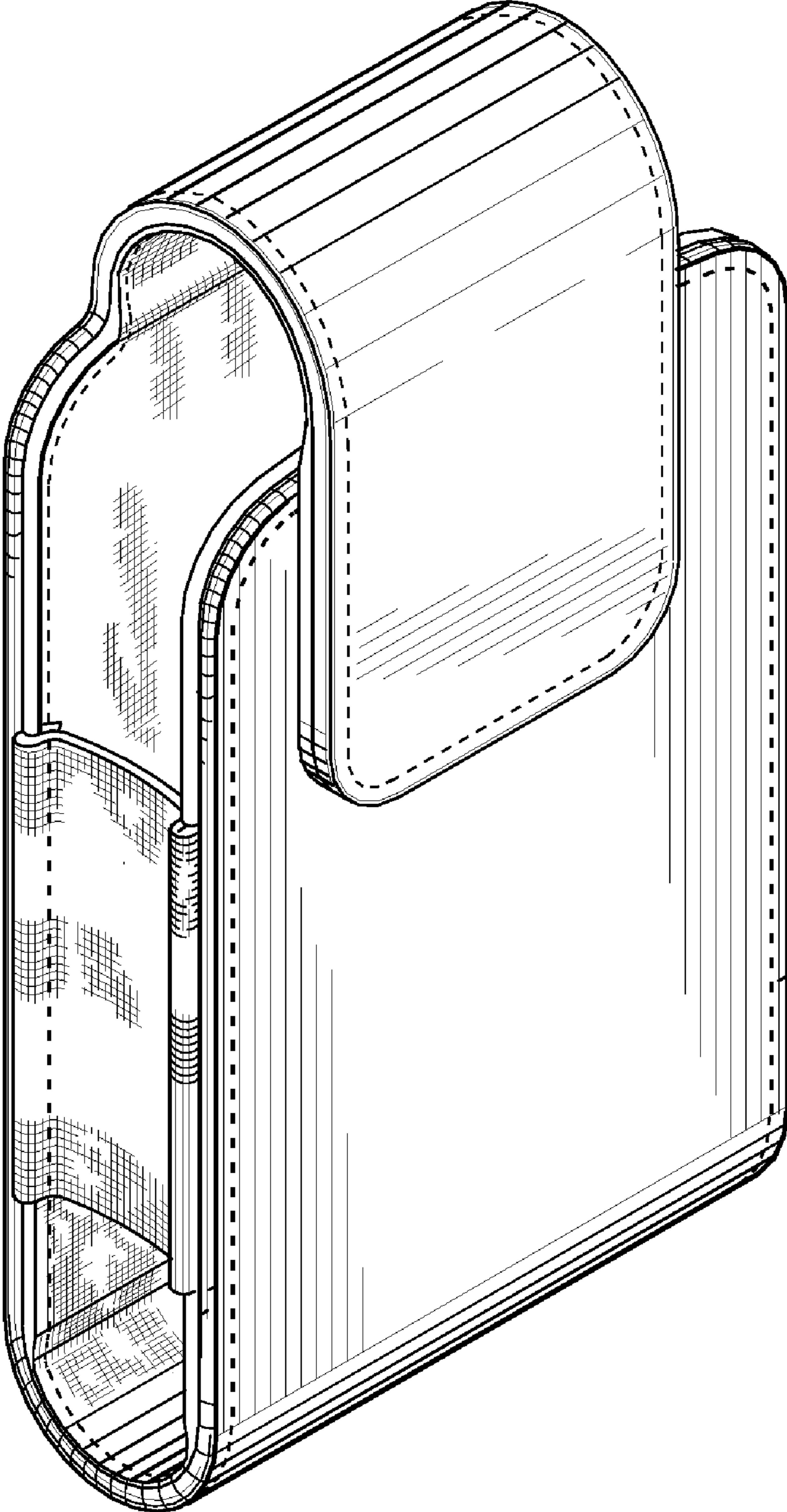

FIG.1

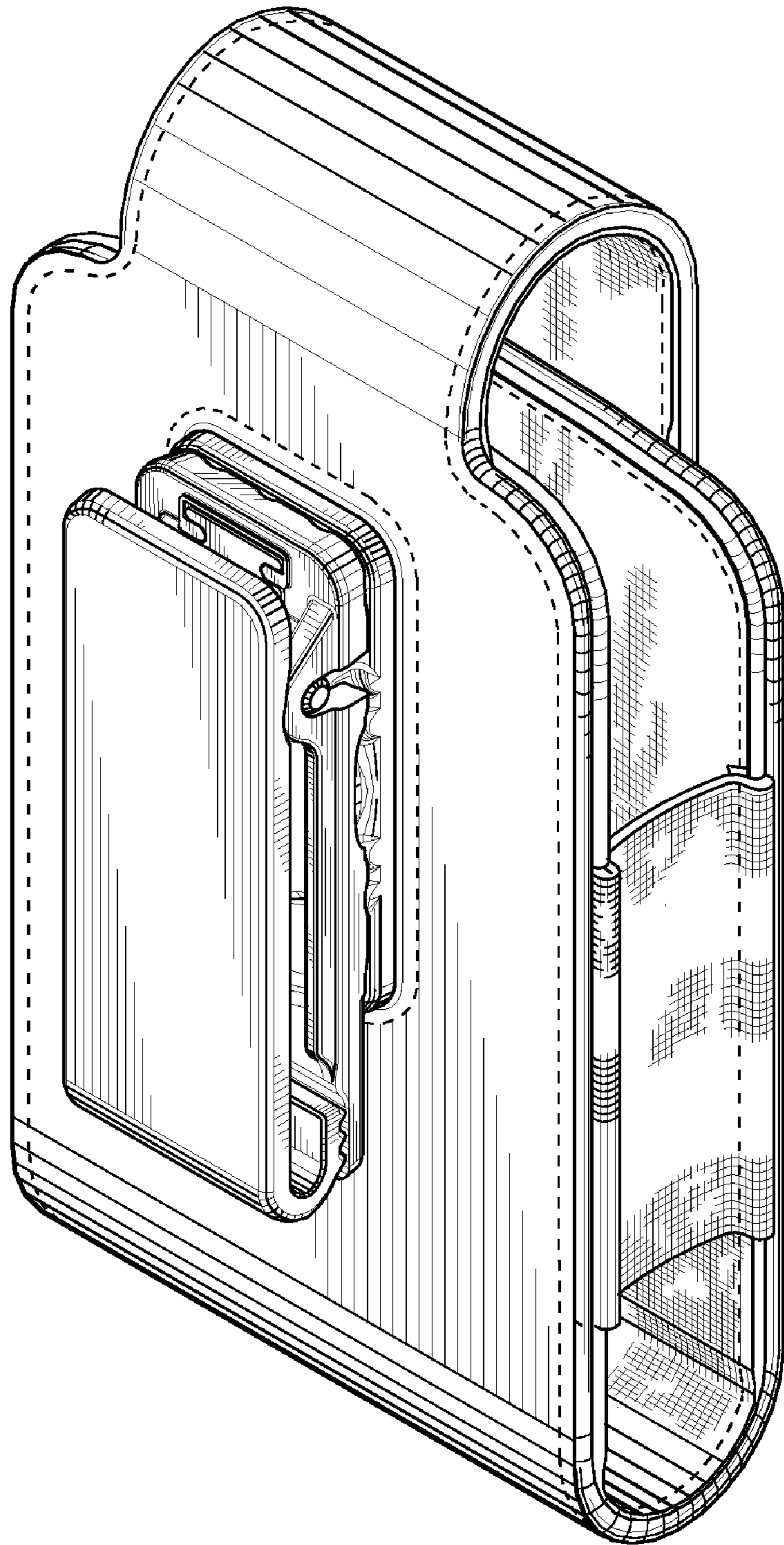

FIG.2

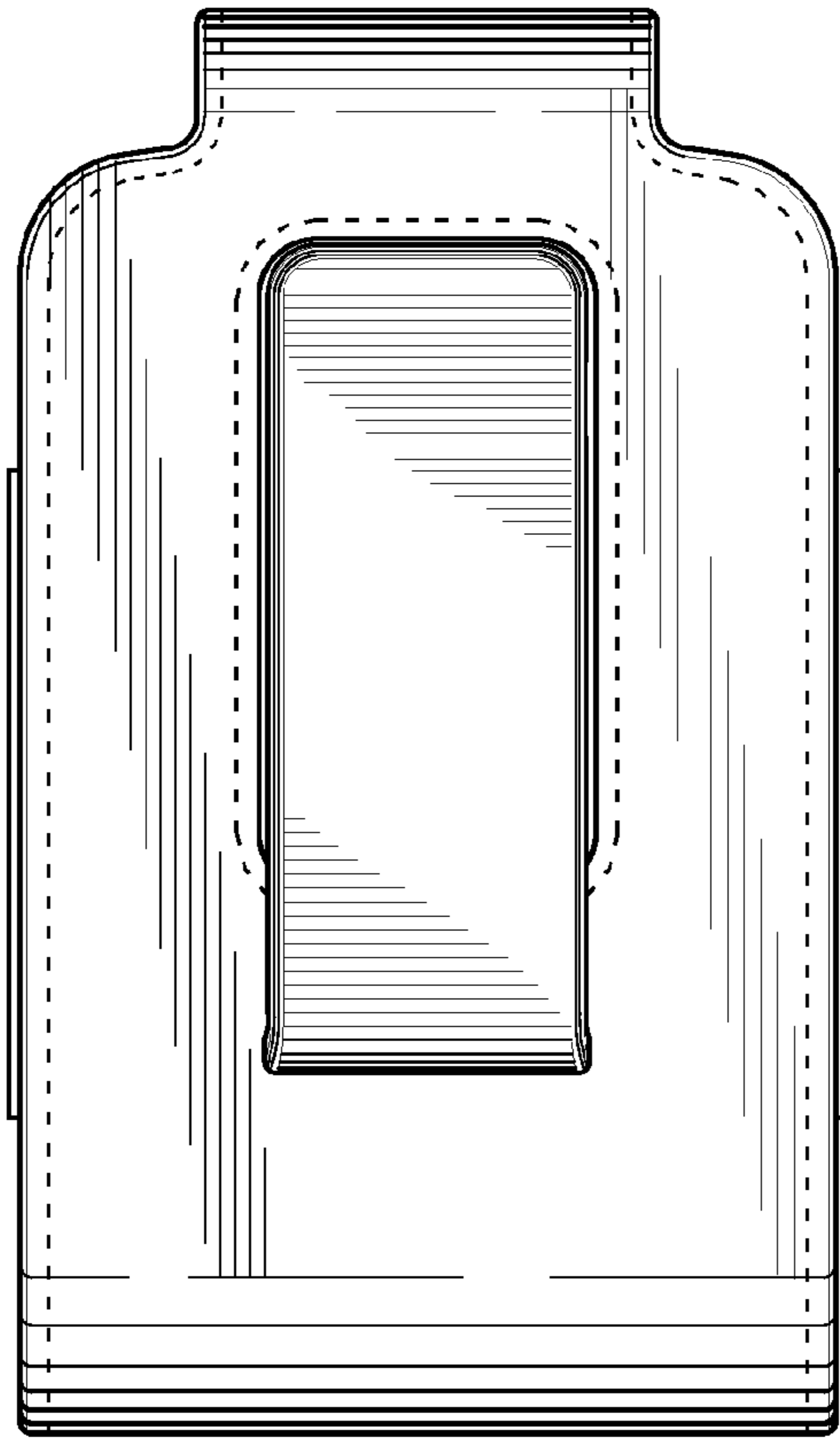

FIG.3

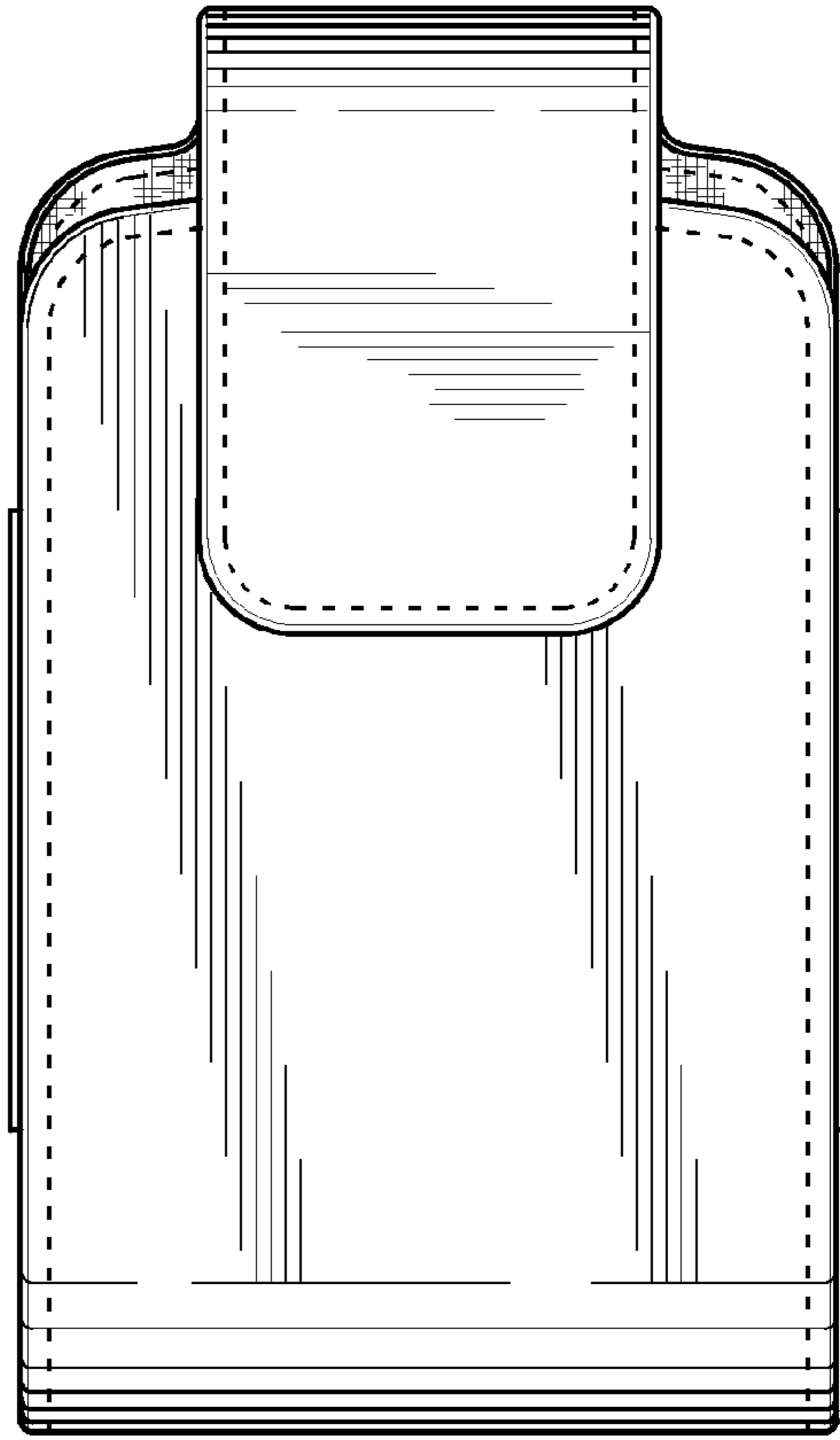

FIG.4

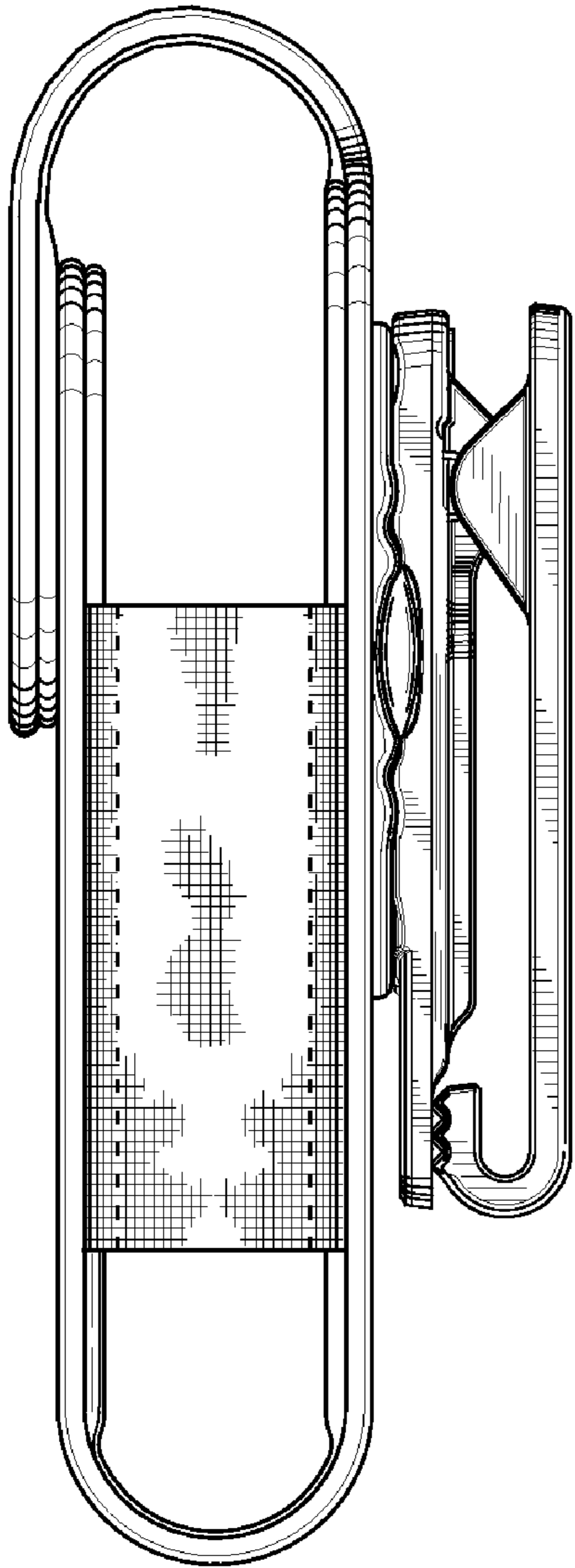

FIG. 5

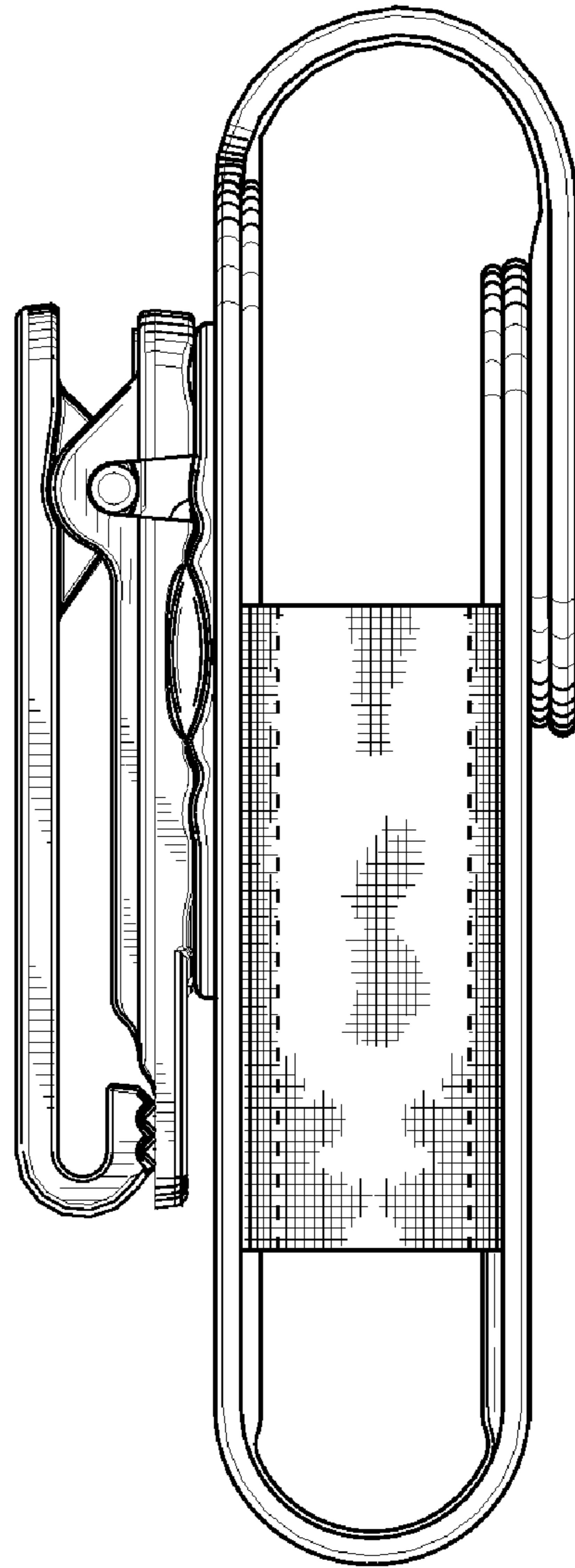

FIG. 6

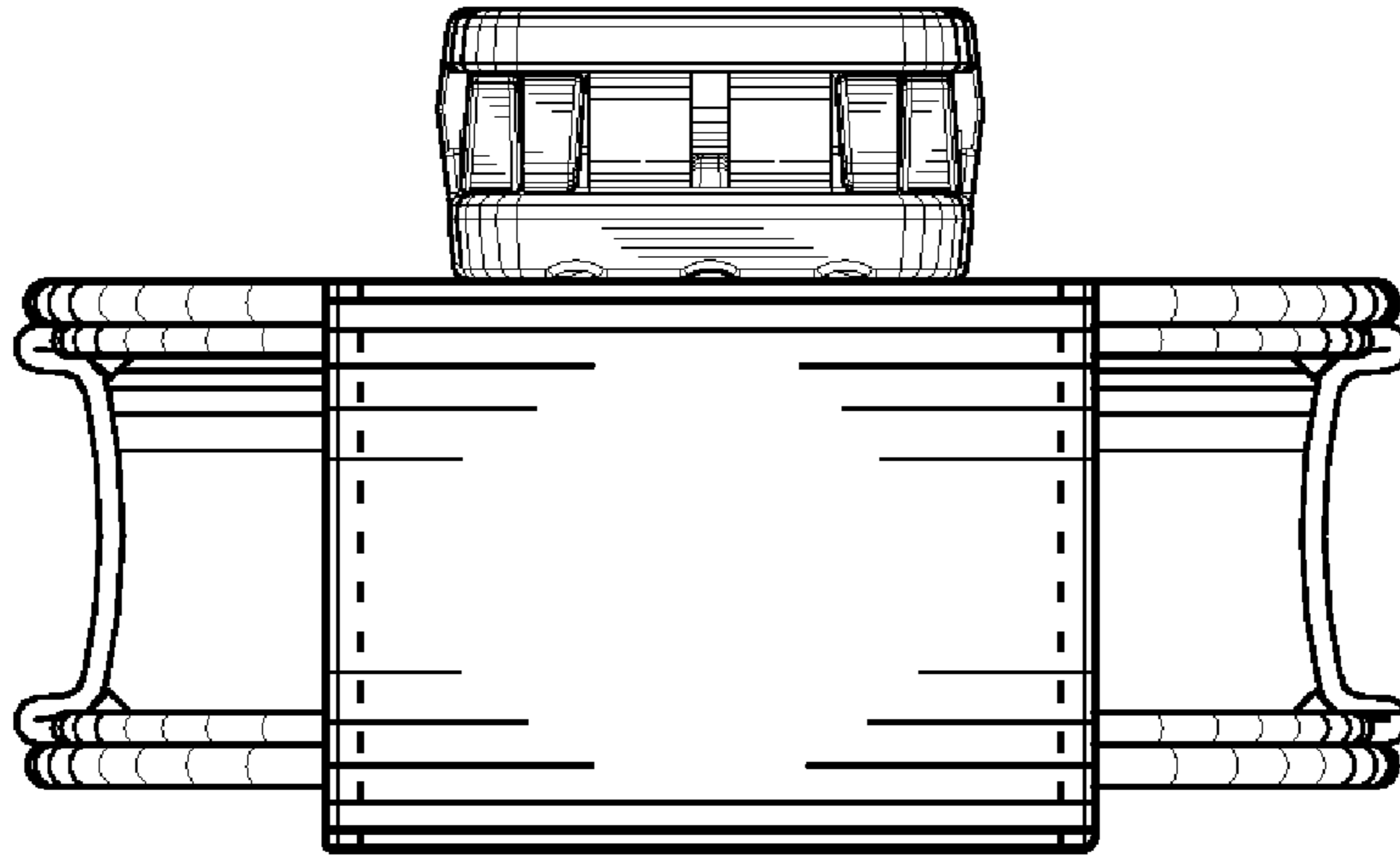

FIG. 7

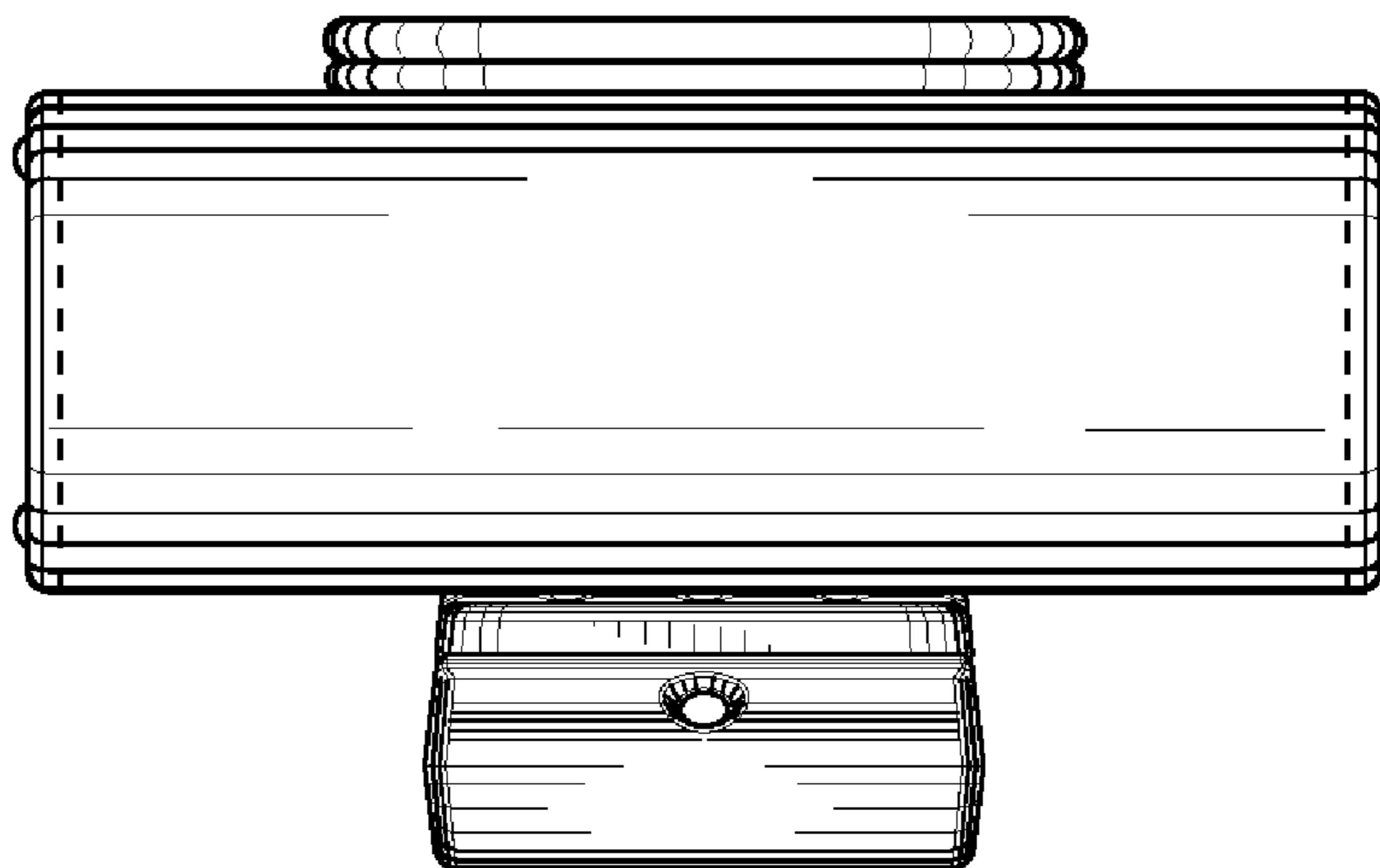

FIG. 8