



US00D606260S

(12) **United States Design Patent**
Carlucci et al.

(10) **Patent No.:** **US D606,260 S**
(45) **Date of Patent:** **** Dec. 15, 2009**

(54) **TRIMMER**

(75) Inventors: **Vito James Carlucci**, Stratford, CT (US); **Harold Roy Taylor**, Hatboro, PA (US)

(73) Assignee: **Conair Corporation**, Stamford, CT (US)

(**) Term: **14 Years**

(21) Appl. No.: **29/337,615**

(22) Filed: **May 27, 2009**

(51) **LOC (9) Cl.** **28-03**

(52) **U.S. Cl.** **D28/53**

(58) **Field of Classification Search** D28/44,
D28/44.1, 49-54; 30/32, 34.05, 34.1-34.2,
30/43-43.92, 44-45, 47-50, 537; 606/131,
606/133

See application file for complete search history.

(56) **References Cited**

U.S. PATENT DOCUMENTS

- D379,012 S * 4/1997 van Asten D28/51
- D400,302 S * 10/1998 Ullmann D28/49
- D401,013 S * 11/1998 Ullmann D28/49
- D517,730 S * 3/2006 Bauwens D28/53
- D537,206 S * 2/2007 Ullmann D28/49

D592,805 S * 5/2009 Refior D28/51

* cited by examiner

Primary Examiner—Jennifer Rivard

(74) *Attorney, Agent, or Firm*—Lawrence Cruz

(57) **CLAIM**

We claim the ornamental design for the trimmer, as shown and described.

DESCRIPTION

FIG. 1 is a perspective view of a trimmer shown in an open configuration;

FIG. 2 is a left side view of the trimmer shown in a closed configuration;

FIG. 3 is a top view thereof;

FIG. 4 is a bottom view thereof;

FIG. 5 is an end view thereof;

FIG. 6 is an opposite end view thereof;

FIG. 7 is a left side view of the trimmer shown in an open configuration;

FIG. 8 is a top view thereof;

FIG. 9 is a bottom view thereof;

FIG. 10 is an end view thereof; and,

FIG. 11 is an opposite end view thereof.

The right side views of the trimmer are mirror images of the respective left side views.

1 Claim, 5 Drawing Sheets

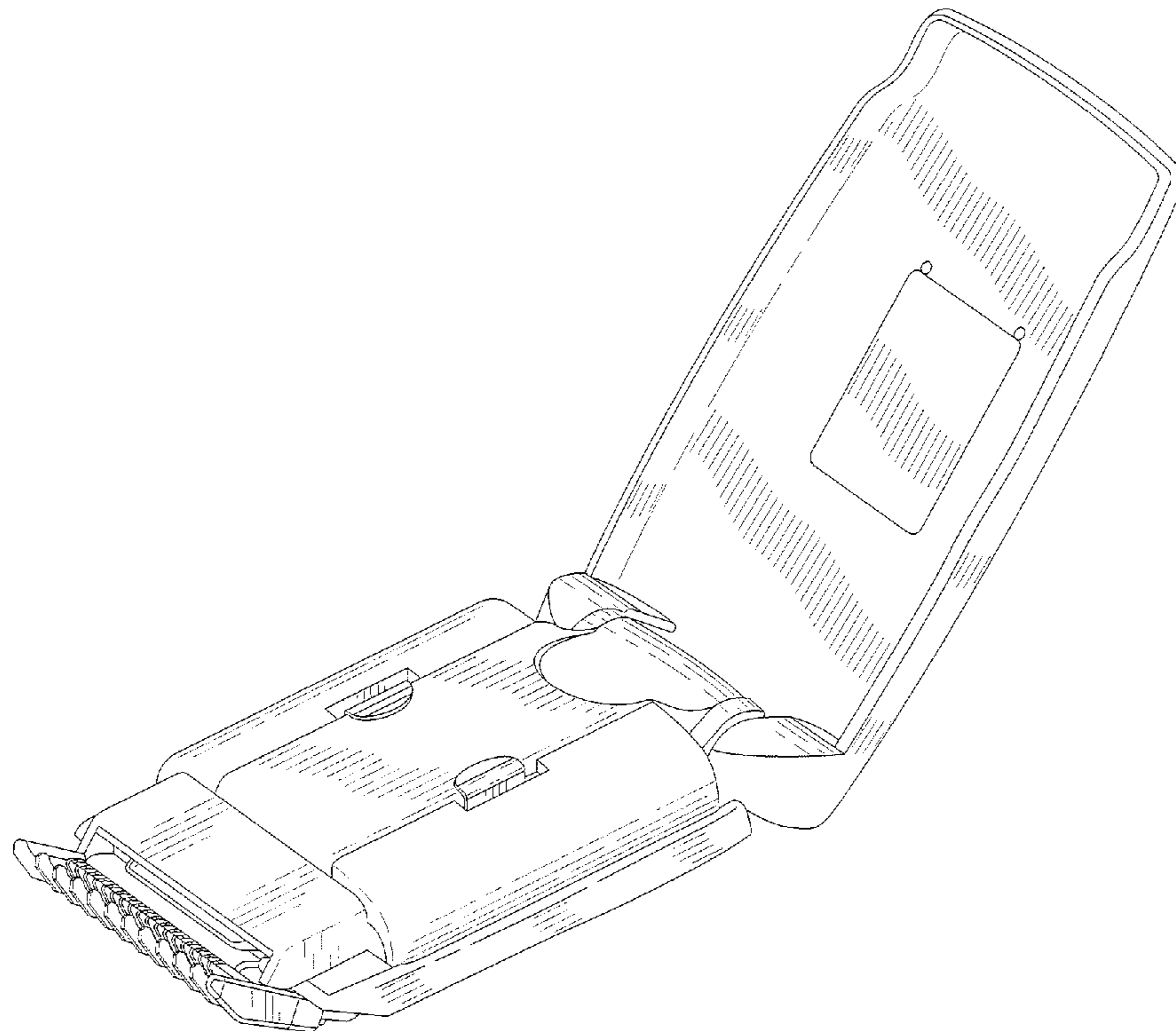

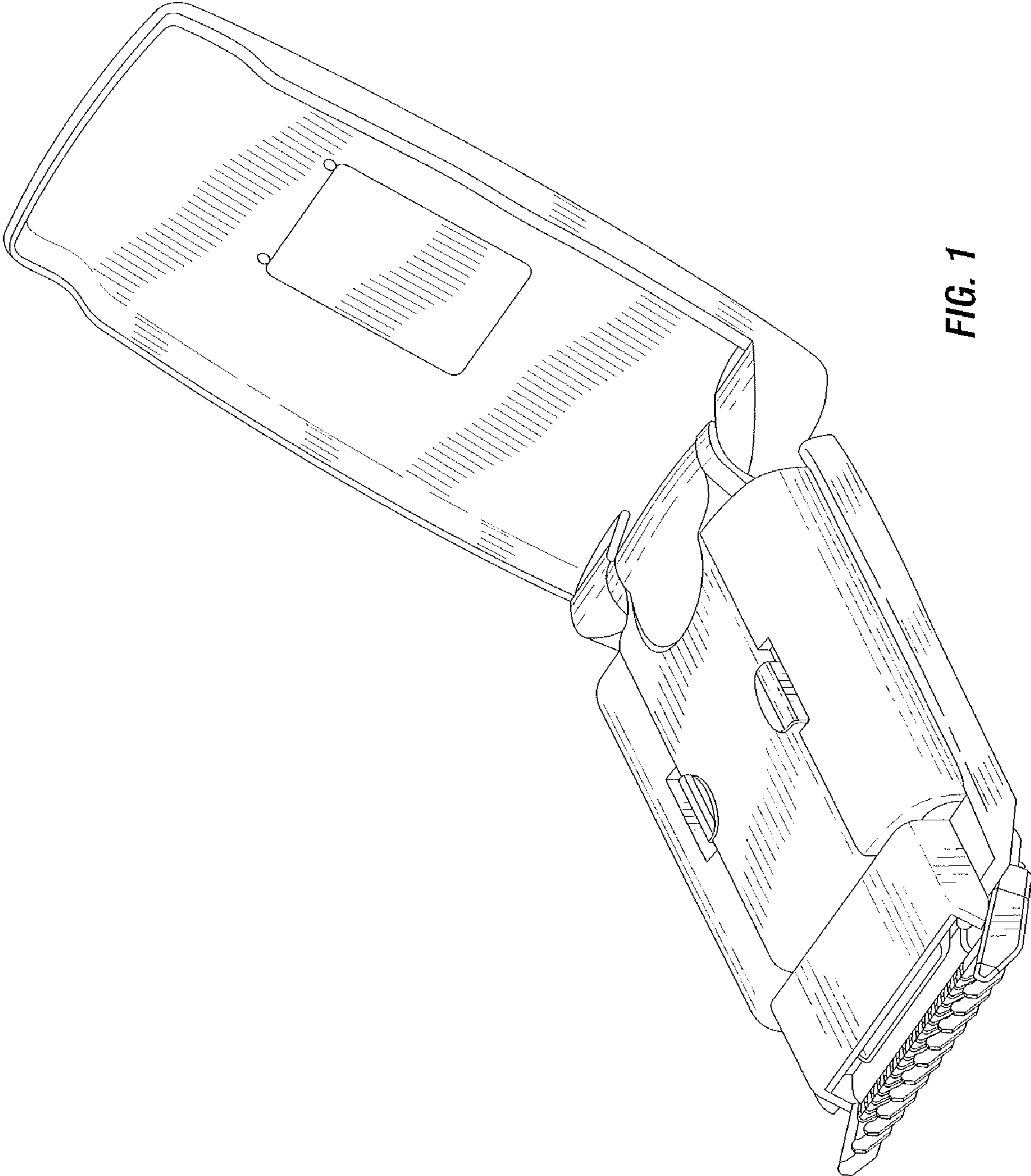

FIG. 1

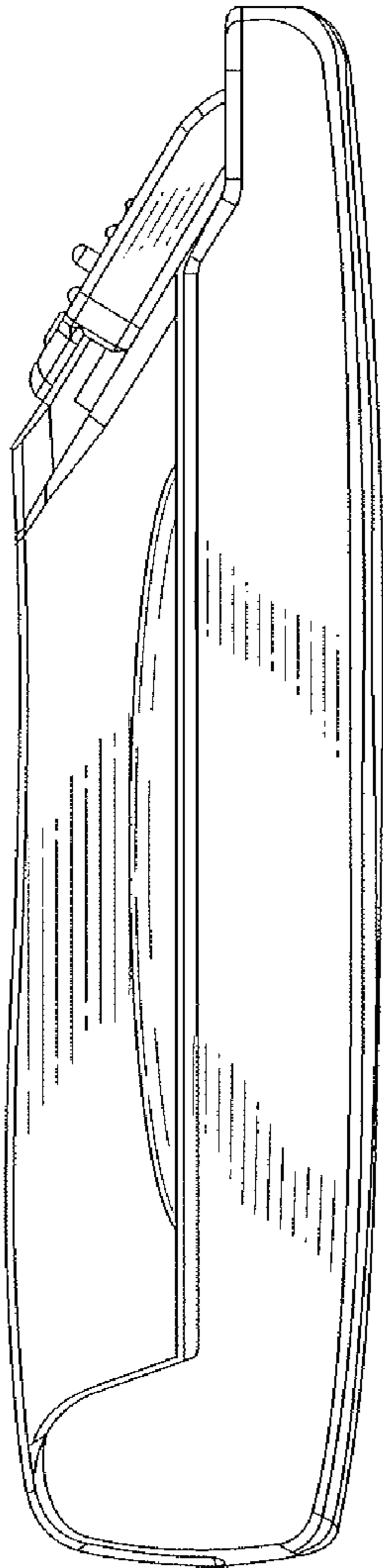

FIG. 2

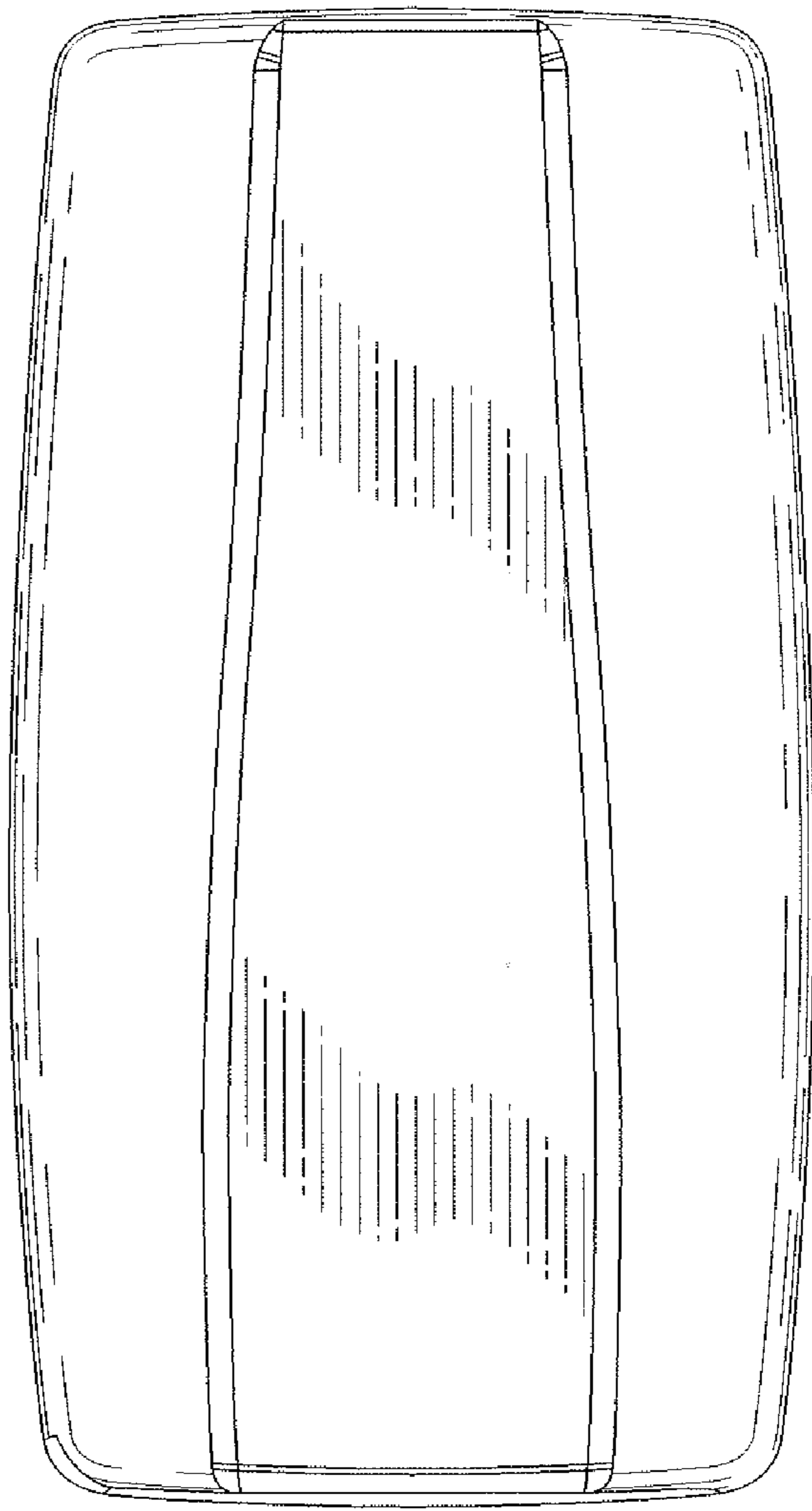

FIG. 3

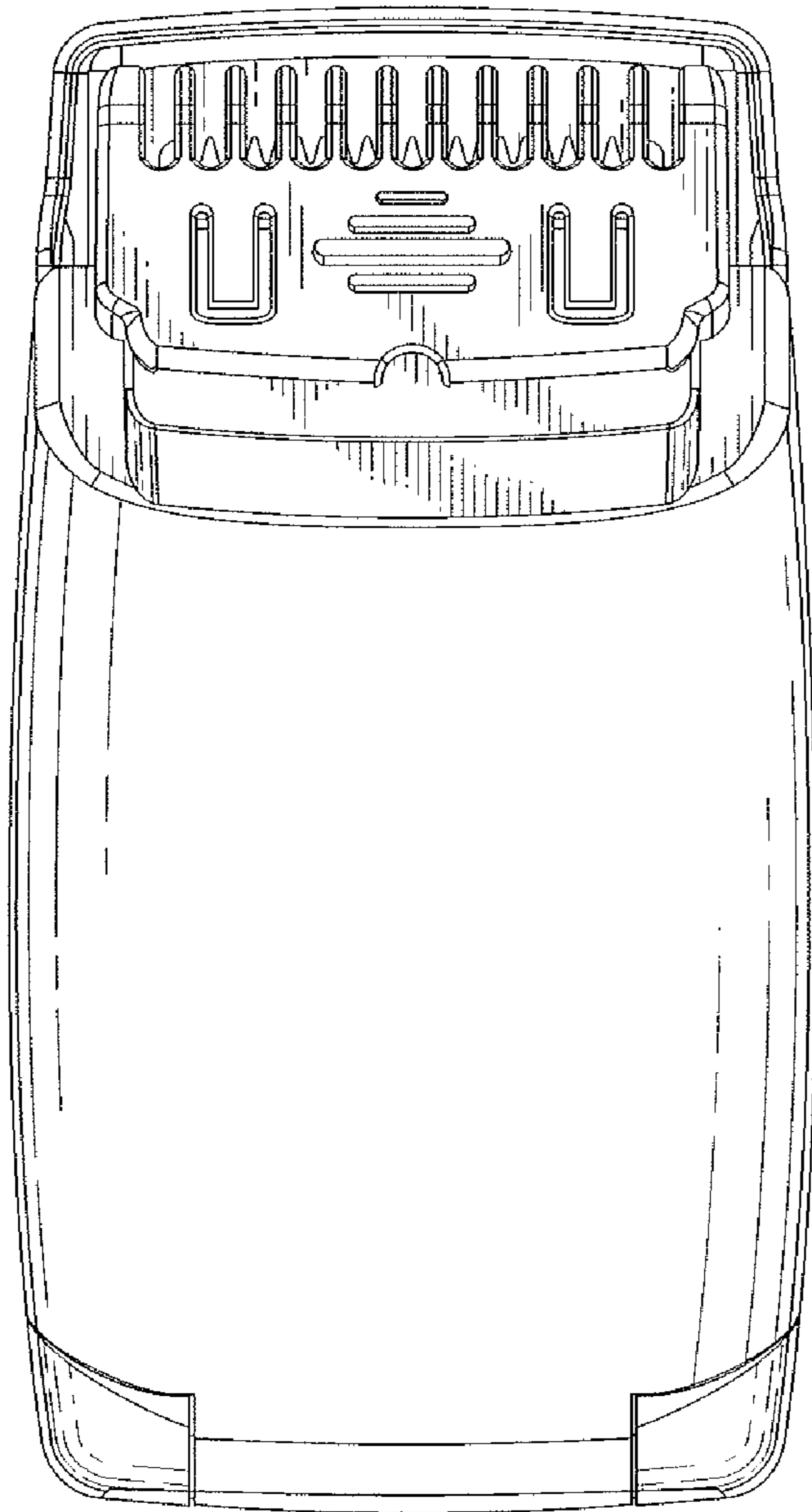

FIG. 4

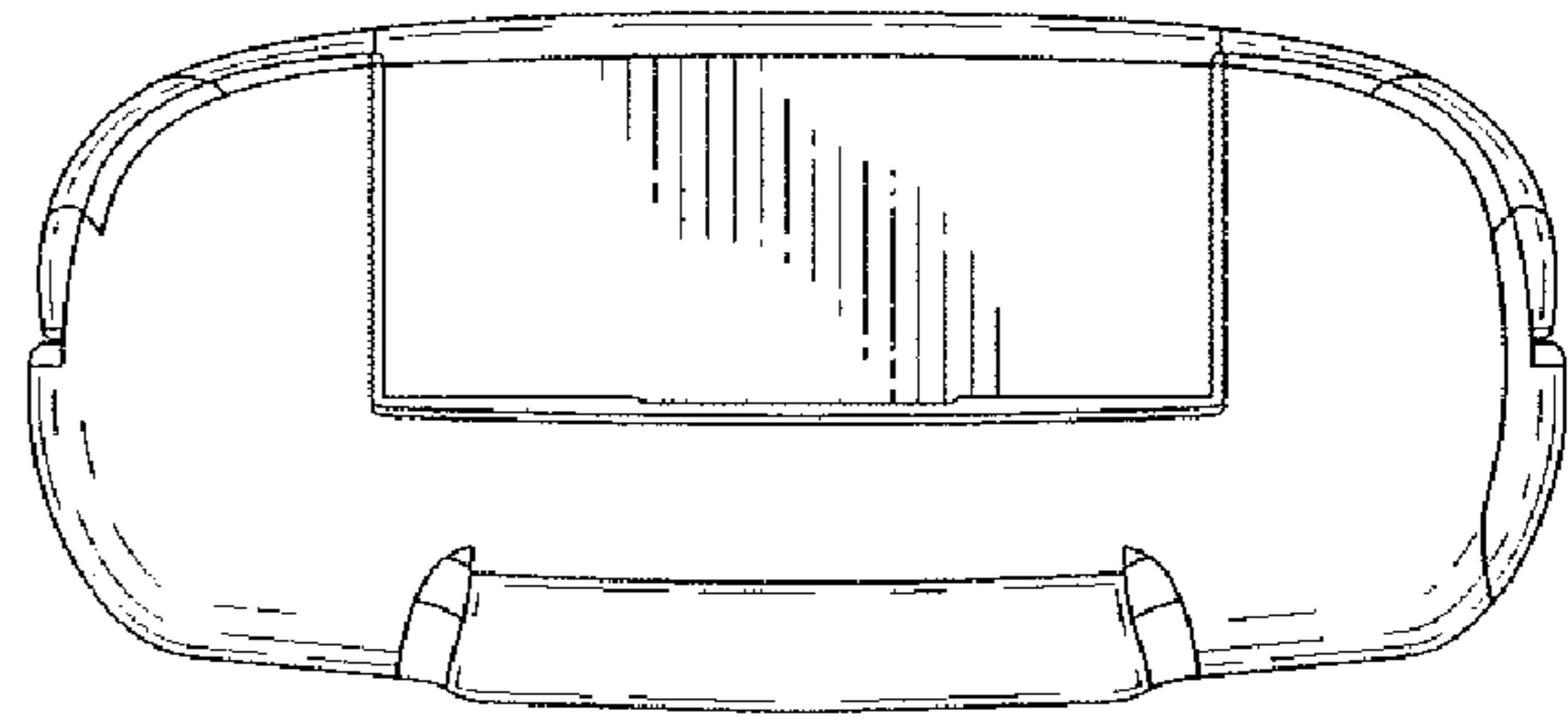

FIG. 5

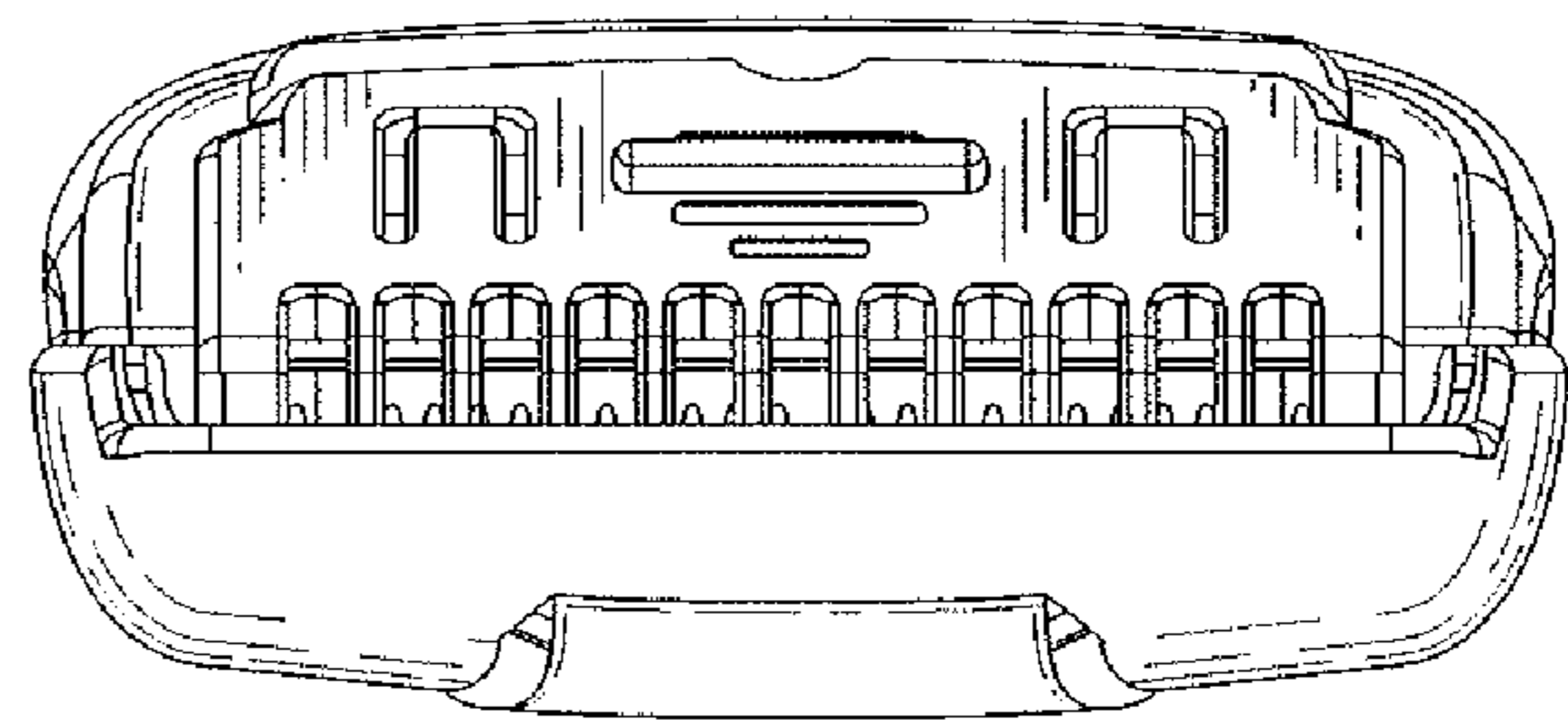

FIG. 6

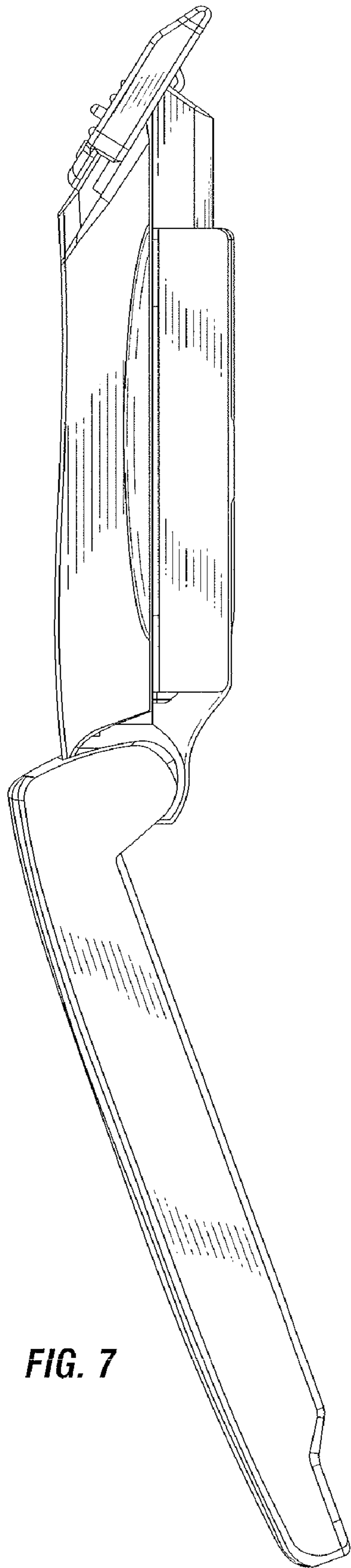

FIG. 7

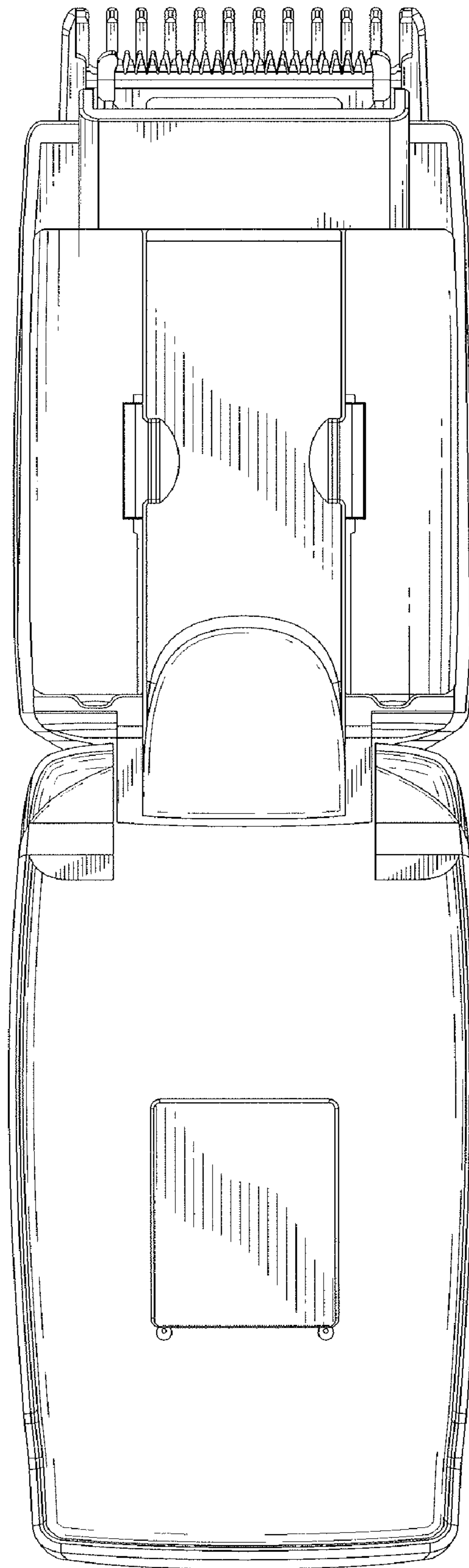

FIG. 8

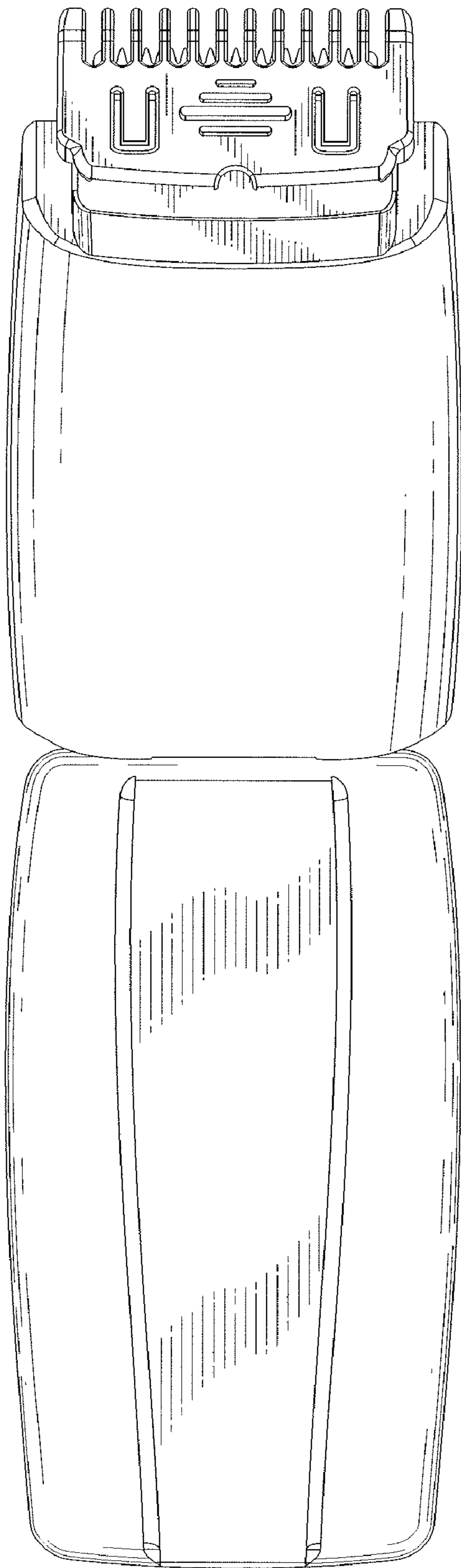

FIG. 9

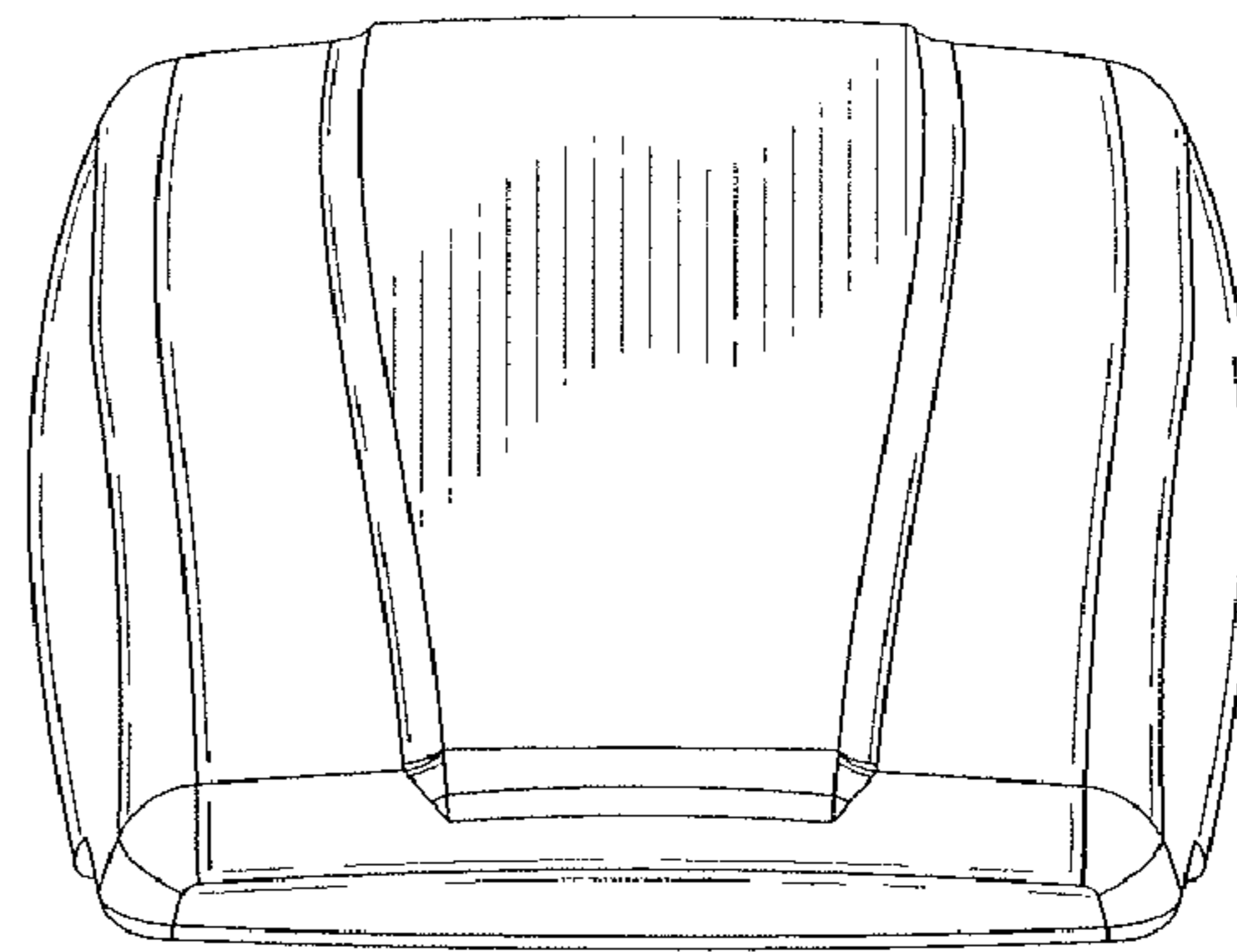

FIG. 10

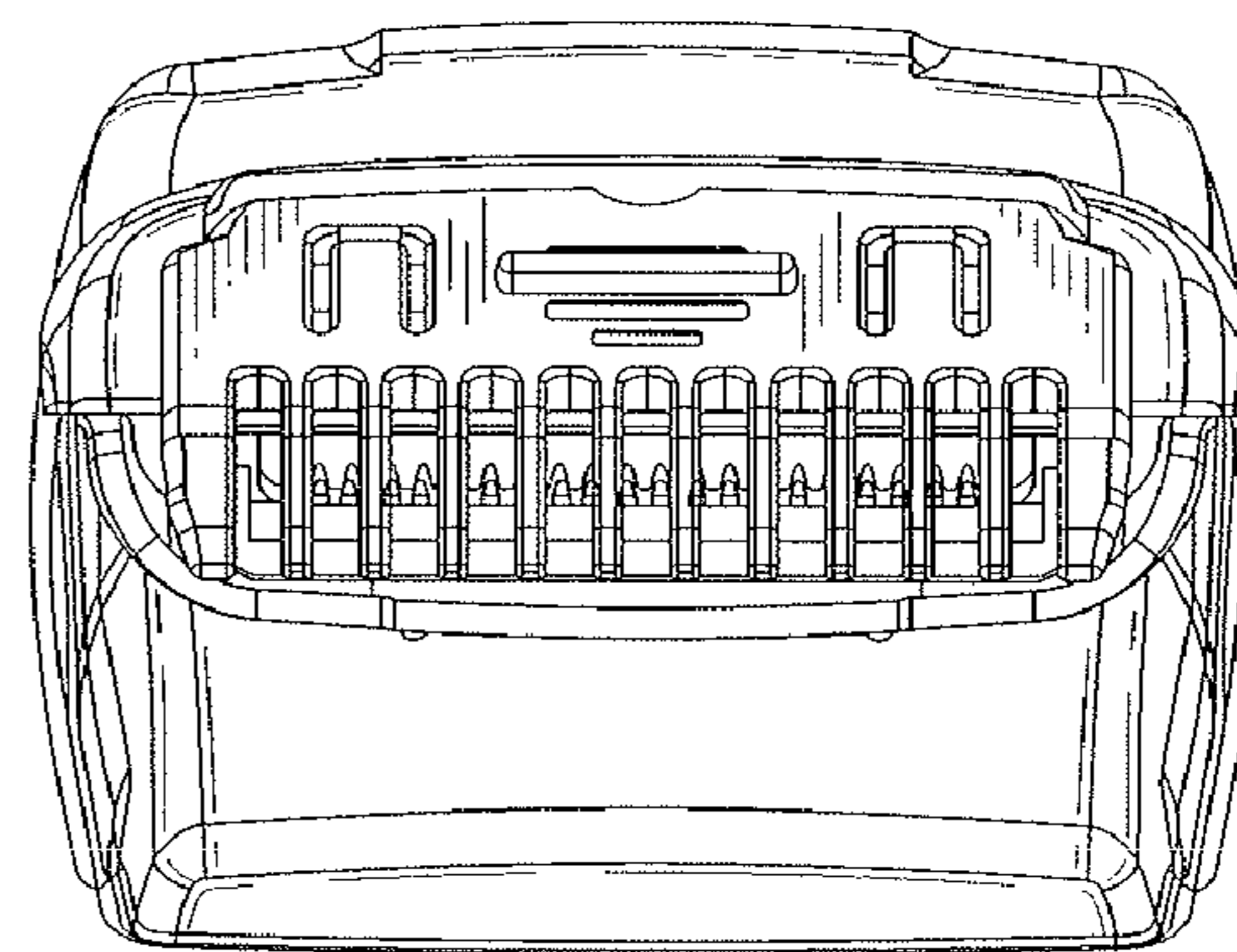

FIG. 11