



US00D606247S

(12) **United States Design Patent**  
**Yu et al.**

(10) **Patent No.:** **US D606,247 S**  
(45) **Date of Patent:** **\*\* Dec. 15, 2009**

(54) **HAIR DRYER**

(75) Inventors: **King Kuen Yu**, New Territories (HK);  
**Kin Sun Kwok**, New Territories (HK)

(73) Assignee: **Kenford Industrial Co. Ltd.**, New Territories (HK)

(\*\*) Term: **14 Years**

(21) Appl. No.: **29/332,127**

(22) Filed: **Feb. 9, 2009**

(51) **LOC (9) Cl.** ..... **28-03**

(52) **U.S. Cl.** ..... **D28/13**

(58) **Field of Classification Search** ..... D28/12-19;  
34/96-101; 392/380-385; 219/222  
See application file for complete search history.

(56) **References Cited**

**U.S. PATENT DOCUMENTS**

D412,219 S *	7/1999	Goetschi	.....	D28/13
D456,943 S *	5/2002	Micinilio et al.	.....	D28/13
D470,975 S *	2/2003	Rizzuto, Jr.	.....	D28/13
D470,976 S *	2/2003	Rizzuto, Jr.	.....	D28/13
D494,710 S *	8/2004	Parodi	.....	D28/13
D496,754 S *	9/2004	Parodi	.....	D28/13
D502,783 S *	3/2005	Yeung	.....	D28/13
D543,313 S *	5/2007	Petruccelli, Jr.	.....	D28/13

D544,147 S *	6/2007	Baudouin	.....	D28/13
D559,443 S *	1/2008	Smith et al.	.....	D28/13
D586,036 S *	2/2009	Petruccelli, Jr.	.....	D28/13

\* cited by examiner

*Primary Examiner*—Janice E Seeger

*Assistant Examiner*—Zenia I Bennett

(74) *Attorney, Agent, or Firm*—Intellectual Property Law Group LLP; Juneko Jackson; Otto O. Lee

(57) **CLAIM**

The ornamental design for a hair dryer, as shown and described.

**DESCRIPTION**

FIG. 1 is a perspective view of a hair dryer embodying our new design;

FIG. 2 is a right side elevational view thereof;

FIG. 3 is a left side elevational view thereof;

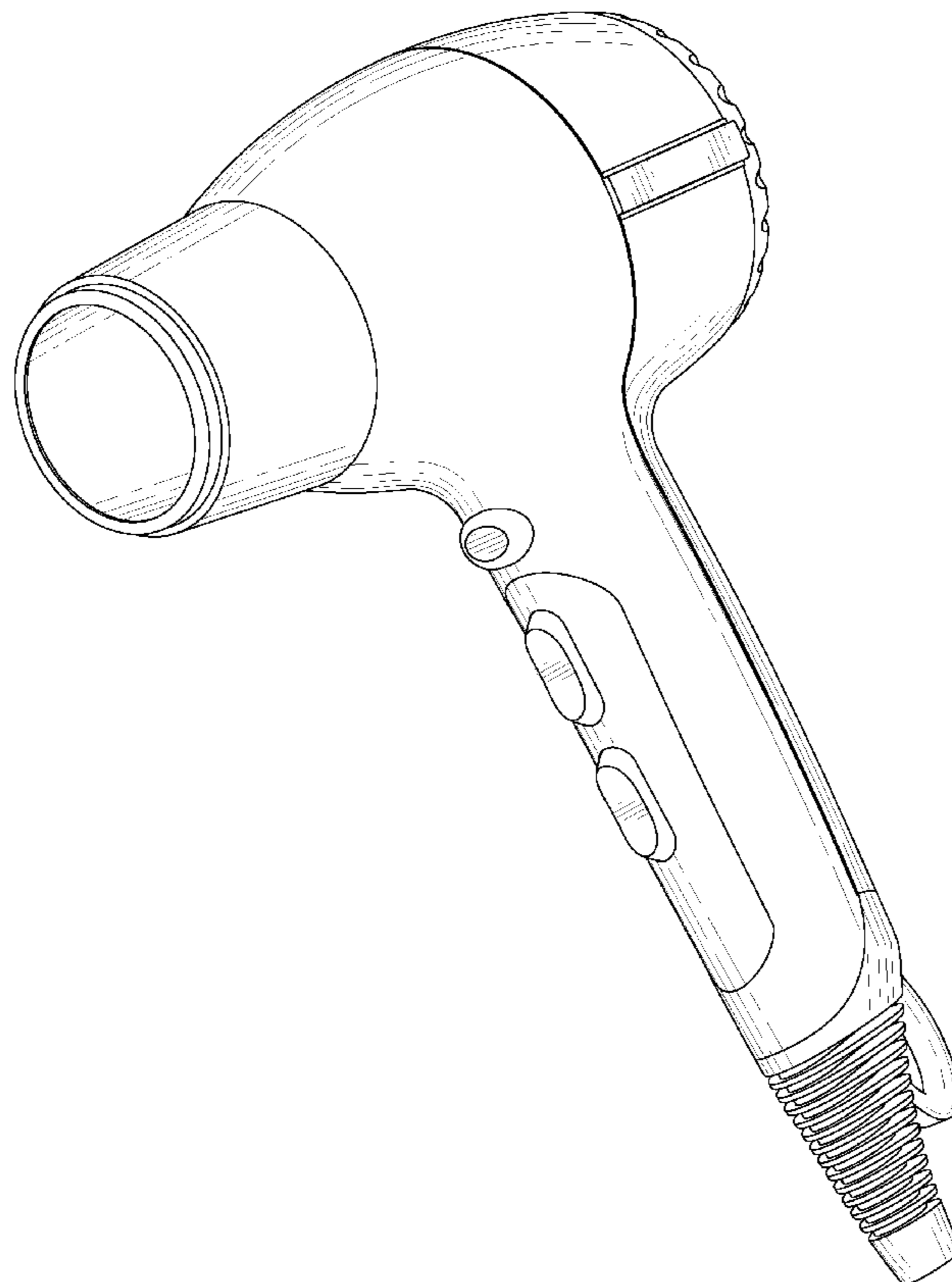
FIG. 4 is a rear elevational view thereof; the front elevational view being a mirror image thereof;

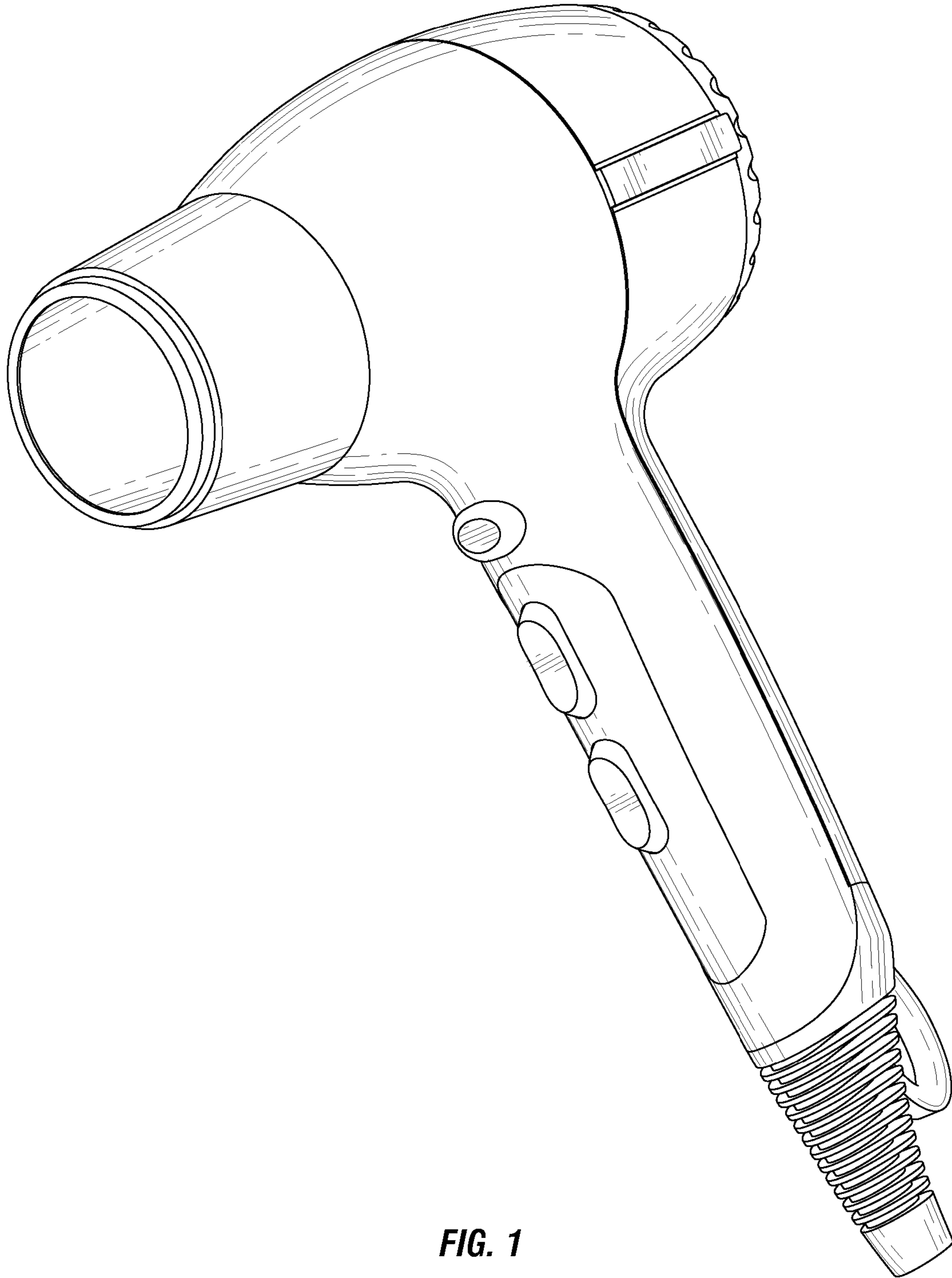
FIG. 5 is a top plan view thereof; and,

FIG. 6 is a bottom plan view thereof.

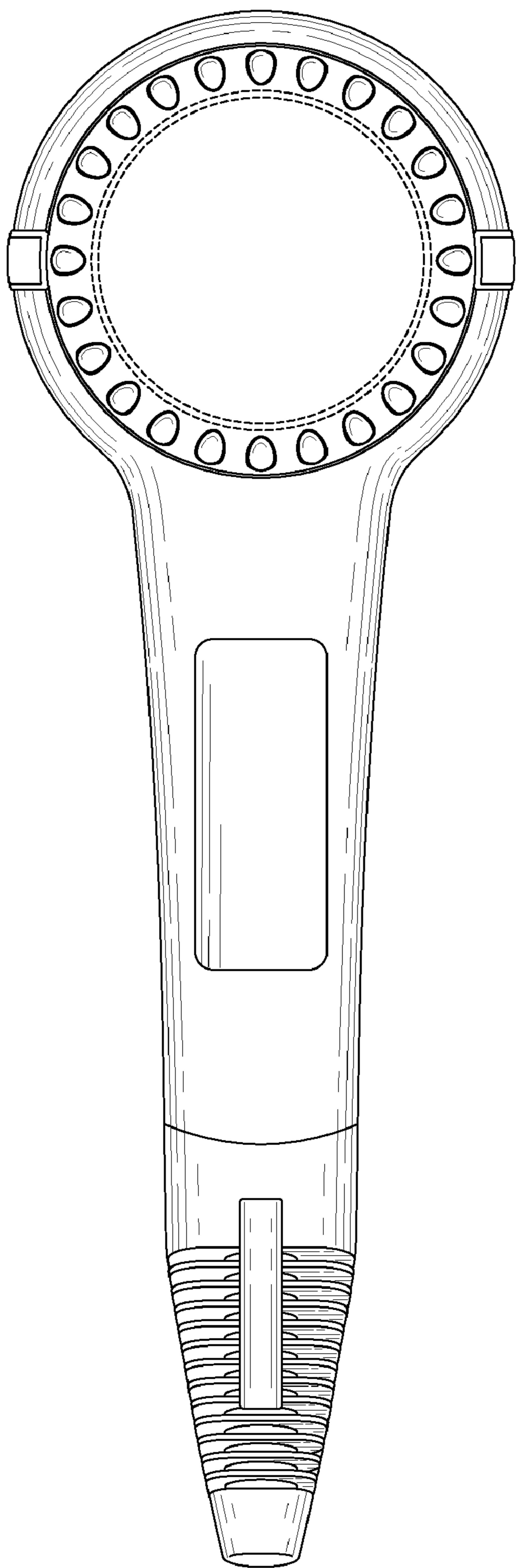
The broken lines are for environmental purposes only and form no part of the claimed design.

**1 Claim, 4 Drawing Sheets**

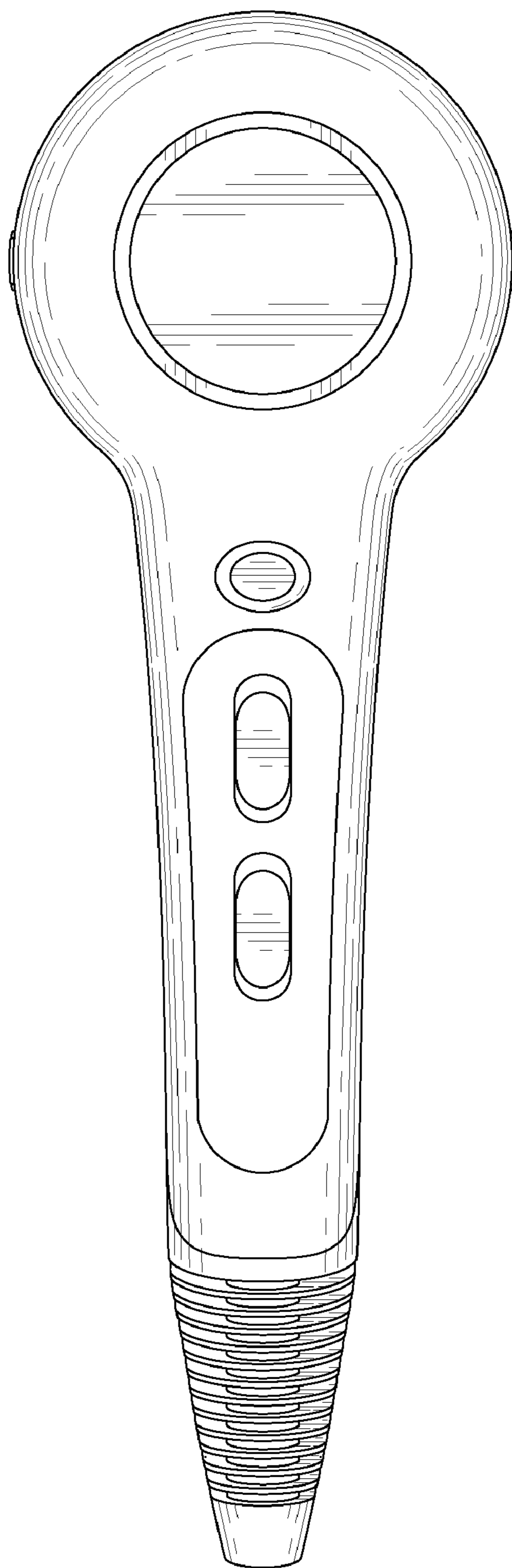




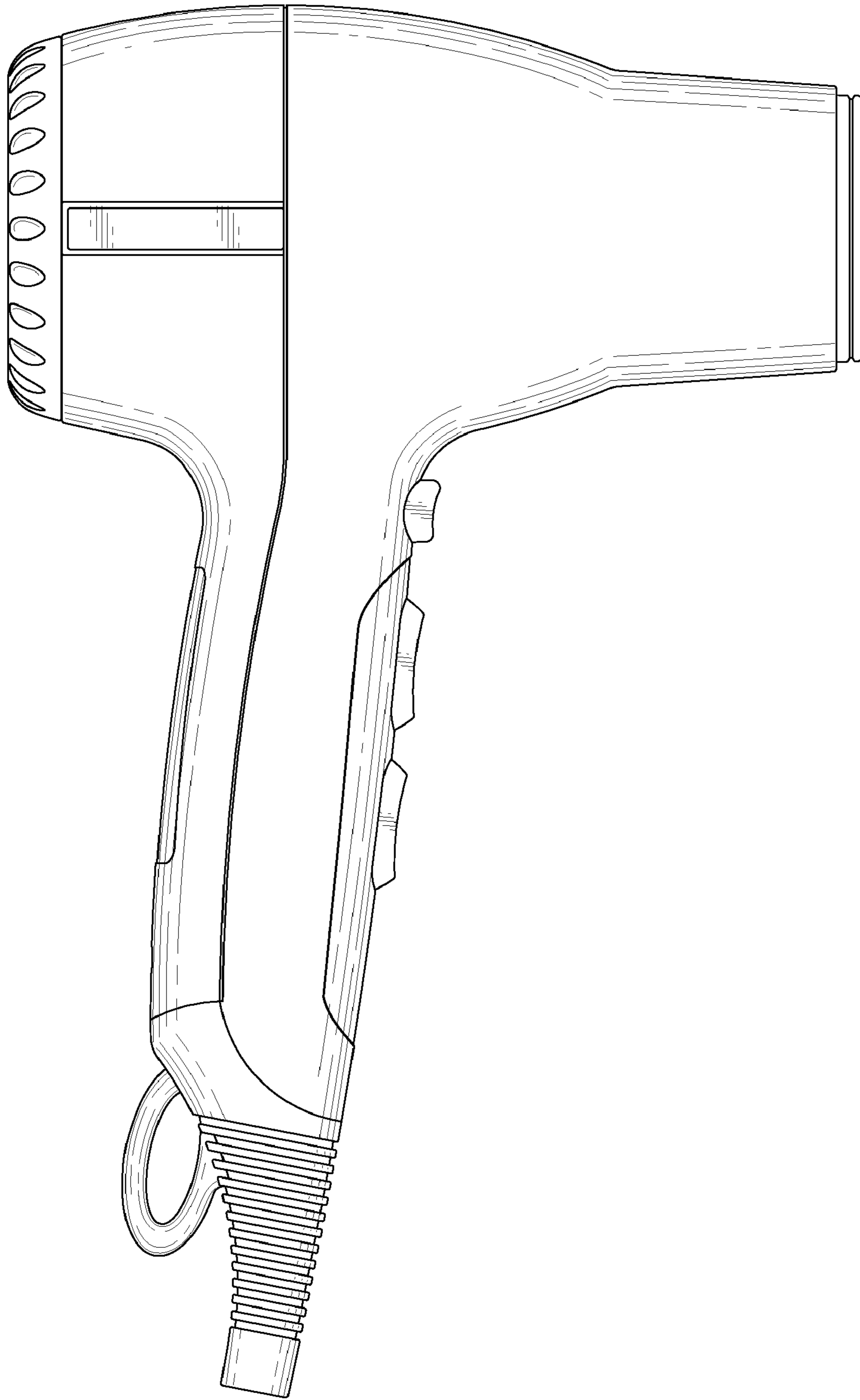
**FIG. 1**



**FIG. 2**

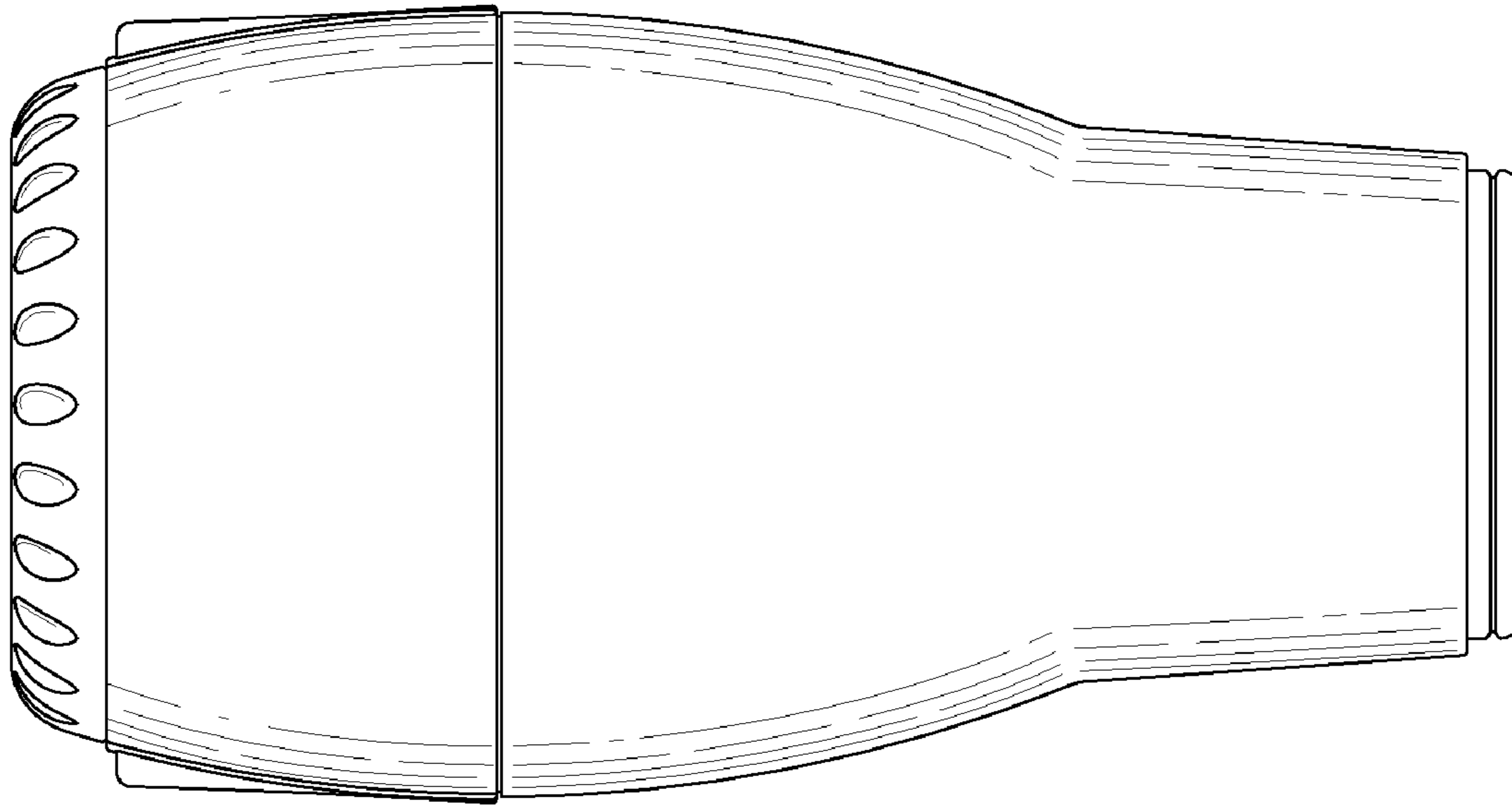


**FIG. 3**

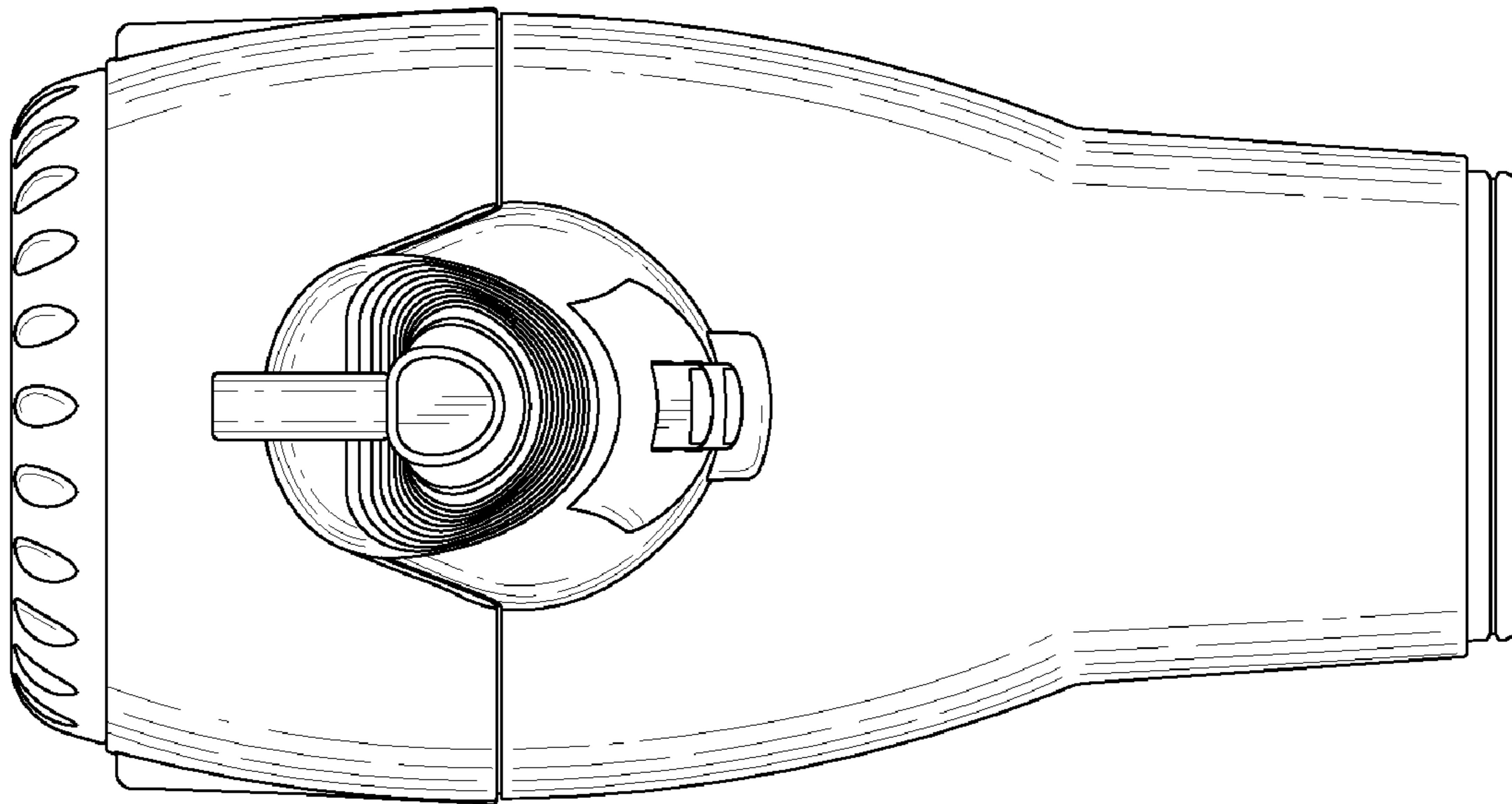


**FIG. 4**





**FIG. 5**



**FIG. 6**