



US00D606221S

(12) **United States Design Patent**
Kung

(10) **Patent No.:** **US D606,221 S**
(45) **Date of Patent:** **** Dec. 15, 2009**

(54) **FLASHLIGHT**

(75) Inventor: **Kenneth Kung**, Columbus, OH (US)

(73) Assignee: **Dorcy International Inc.**, Columbus

(**) Term: **14 Years**

(21) Appl. No.: **29/303,609**

(22) Filed: **Feb. 12, 2008**

(51) **LOC (9) Cl.** **26-02**

(52) **U.S. Cl.** **D26/49**

(58) **Field of Classification Search** D26/37,
D26/46, 48, 49, 50; 362/157, 158, 183, 184,
362/190, 194, 195, 196, 197, 202, 203–208
See application file for complete search history.

(56) **References Cited**

U.S. PATENT DOCUMENTS

D378,703 S *	4/1997	Lo	D26/46
D482,151 S *	11/2003	Shiu	D26/49
D494,298 S *	8/2004	Brent	D26/49
D494,691 S *	8/2004	Lee	D26/37
D501,267 S *	1/2005	Kung	D26/37
D504,534 S *	4/2005	Osiecki et al.	D26/49
D507,064 S *	7/2005	Osiecki et al.	D26/37

D530,031 S *	10/2006	Kung	D26/37
D544,118 S *	6/2007	Osiecki et al.	D26/37
D552,776 S *	10/2007	Osiecki et al.	D26/49

* cited by examiner

Primary Examiner—Ian Simmons
Assistant Examiner—Carissa C Fitts

(57) **CLAIM**

The ornamental design for a flashlight, as shown and described.

DESCRIPTION

FIG. 1 is a front elevational view of a flashlight showing my new design;

FIG. 2 is a rear elevational view thereof;

FIG. 3 is a left side view thereof;

FIG. 4 is a right side view thereof;

FIG. 5 is a top plan view thereof;

FIG. 6 is a bottom plan view thereof; and,

FIG. 7 is a perspective view thereof.

The broken lines shown form no part of the claimed design.

1 Claim, 4 Drawing Sheets

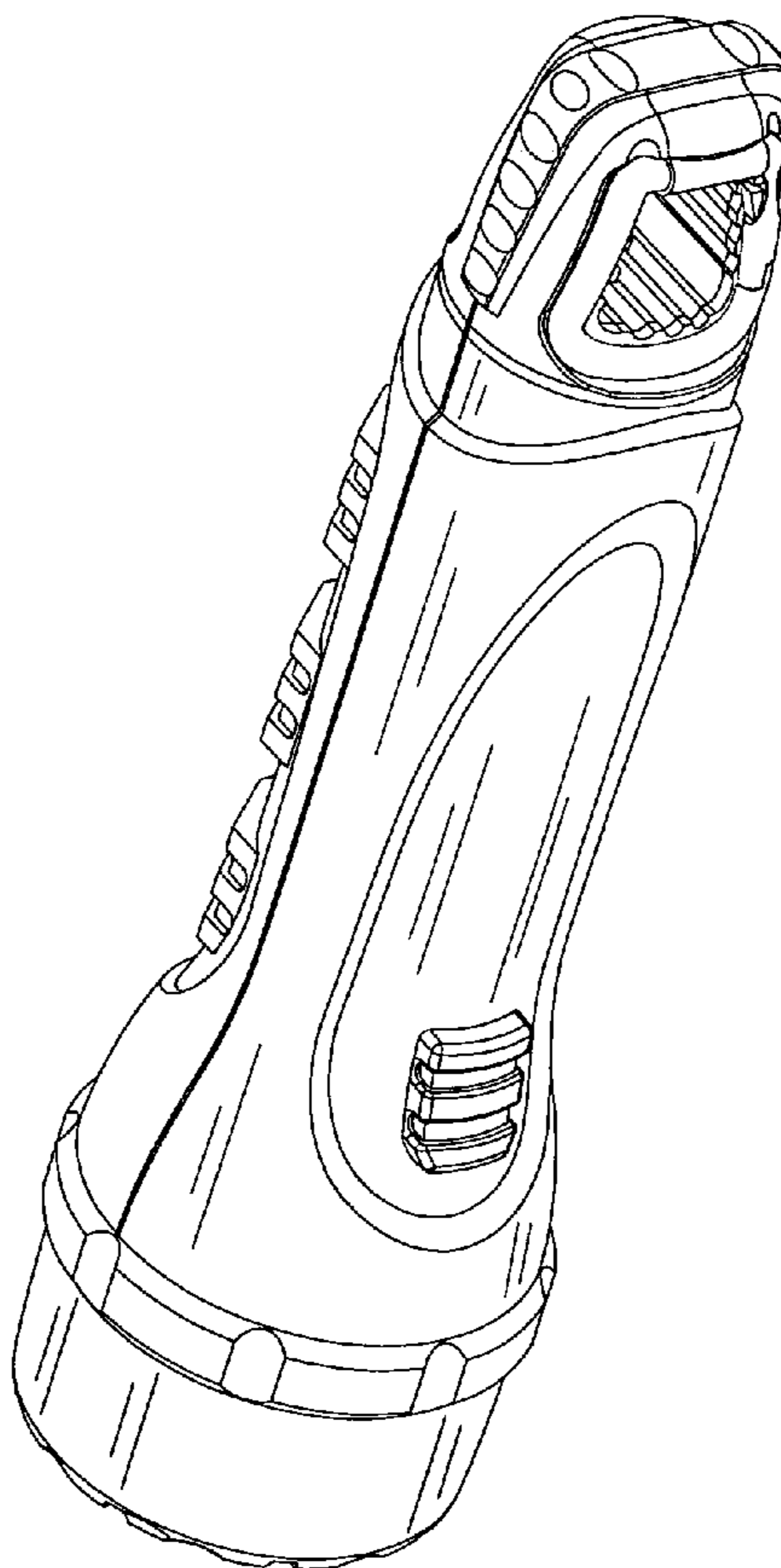

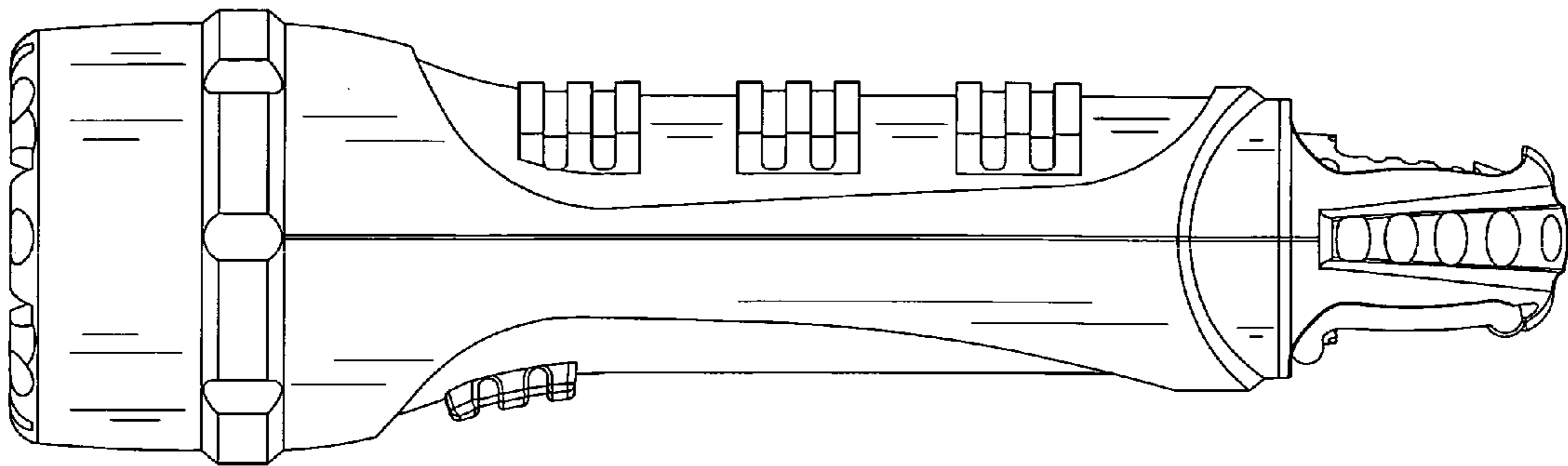

FIG. 1

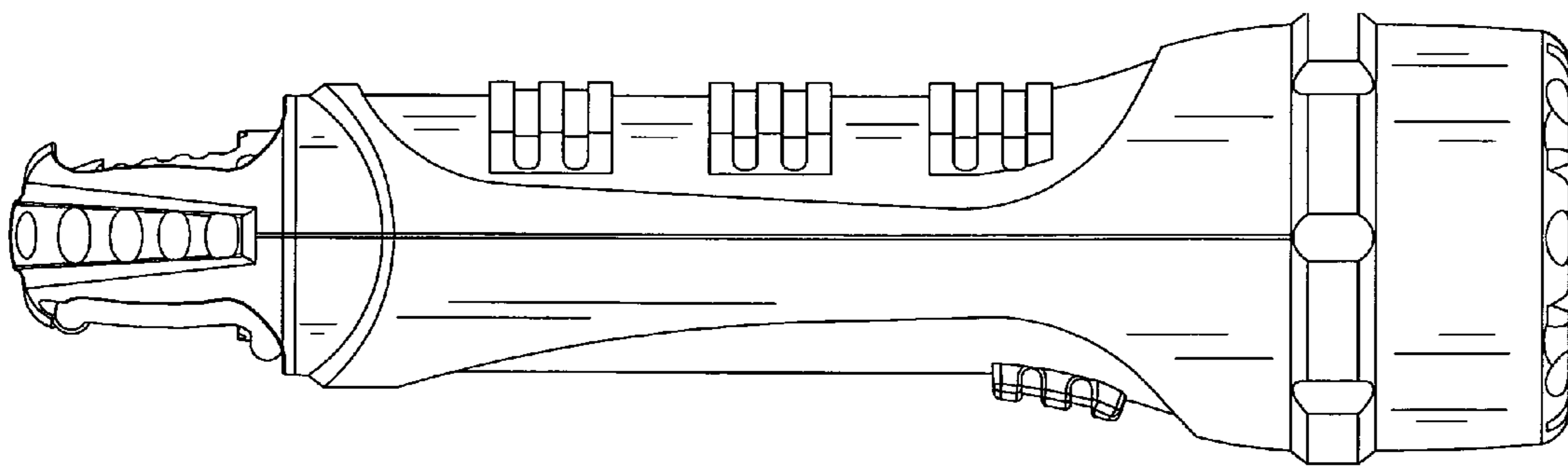

FIG. 2

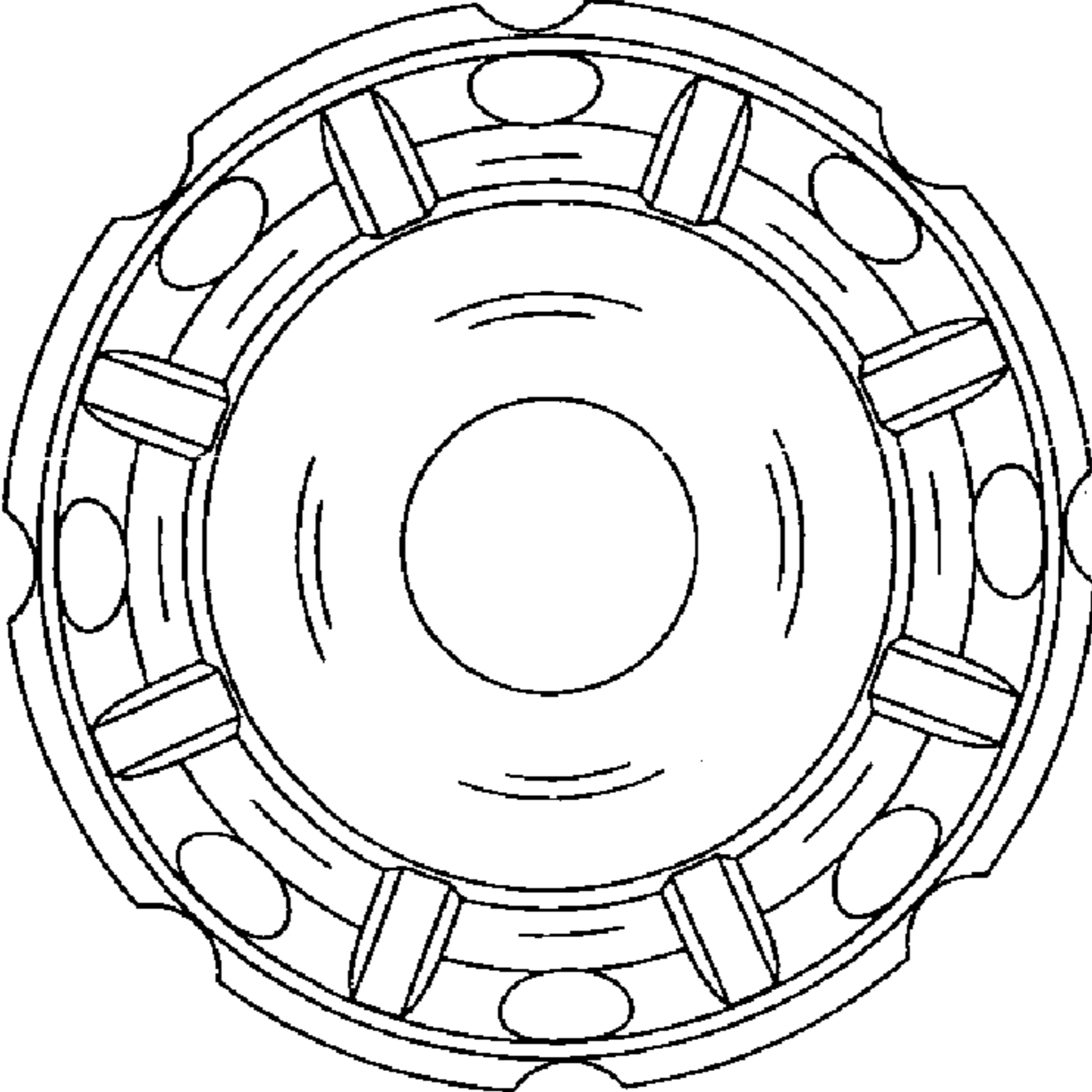

FIG. 3

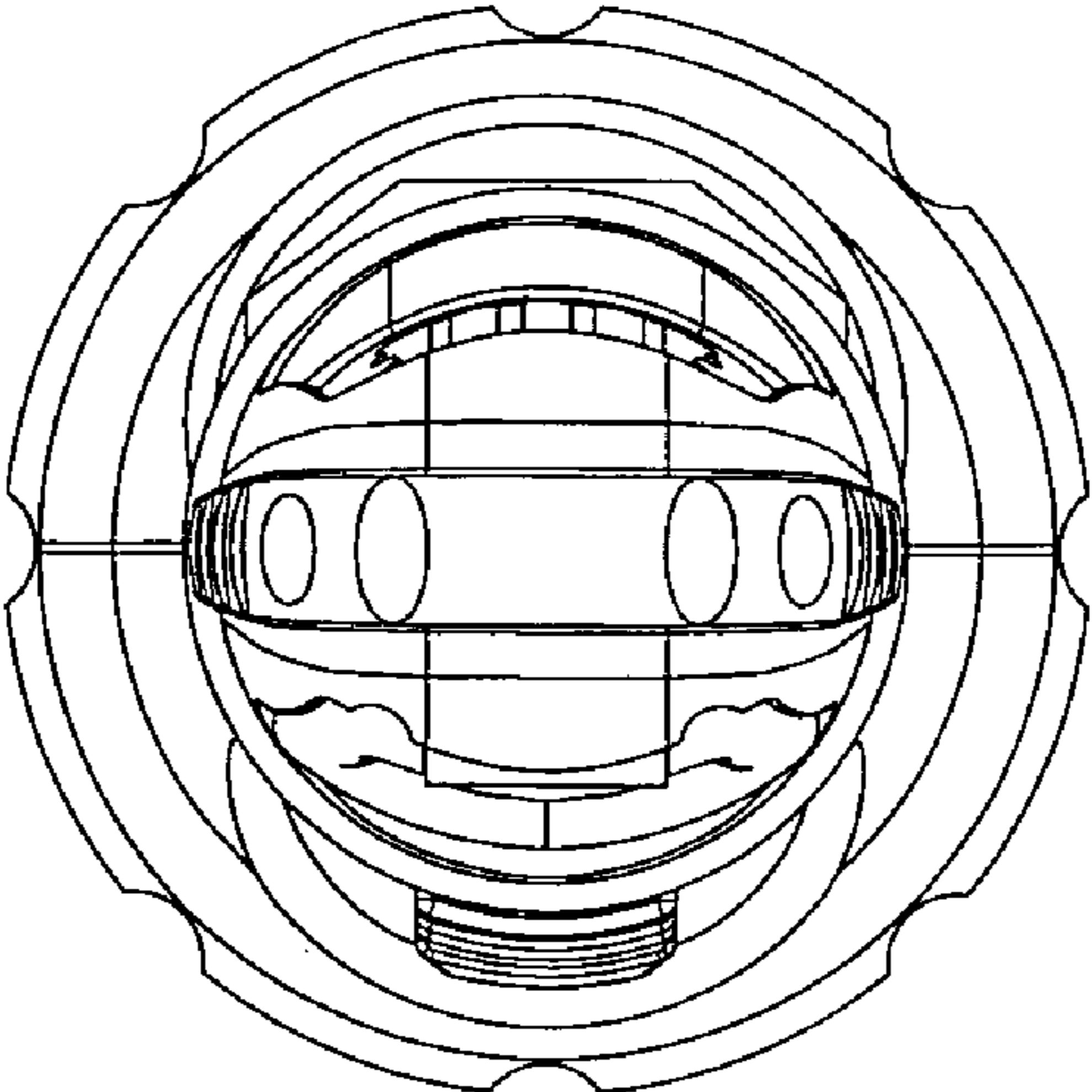

FIG. 4

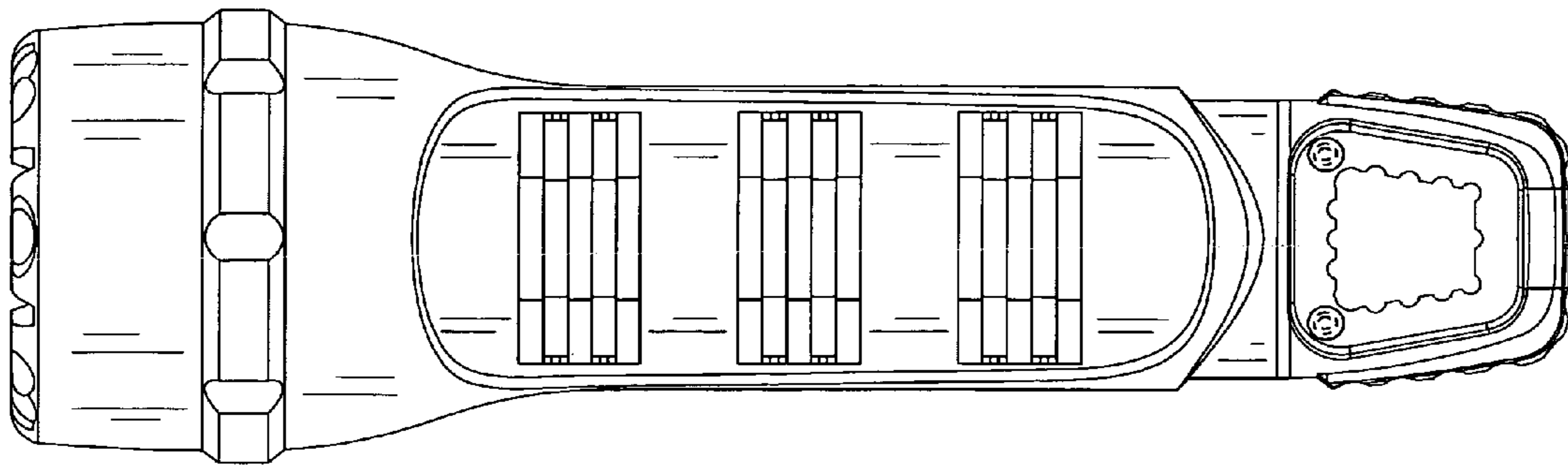

FIG. 5

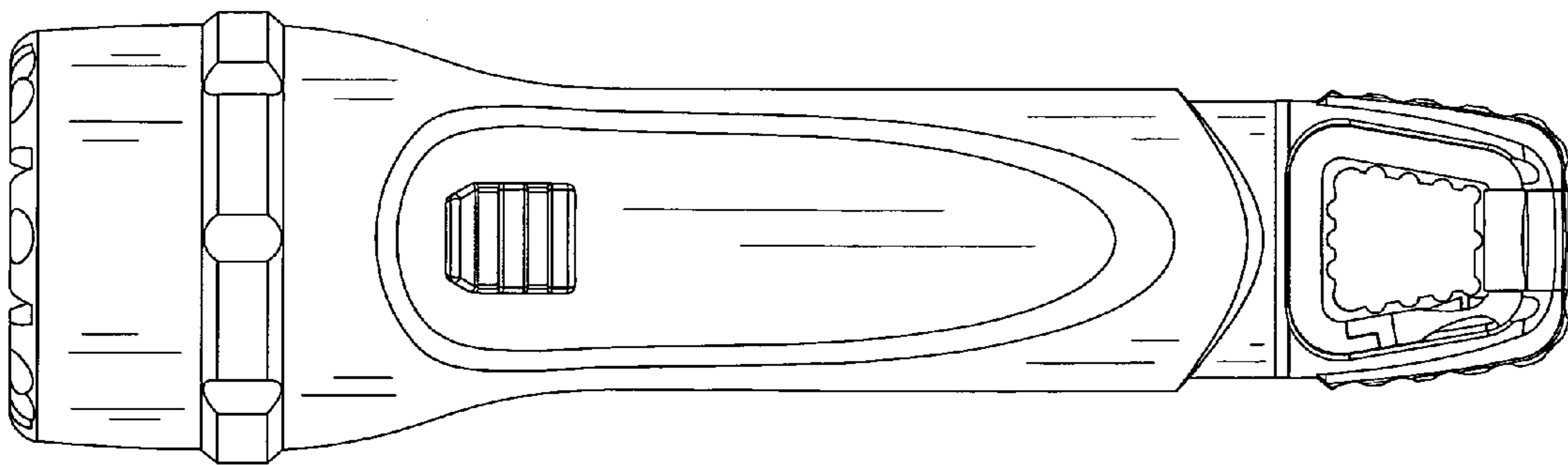

FIG. 6

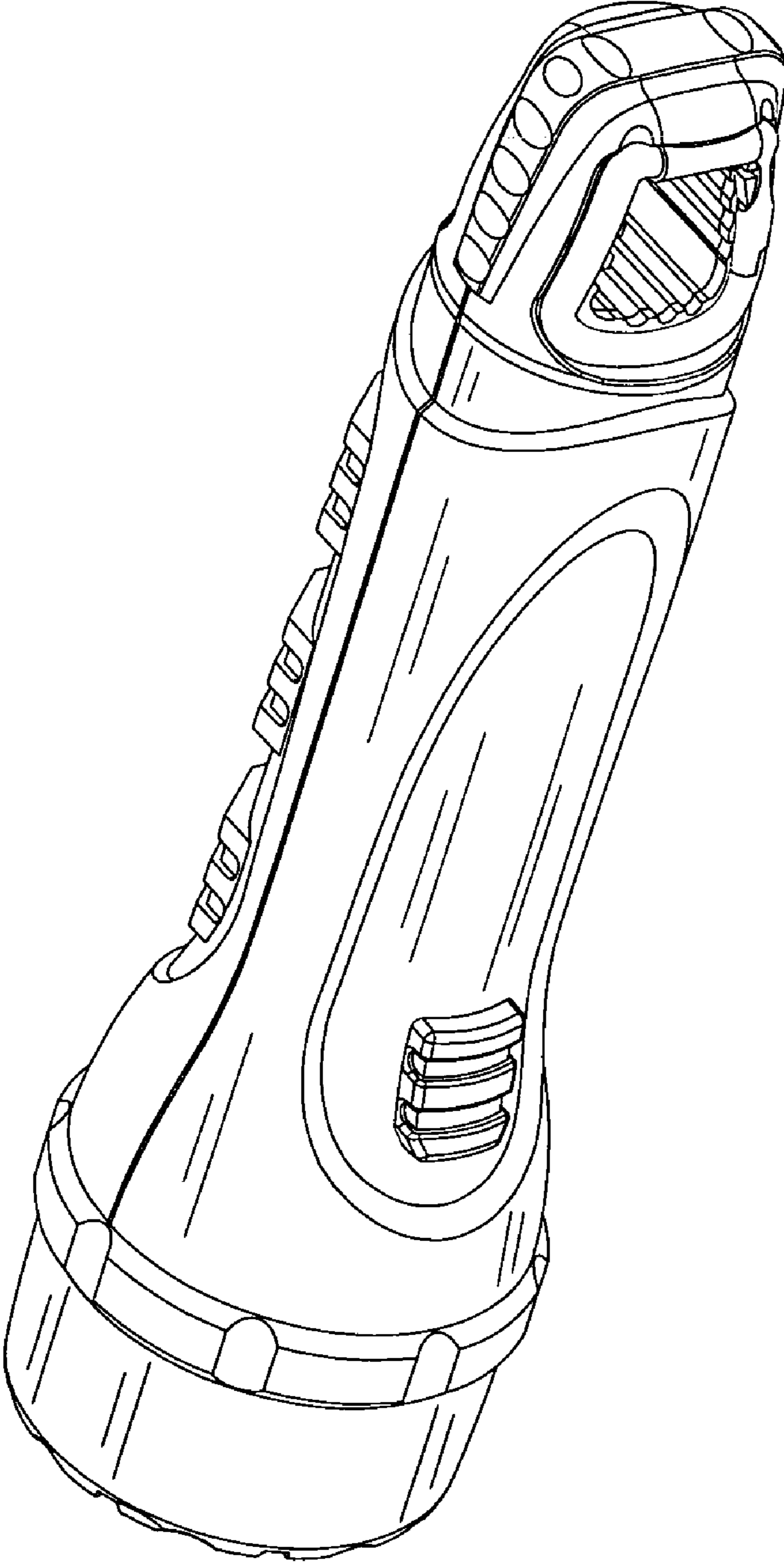

FIG. 7