

US00D606131S

(12) **United States Design Patent**  
**Ajitsu et al.**

(10) **Patent No.:** **US D606,131 S**

(45) **Date of Patent:** **\*\* Dec. 15, 2009**

(54) **TEDDY BEAR TOY**

(75) Inventors: **Miyako Ajitsu**, Tokyo (JP); **Fujio Nobata**, Tokyo (JP)

(73) Assignee: **Sega Toys Co., Ltd.**, Tokyo (JP)

(\*\*) Term: **14 Years**

(21) Appl. No.: **29/336,077**

(22) Filed: **Apr. 28, 2009**

(51) **LOC (9) Cl.** ..... **21-01**

(52) **U.S. Cl.** ..... **D21/585; D21/604; D21/578**

(58) **Field of Classification Search** ..... D21/576,  
D21/578, 584-585, 587-593, 595, 596, 604-605,  
D21/611-613, 655-656; D11/158; 446/72,  
446/97, 268-269, 279, 288, 369, 376  
See application file for complete search history.

(56) **References Cited**

**U.S. PATENT DOCUMENTS**

D415,540 S \* 10/1999 Sant ..... D21/605  
D472,283 S \* 3/2003 Akashi ..... D21/578

6,645,036 B1 \* 11/2003 Lund et al. .... 446/298  
D483,818 S \* 12/2003 Lewis et al. .... D21/605  
D525,365 S \* 7/2006 Mills ..... D21/604

\* cited by examiner

*Primary Examiner*—Sandra Morris

(74) *Attorney, Agent, or Firm*—The Marbury Law Group  
PLLC

(57) **CLAIM**

The ornamental design for a teddy bear toy, as shown and described.

**DESCRIPTION**

FIG. 1 is a front view of a teddy bear toy showing our new design.

FIG. 2 is a rear view thereof.

FIG. 3 is a top plan view thereof.

FIG. 4 is a bottom plan view thereof.

FIG. 5 is a left side view thereof; and,

FIG. 6 is a right side view thereof.

**1 Claim, 5 Drawing Sheets**

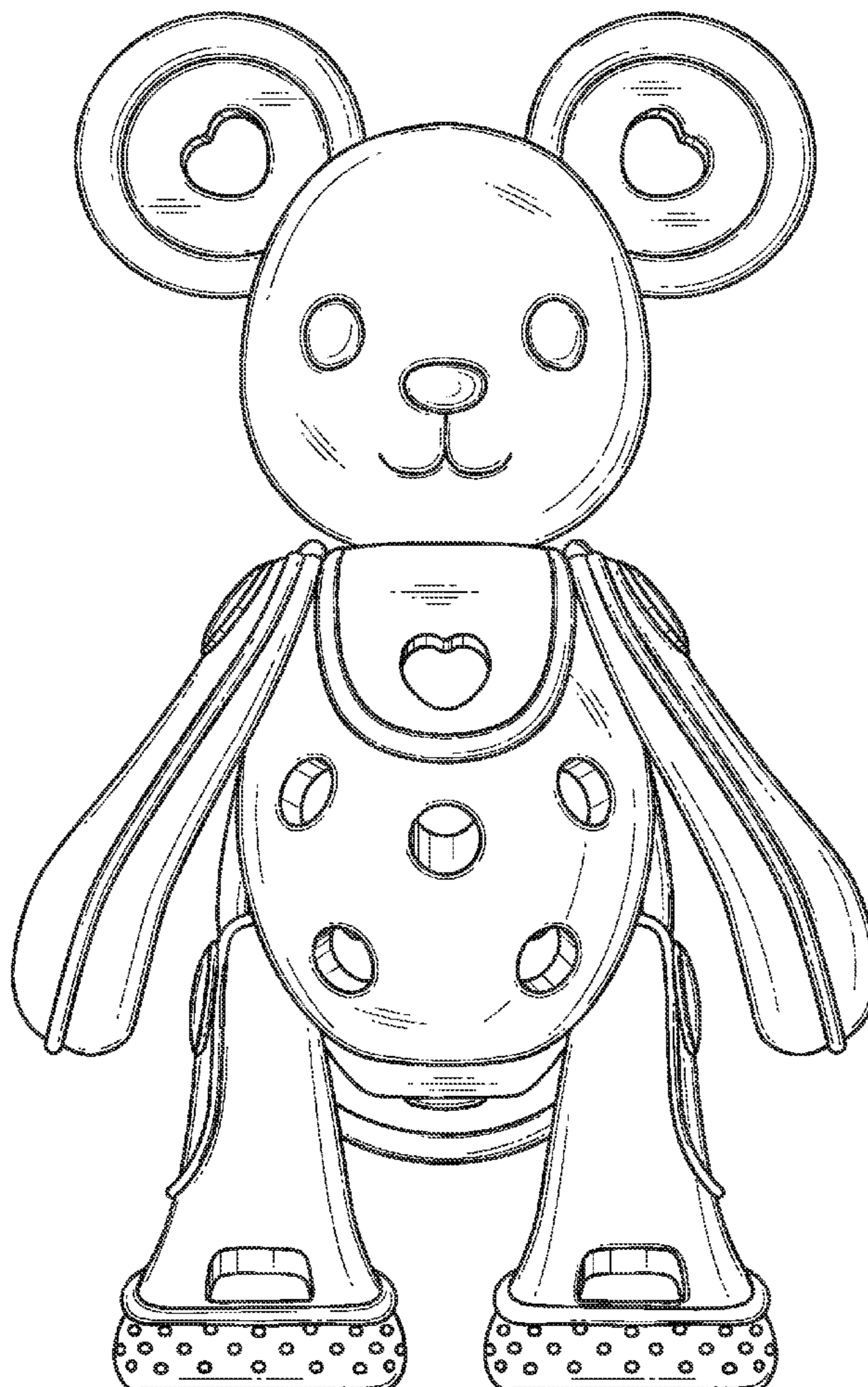

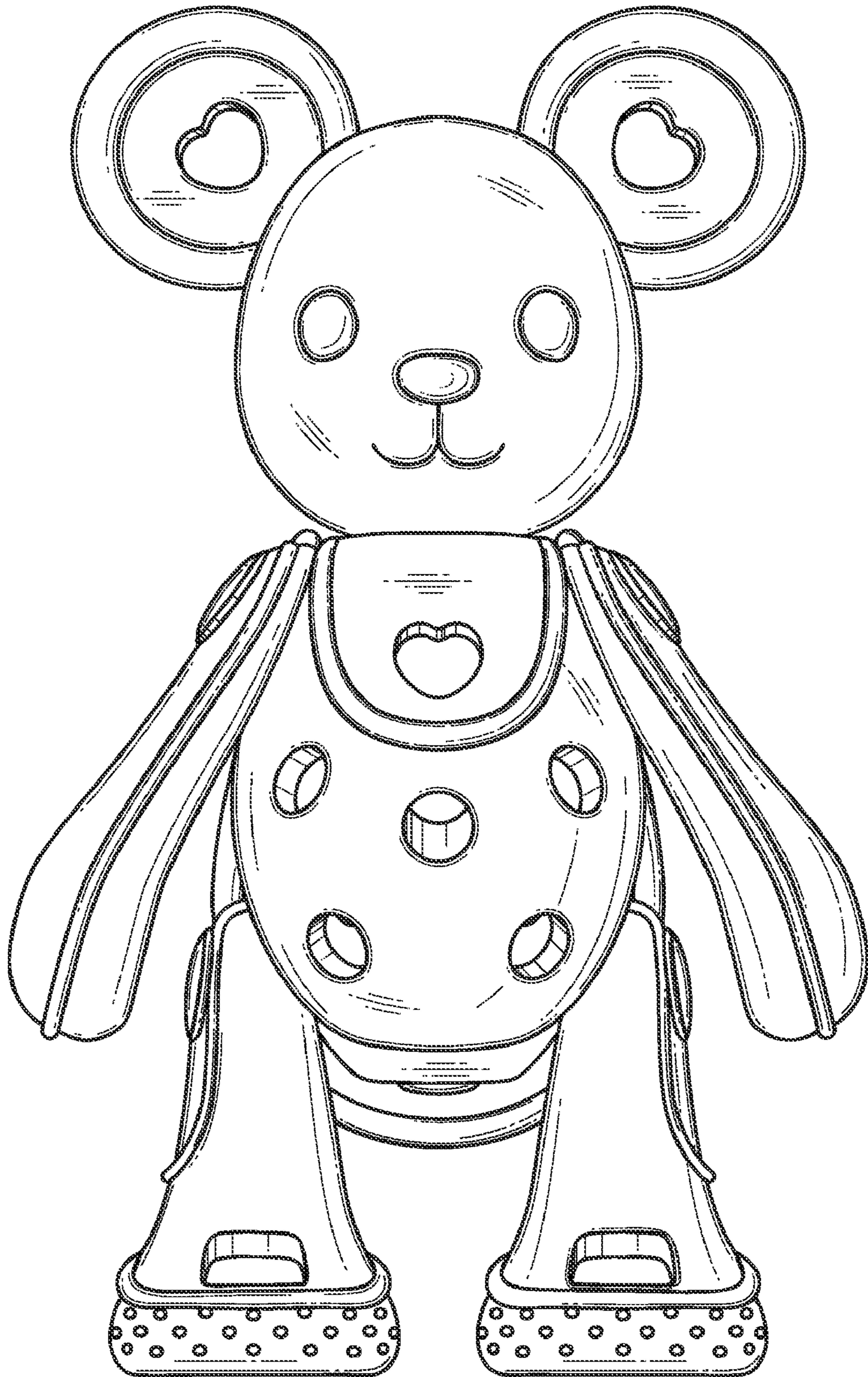

FIG. 1

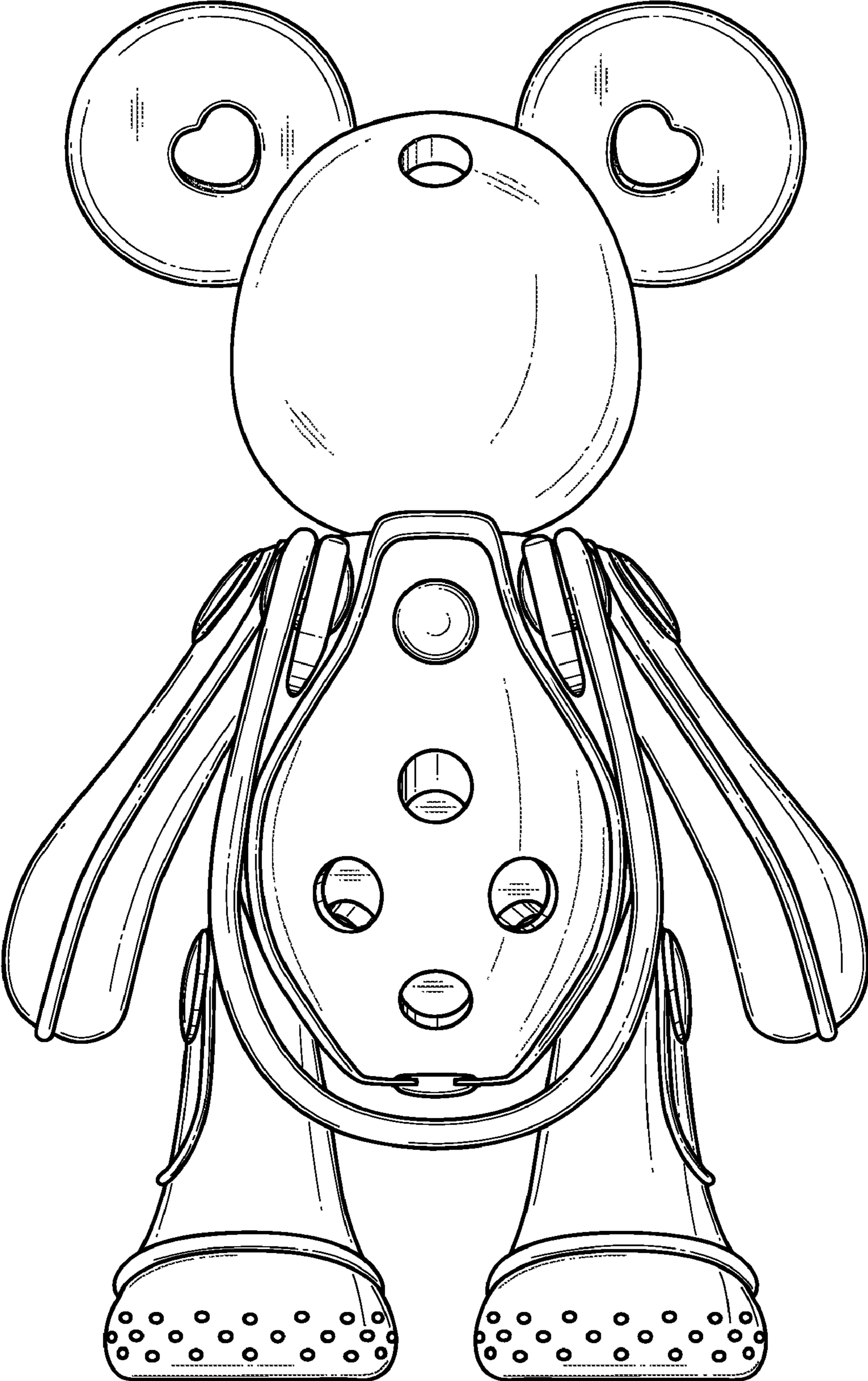

FIG. 2

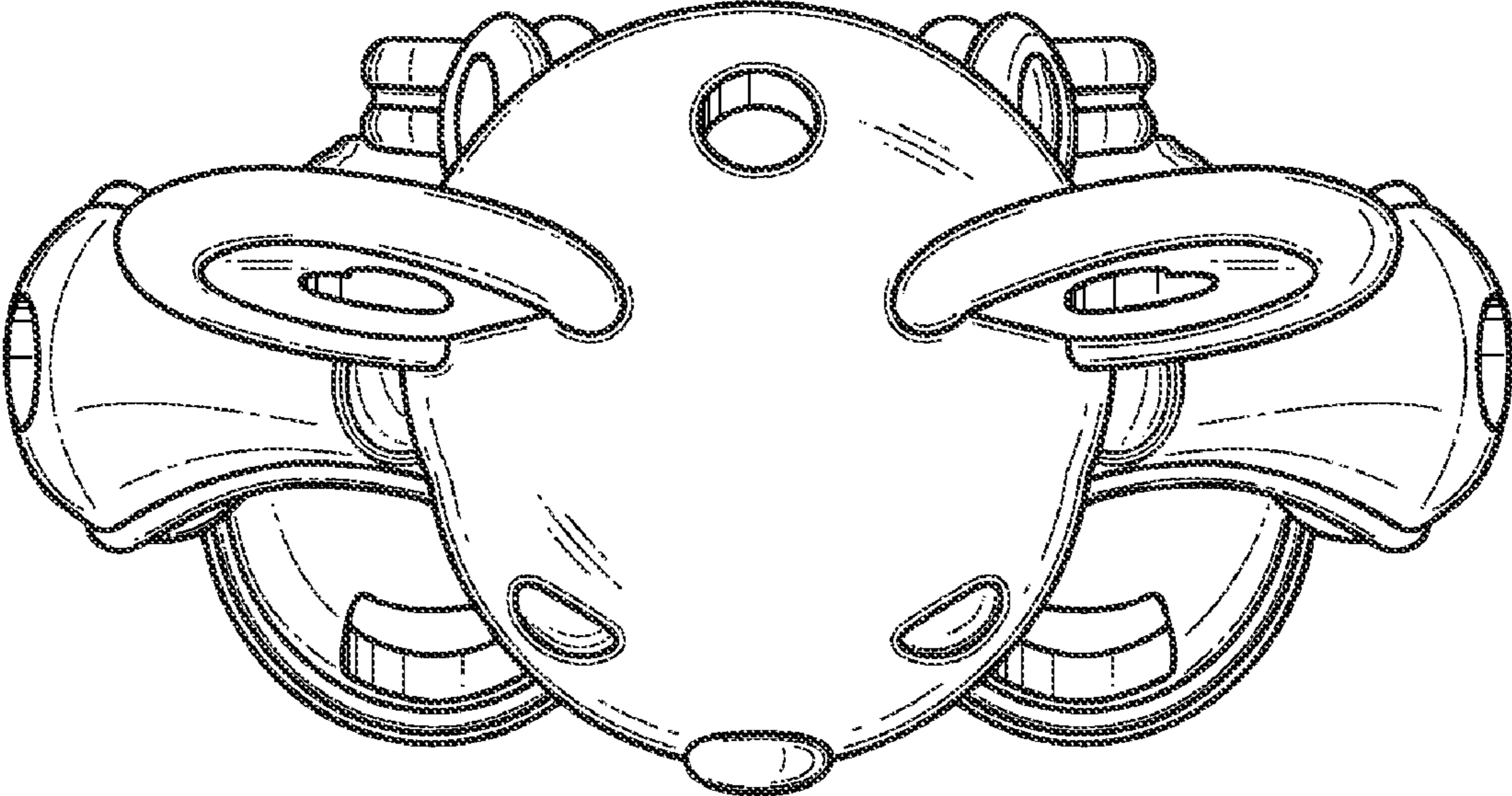

FIG. 3

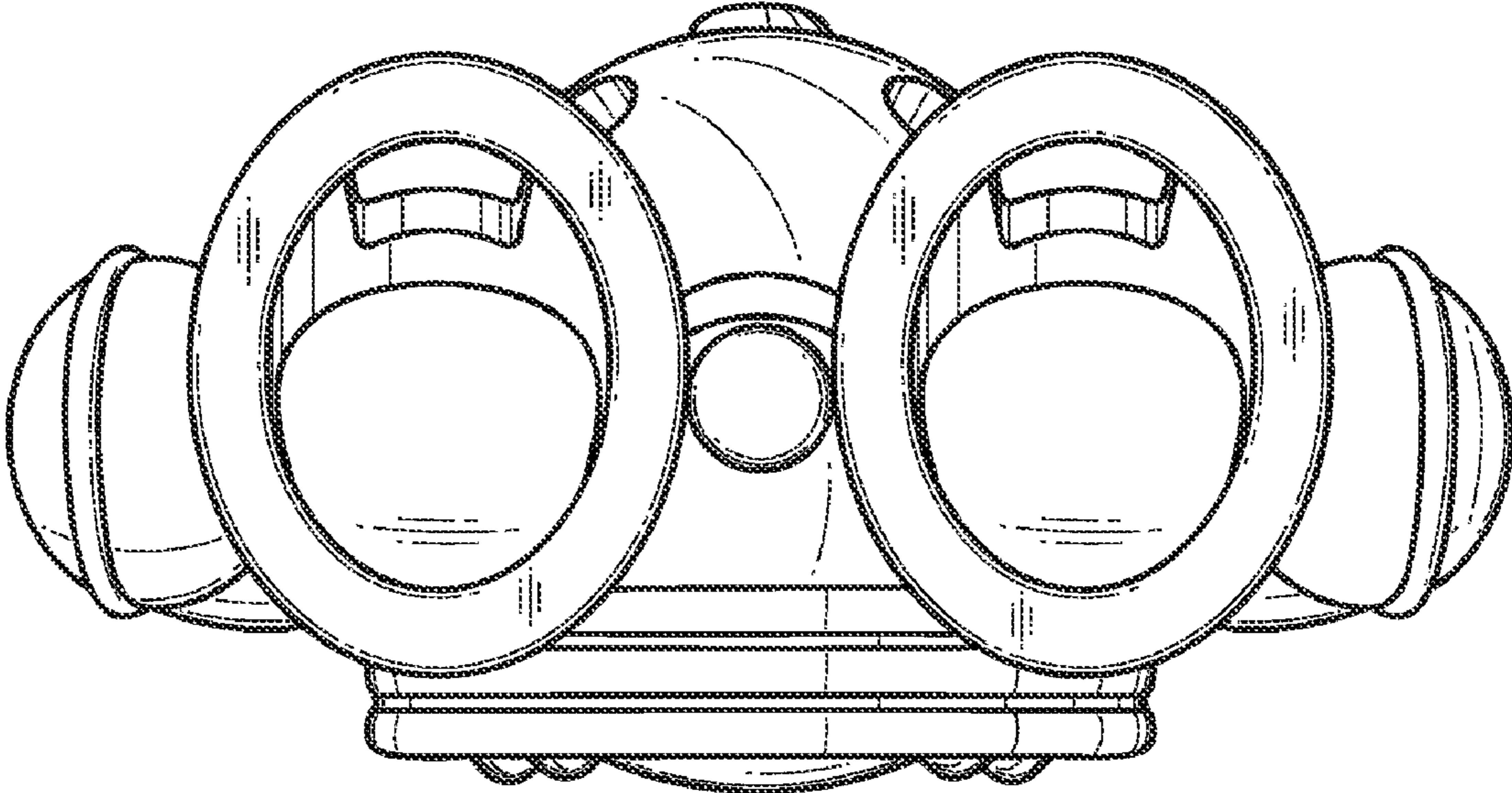

FIG. 4

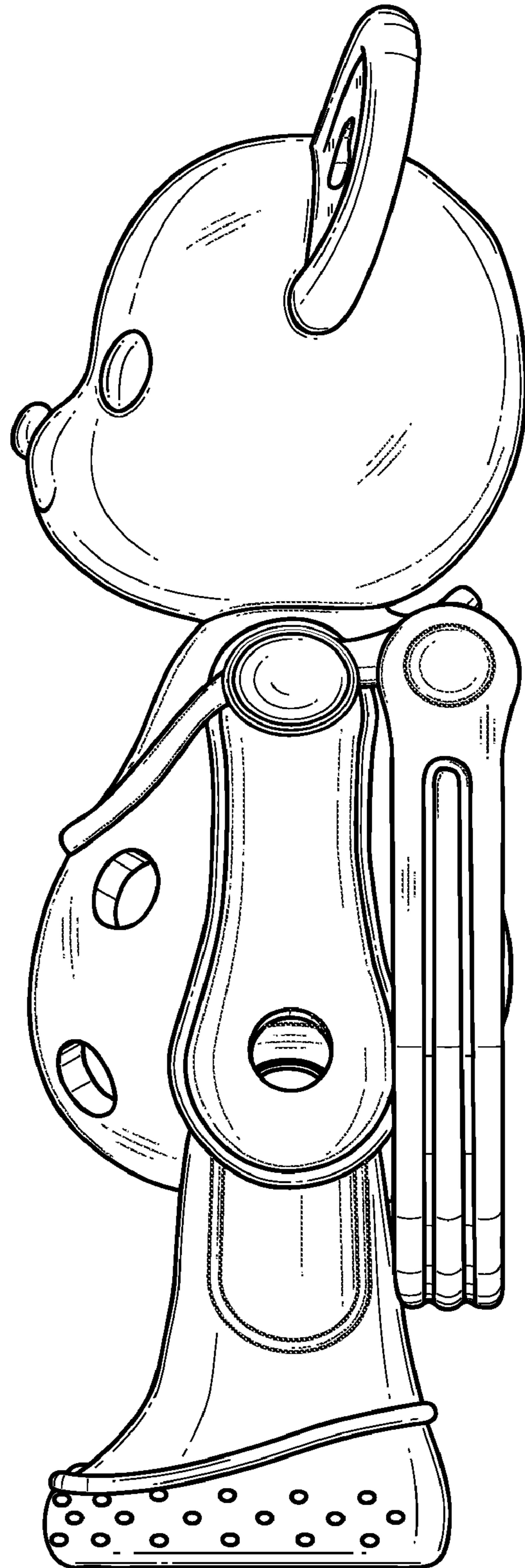

FIG. 5

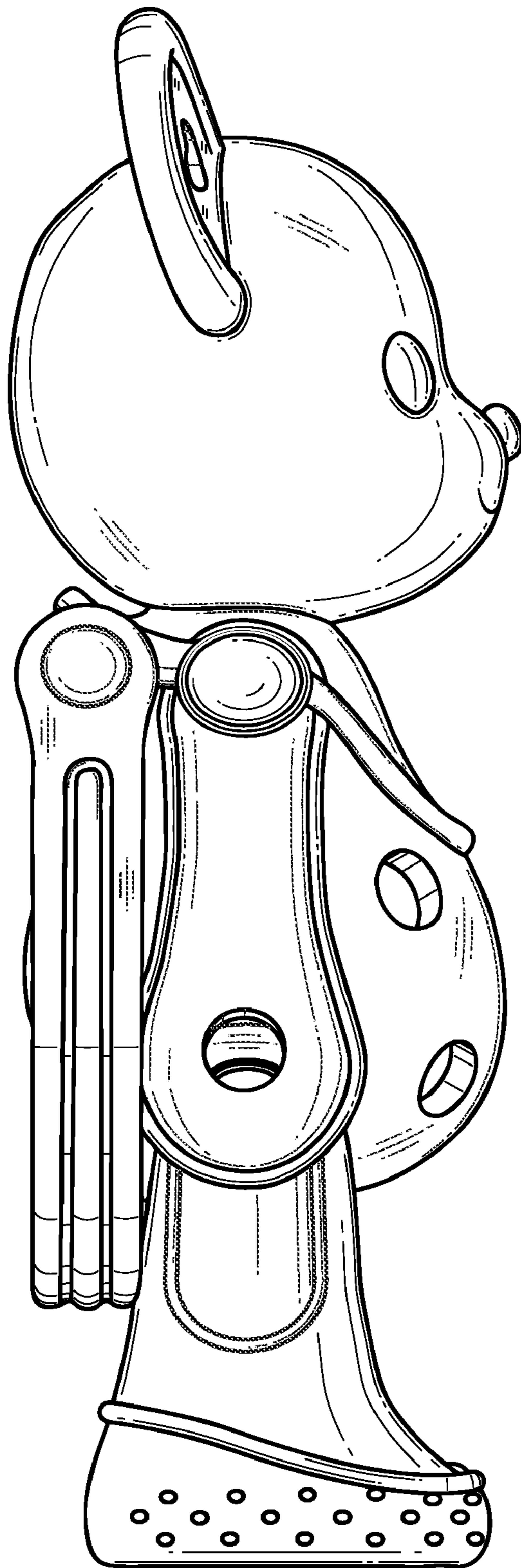

FIG. 6