



US00D606105S

(12) **United States Design Patent**
Hinkel

(10) **Patent No.:** **US D606,105 S**

(45) **Date of Patent:** **** Dec. 15, 2009**

(54) **SURVEILLANCE CAMERA**

(75) Inventor: **Ralf Hinkel**, Horingen (DE)

(73) Assignee: **Mobotix AG**, Kaiserslautern (DE)

(**) Term: **14 Years**

(21) Appl. No.: **29/304,360**

(22) Filed: **Feb. 29, 2008**

Related U.S. Application Data

(63) Continuation of application No. 29/261,191, filed on Jun. 9, 2006, now abandoned.

(30) **Foreign Application Priority Data**

Dec. 10, 2005 (DE) 405 06 342

(51) **LOC (9) Cl.** **16-02**

(52) **U.S. Cl.** **D16/203**

(58) **Field of Classification Search** D16/200–208,
D16/210, 211, 217–218; 348/143, 151, 373–376;
396/427, 535–541

See application file for complete search history.

(56) **References Cited**

U.S. PATENT DOCUMENTS

3,732,368	A	5/1973	Mahlab	
4,080,629	A	3/1978	Hammond et al.	
4,320,949	A *	3/1982	Pagano	396/427
4,510,526	A	4/1985	Coutta et al.	
4,833,534	A *	5/1989	Paff et al.	348/151
4,984,089	A	1/1991	Stiepel et al.	
5,028,997	A	7/1991	Elberbaum	
5,121,215	A	6/1992	Boers et al.	
D340,940	S	11/1993	Ellenberger et al.	
D349,714	S	8/1994	Hasegawa	
7,281,867	B2 *	10/2007	Takahashi	396/427
7,324,154	B2 *	1/2008	Cheng	348/373
D576,193	S *	9/2008	Su et al.	D16/203
7,425,101	B2 *	9/2008	Cheng	396/427
2005/0206779	A1	9/2005	Aoki et al.	
2006/0109374	A1	5/2006	Cheng	

* cited by examiner

Primary Examiner—Ian Simmons

Assistant Examiner—Wan Laymon

(74) *Attorney, Agent, or Firm*—Baker & Daniels LLP

(57) **CLAIM**

The ornamental design for a surveillance camera, as shown and described.

DESCRIPTION

FIG. 1 is a bottom perspective view of a surveillance camera showing my new design, with the wall details shown in broken lines;

FIG. 2 is a left side view thereof;

FIG. 3 is a right side view thereof;

FIG. 4 is a front view thereof;

FIG. 5 is a top view thereof;

FIG. 6 is a bottom view thereof;

FIG. 7 is a rear and top perspective view thereof;

FIG. 8 is a front and bottom perspective view of a surveillance camera with the mount bracket shown removed for ease of illustration thereof;

FIG. 9 is a rear view thereof;

FIG. 10 is a bottom view thereof;

FIG. 11 is a right side view thereof;

FIG. 12 is a left side view thereof;

FIG. 13 is a bottom view of a surveillance camera with the housing, mount bracket and protective cover shown removed for ease of illustration thereof;

FIG. 14 is a right perspective view thereof;

FIG. 15 is a left perspective view thereof;

FIG. 16 is a front view thereof;

FIG. 17 is a rear view thereof;

FIG. 18 is a left side view thereof;

FIG. 19 is a right side view thereof;

FIG. 20 is a bottom view of a surveillance camera with the housing, mount bracket and protective cover shown removed for ease of illustration thereof;

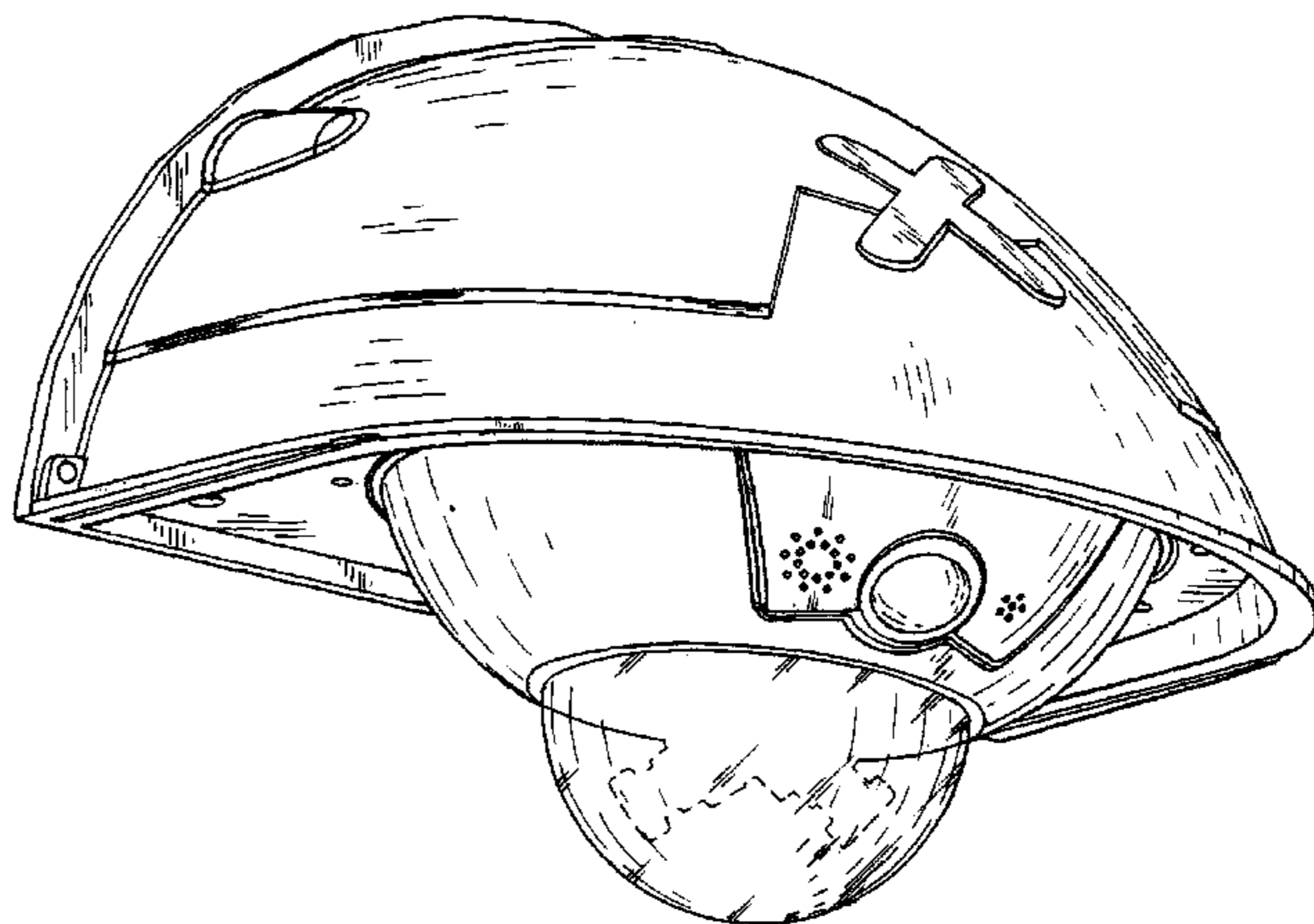
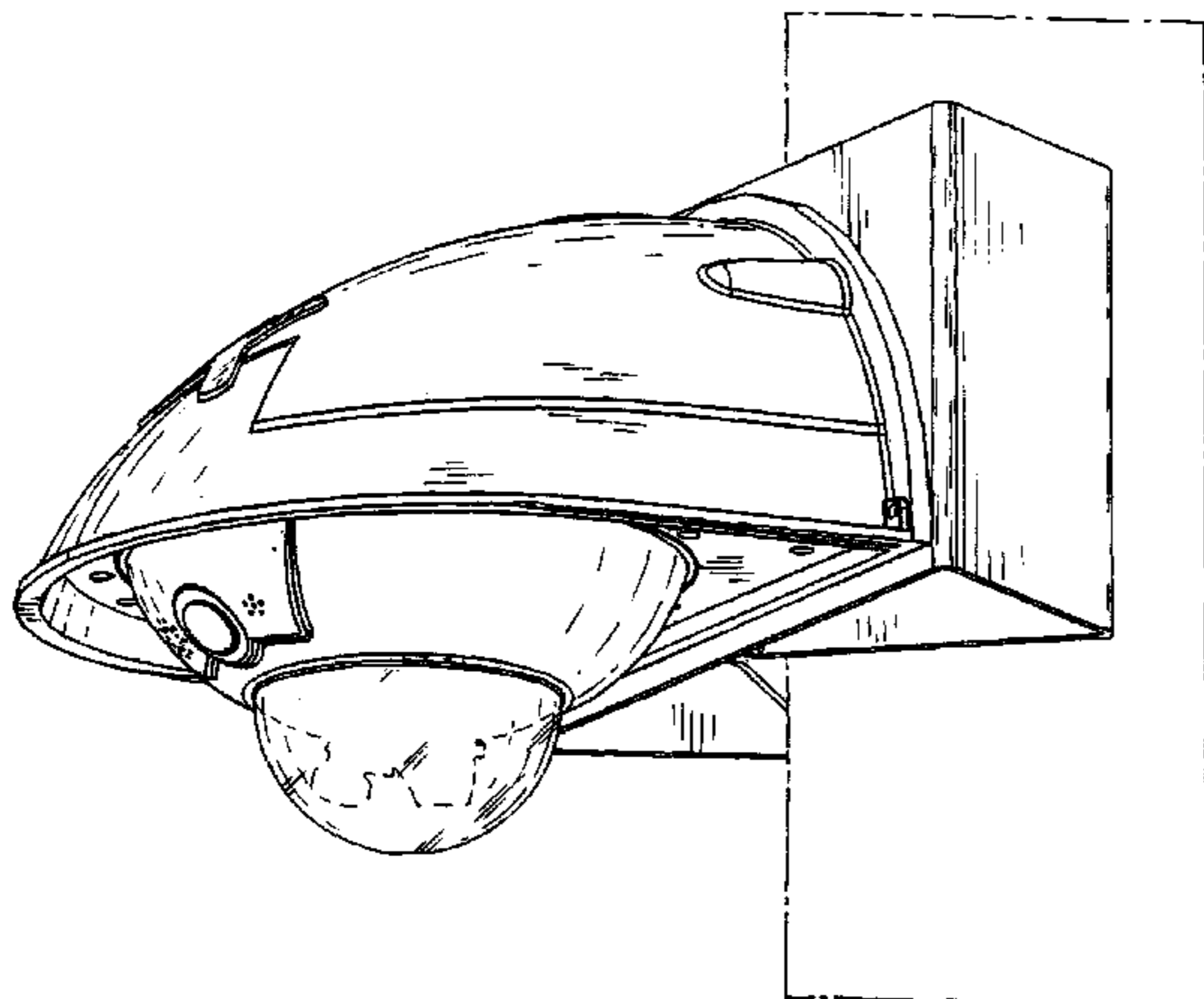

FIG. **21** is a right side view thereof;

FIG. **22** is a rear view thereof;

FIG. **23** is a left side view thereof;

FIG. **24** is a front side view thereof;

FIG. **25** is a side view of a surveillance camera with the camera, housing and mount bracket shown removed for ease of illustration thereof;

FIG. **26** is a rear view thereof;

FIG. **27** is a front perspective view thereof;

FIG. **28** is a top view thereof;

FIG. **29** is a bottom view thereof;

FIG. **30** is a front elevation view of the mount bracket;

FIG. **31** is a side view thereof;

FIG. **32** is a rear view thereof; and,

FIG. **33** is a top view thereof.

The broken line showing portions of a surveillance camera is included for the purpose of illustrating environmental structure and forms no part of the claimed design.

1 Claim, 33 Drawing Sheets

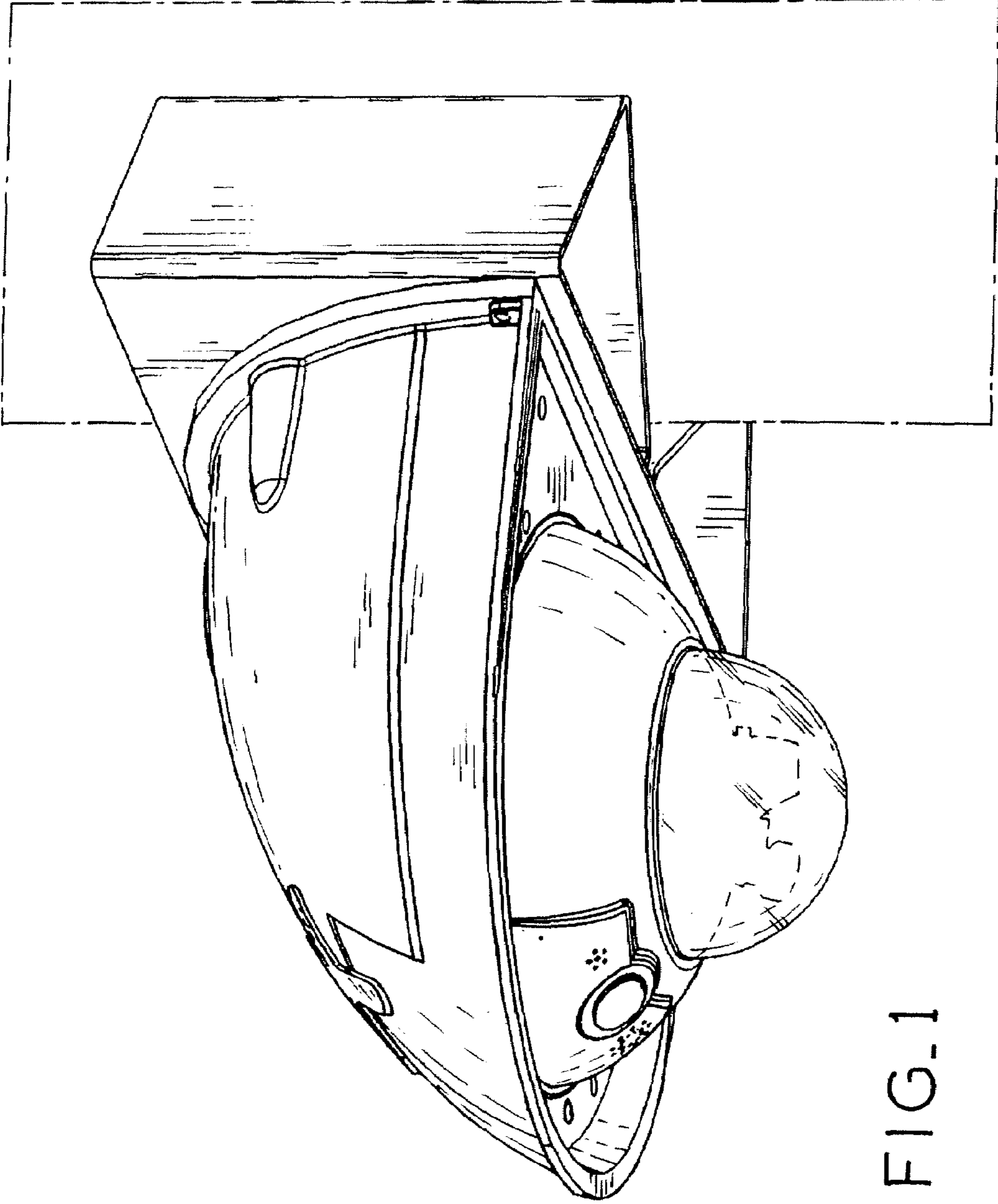

FIG. 1

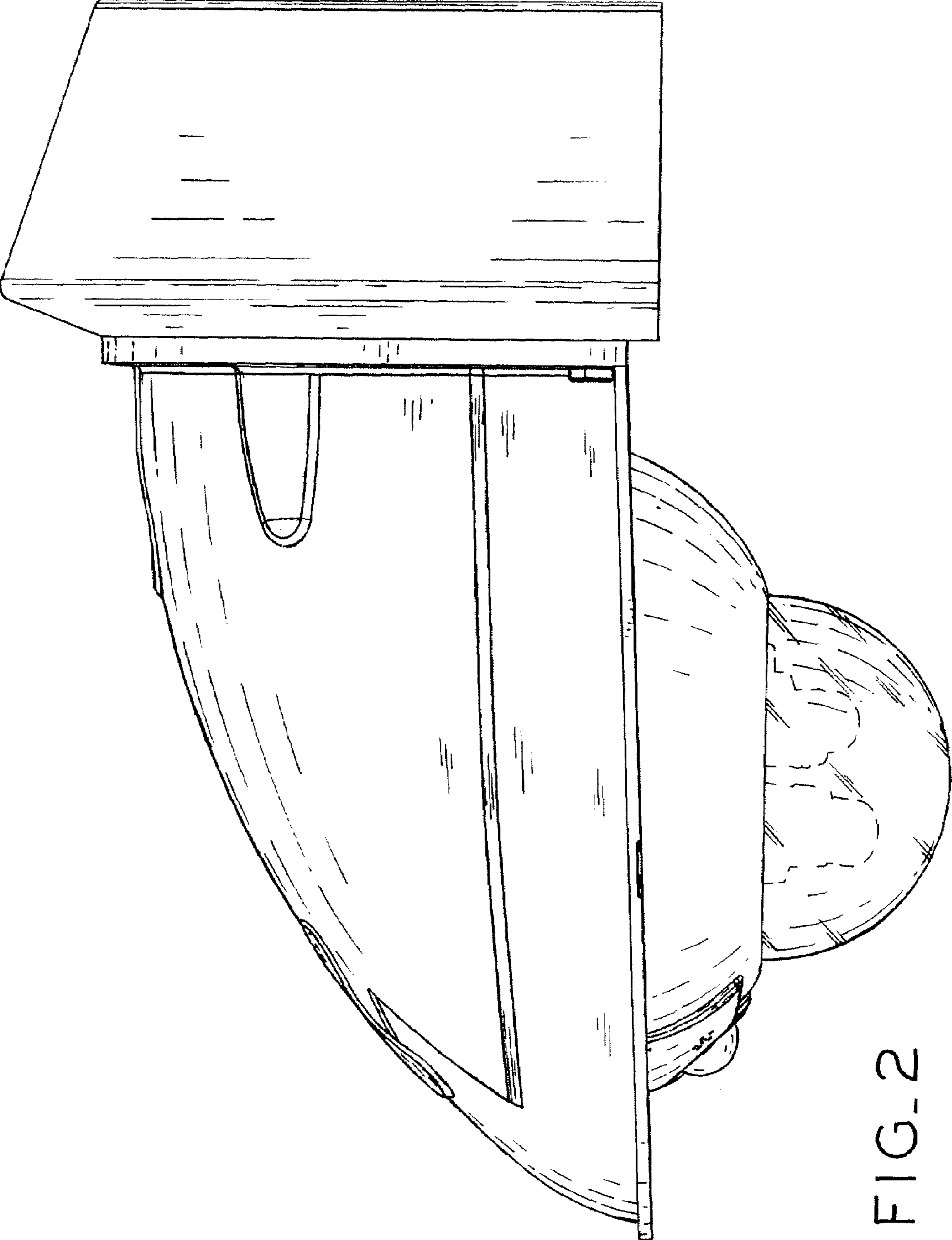

FIG. 2

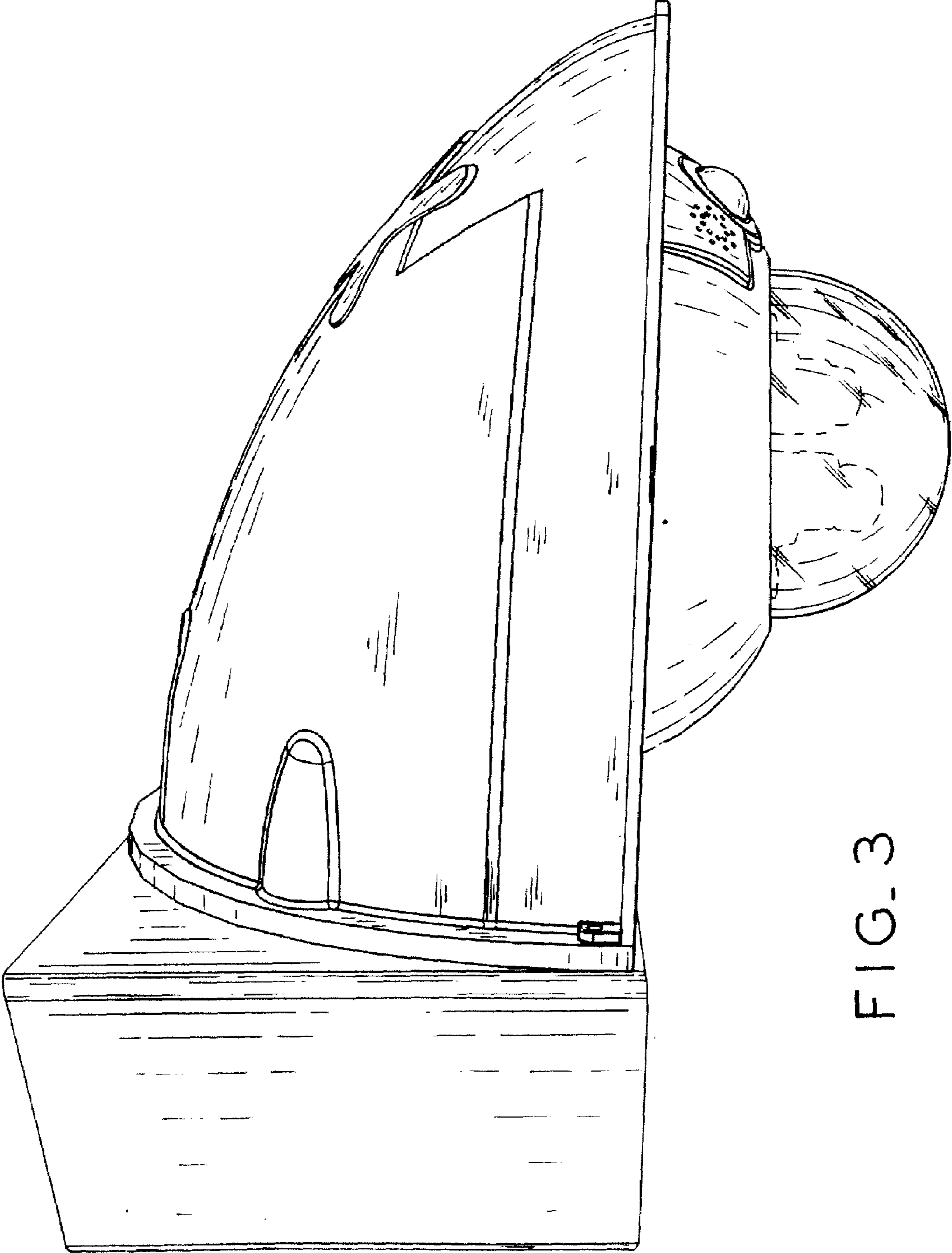

FIG. 3

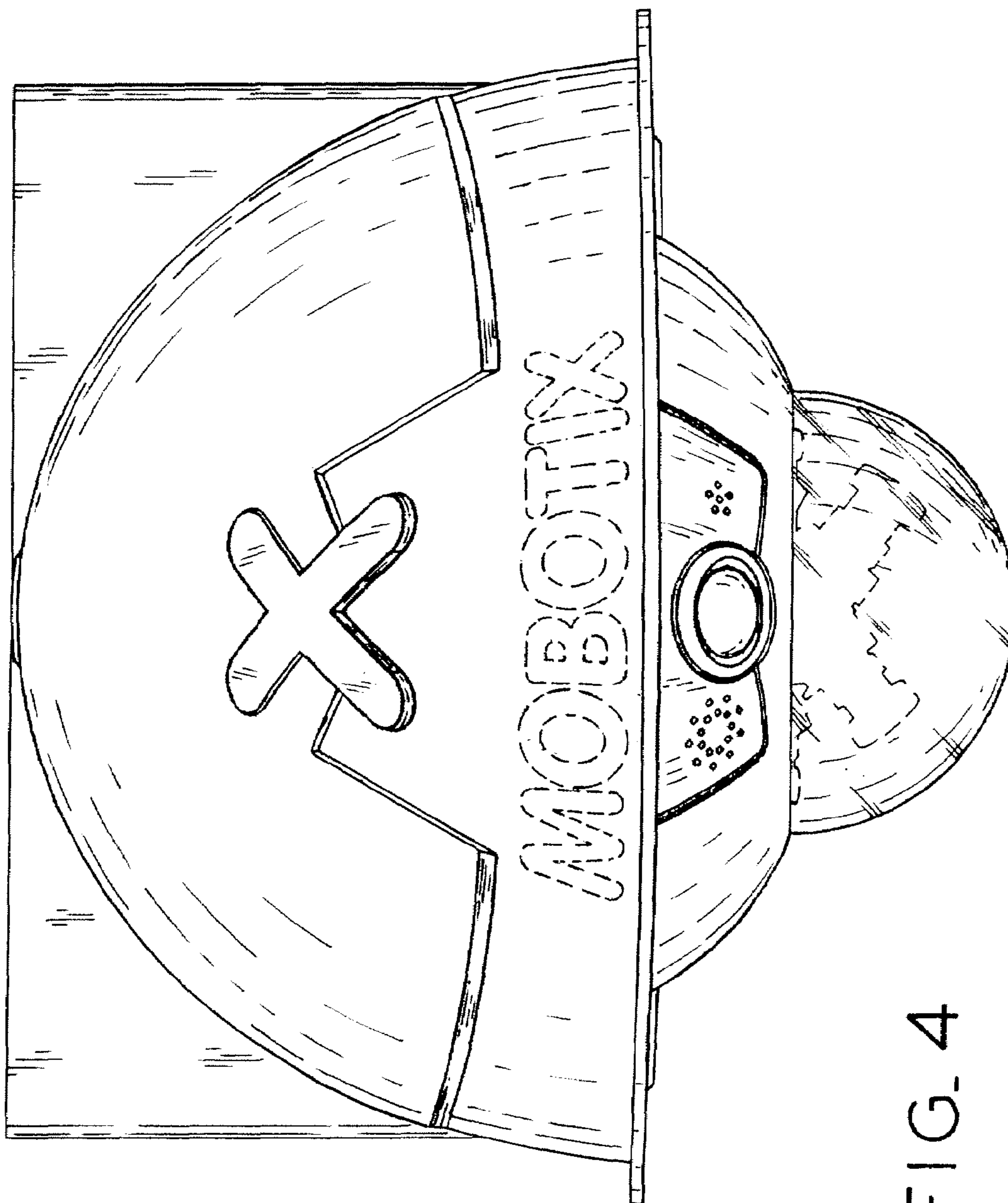

FIG. 4

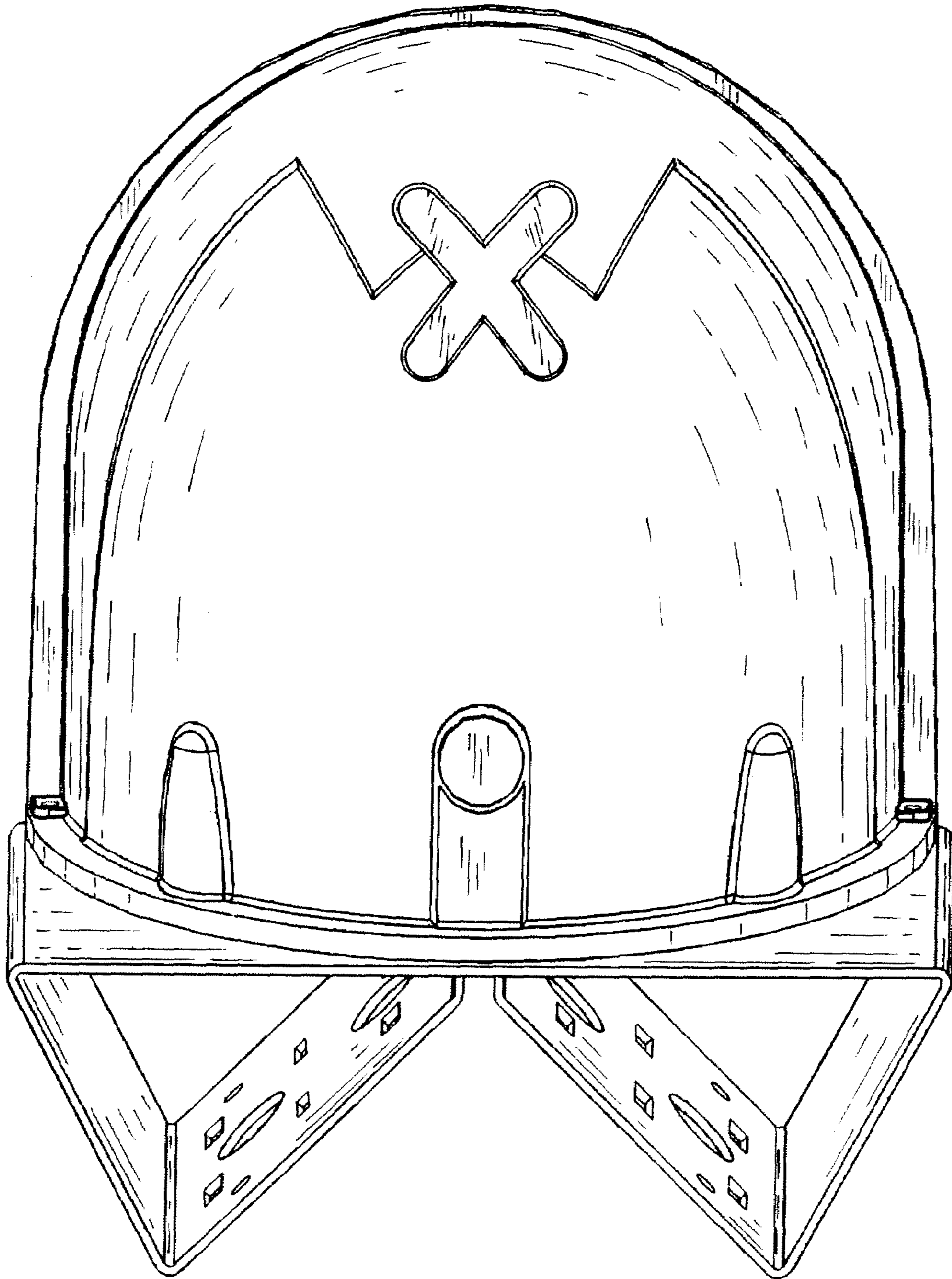

FIG. 5

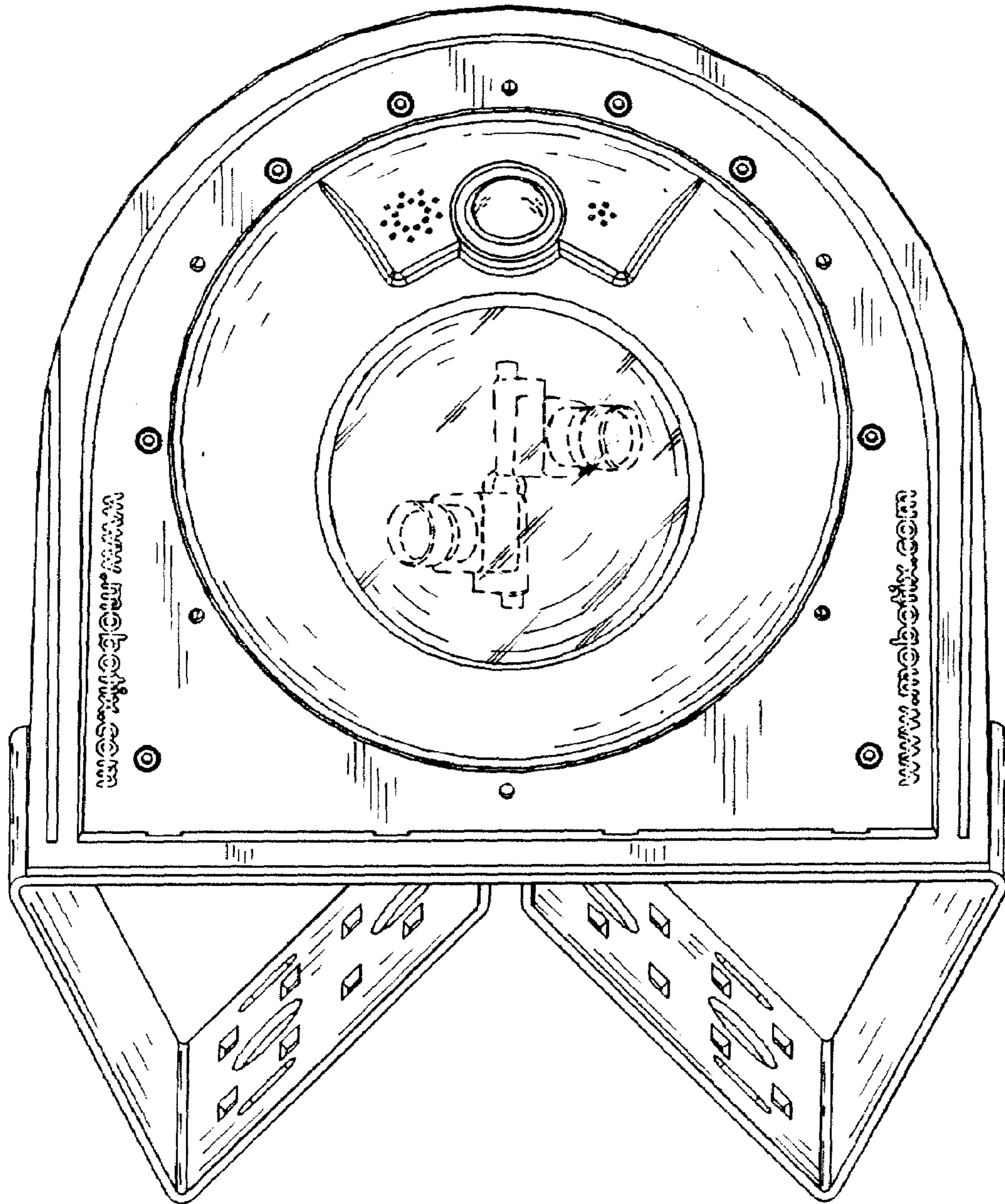

FIG. 6

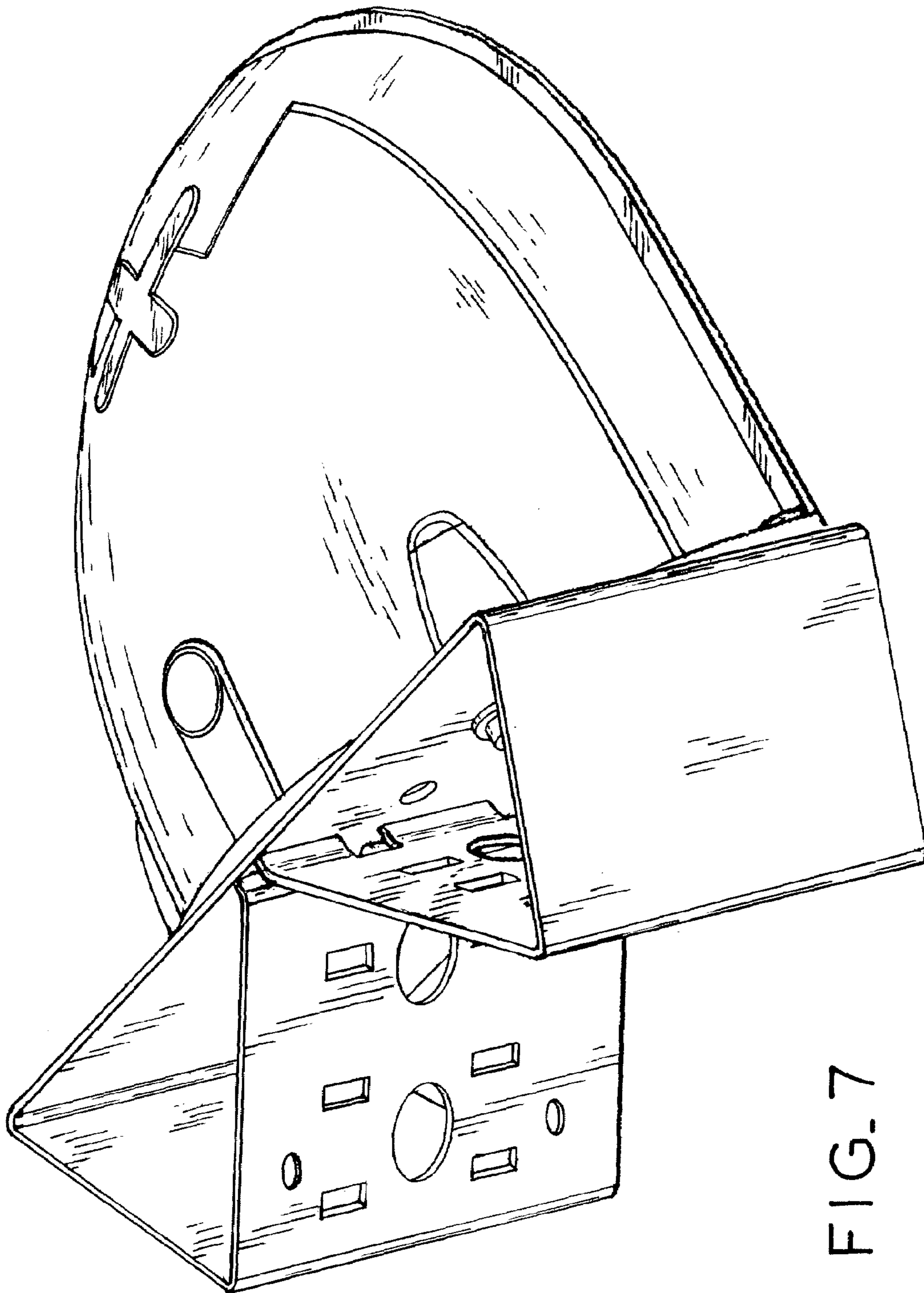

FIG. 7

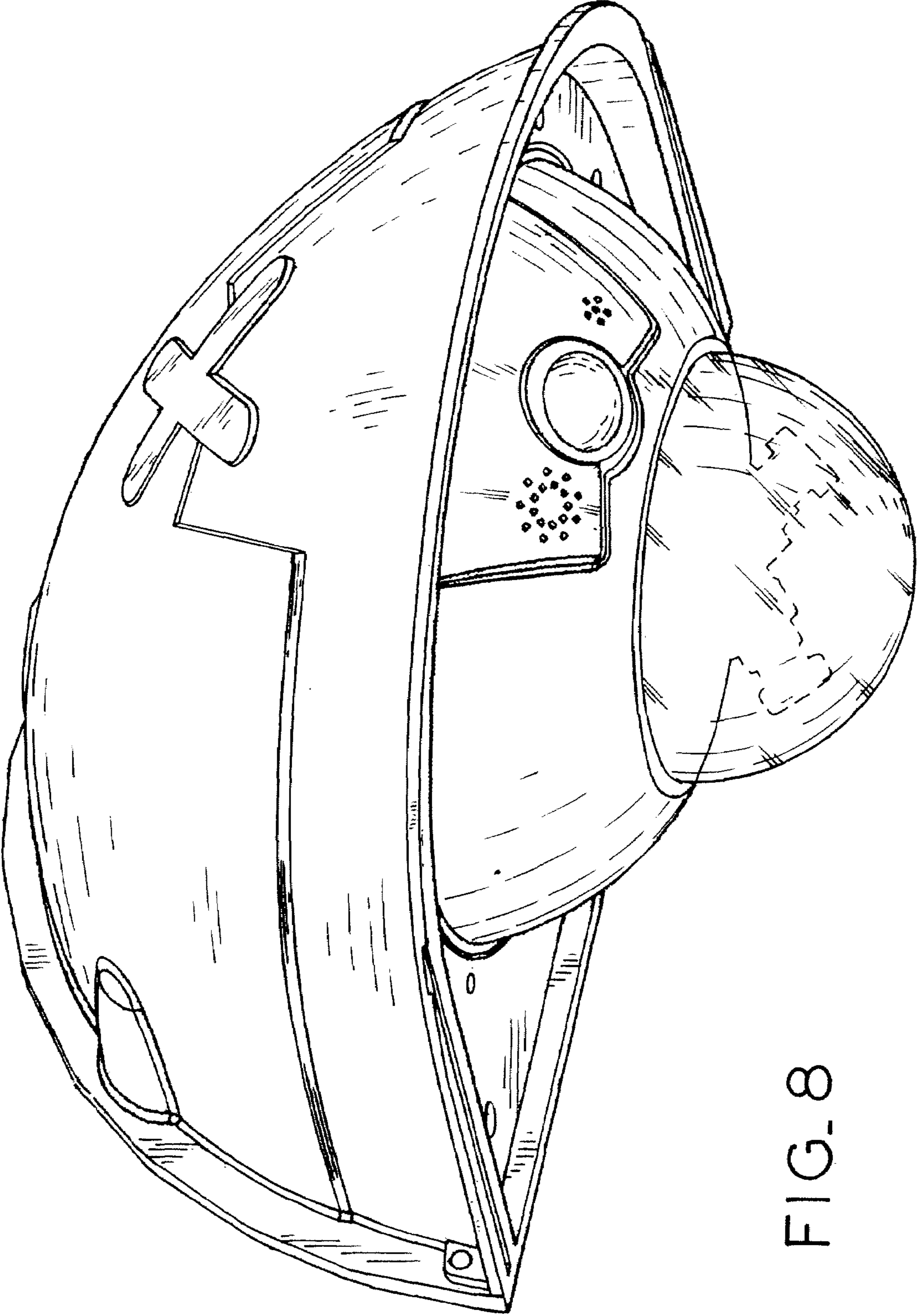

FIG. 8

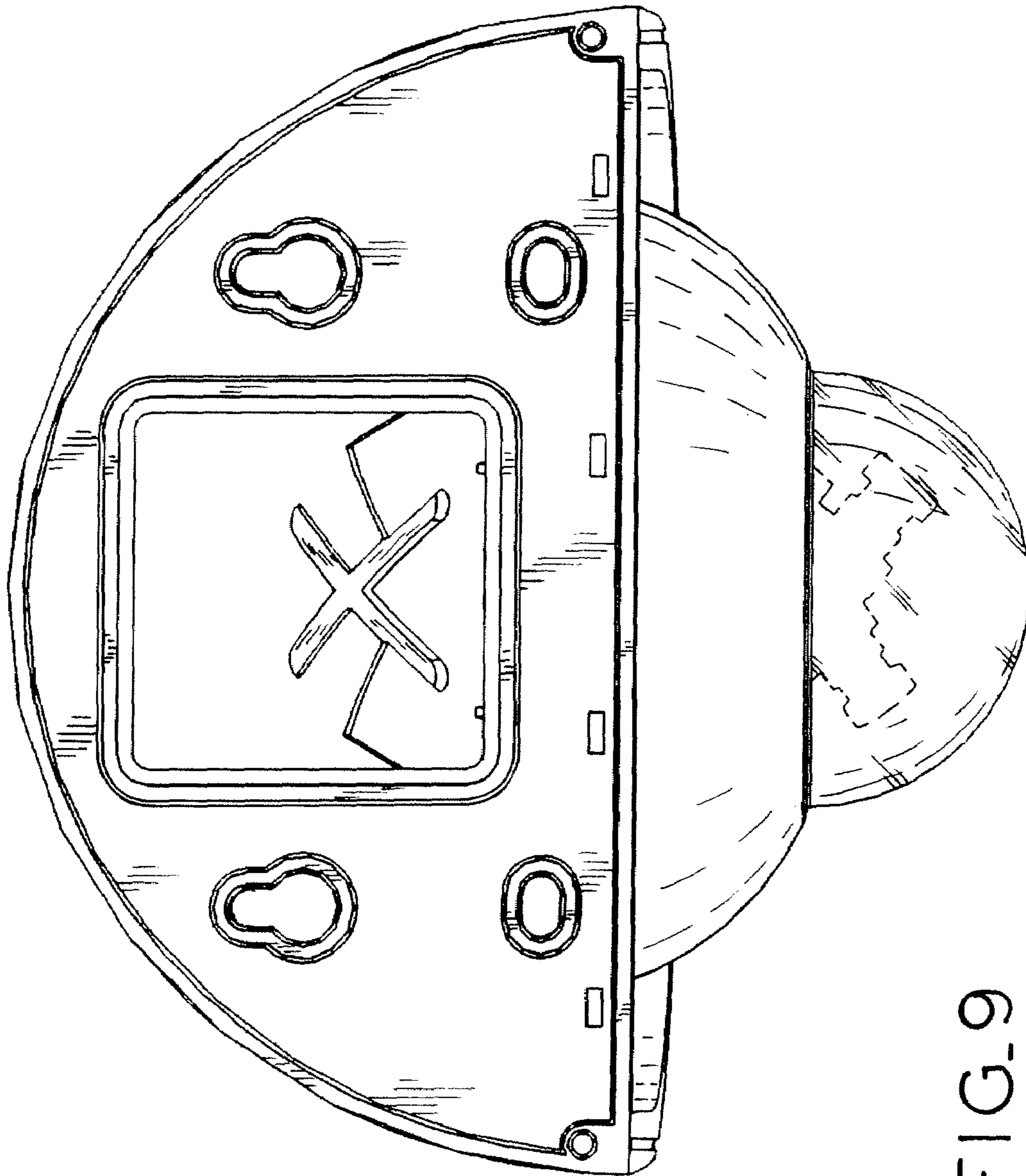

FIG. 9

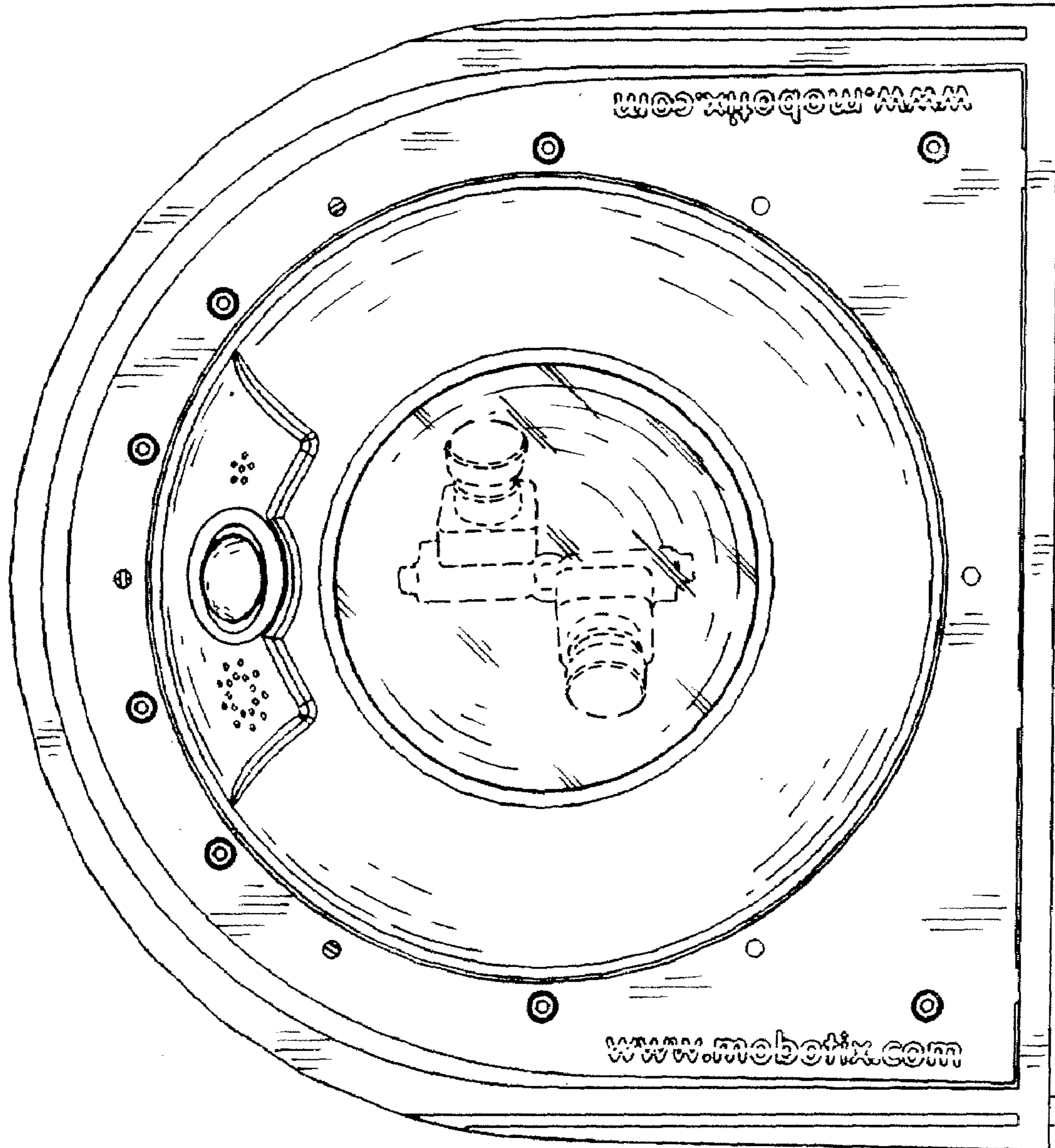

FIG. 10

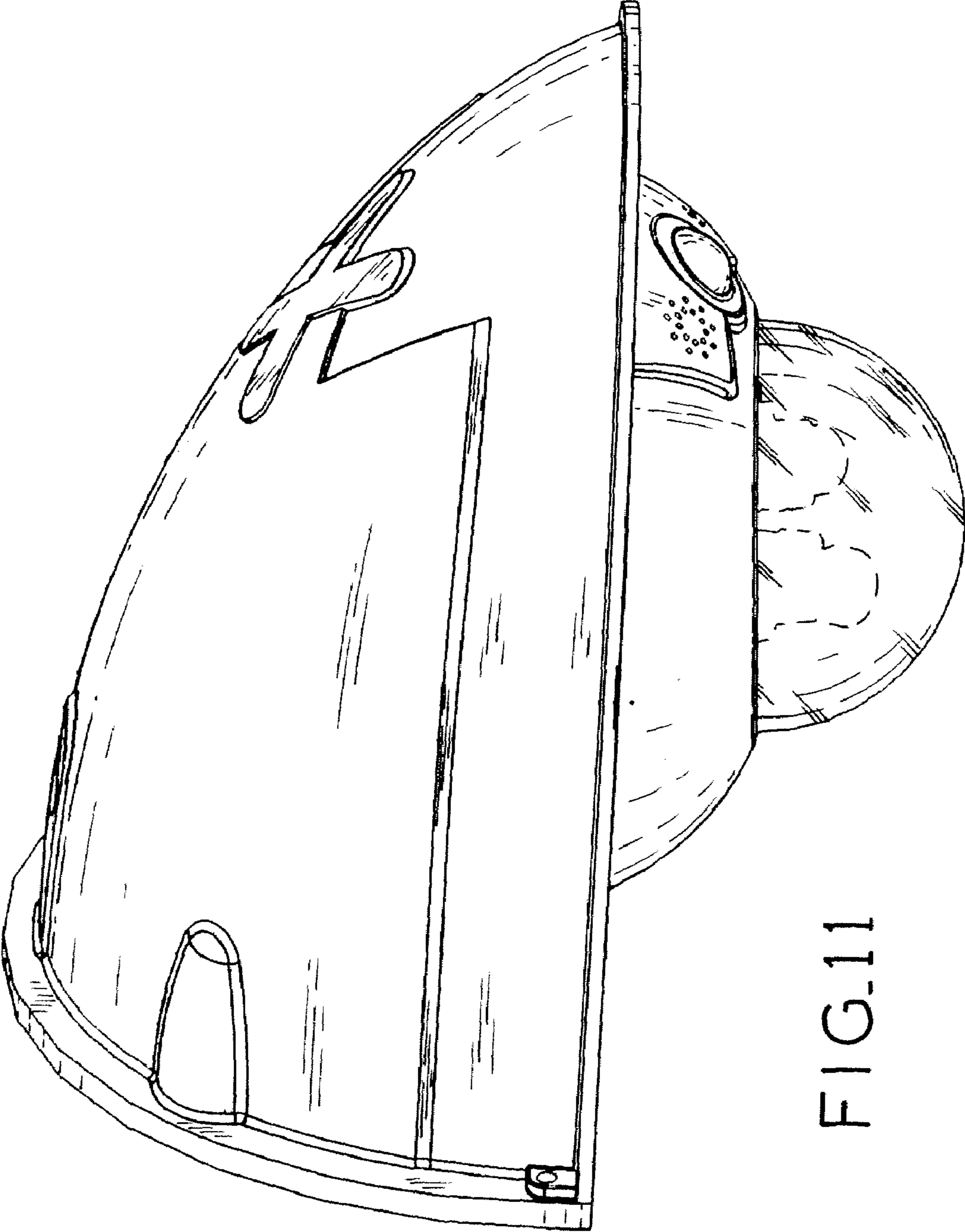

FIG.11

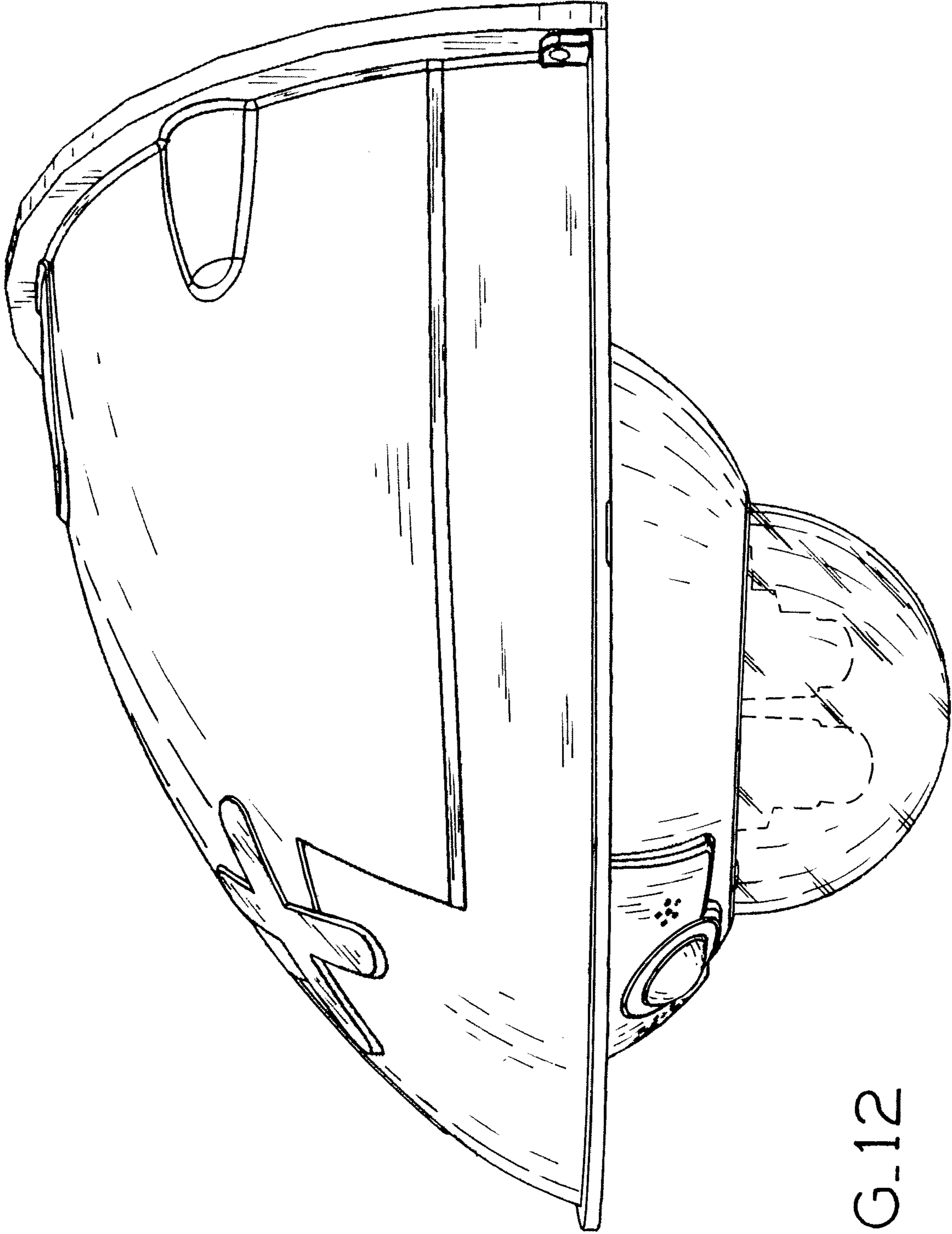

FIG.12

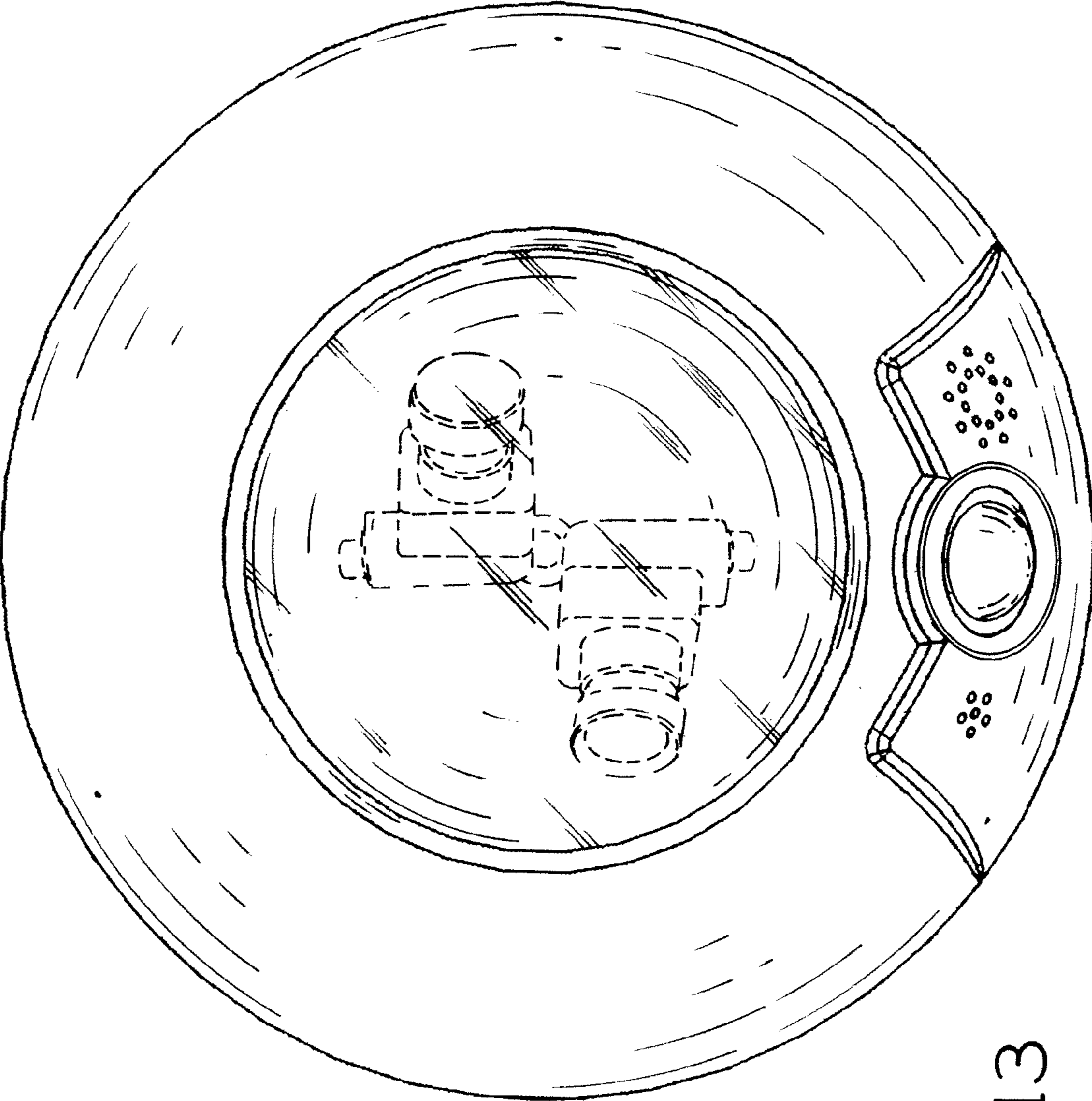

FIG. 13

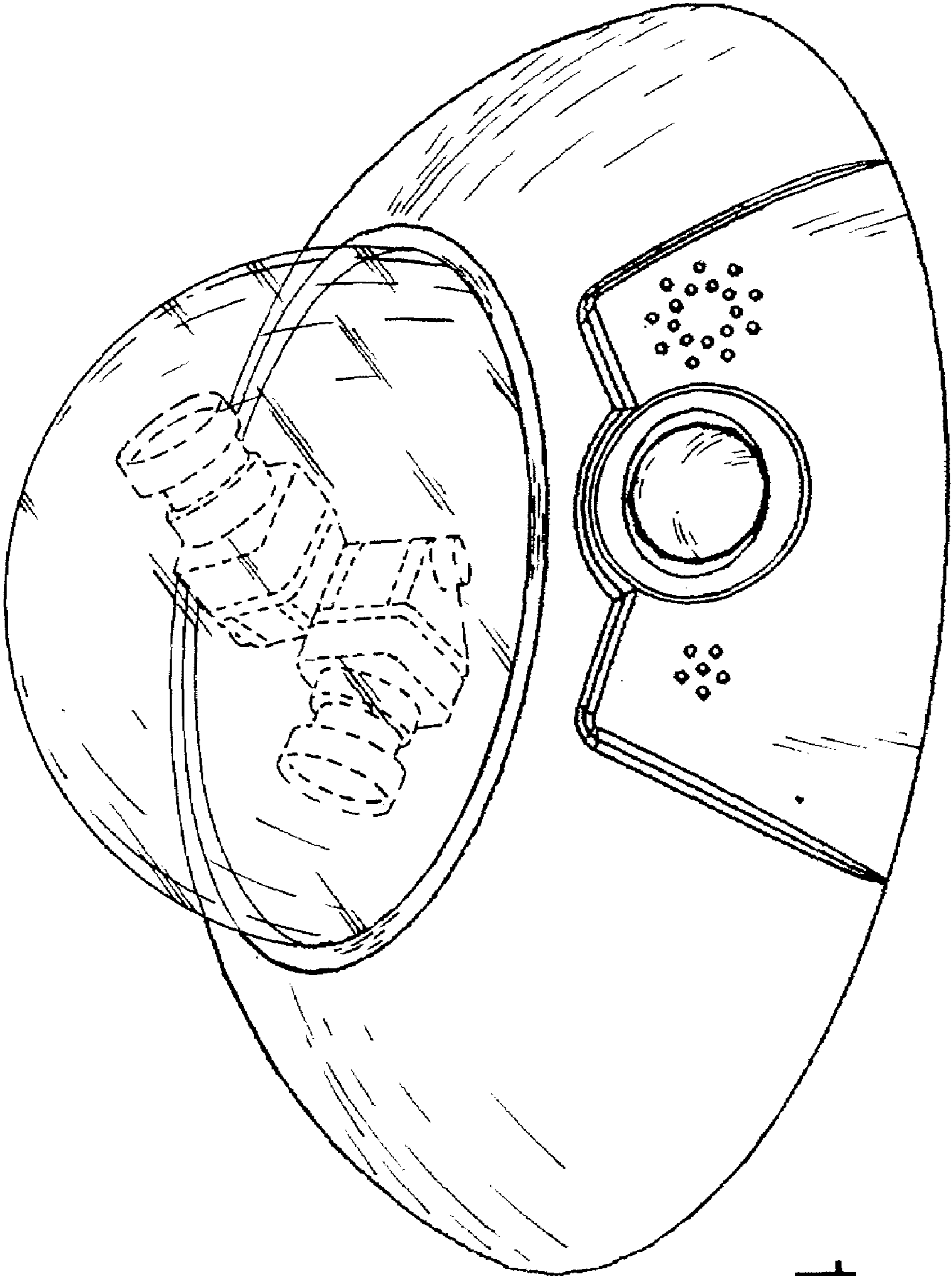

FIG.14

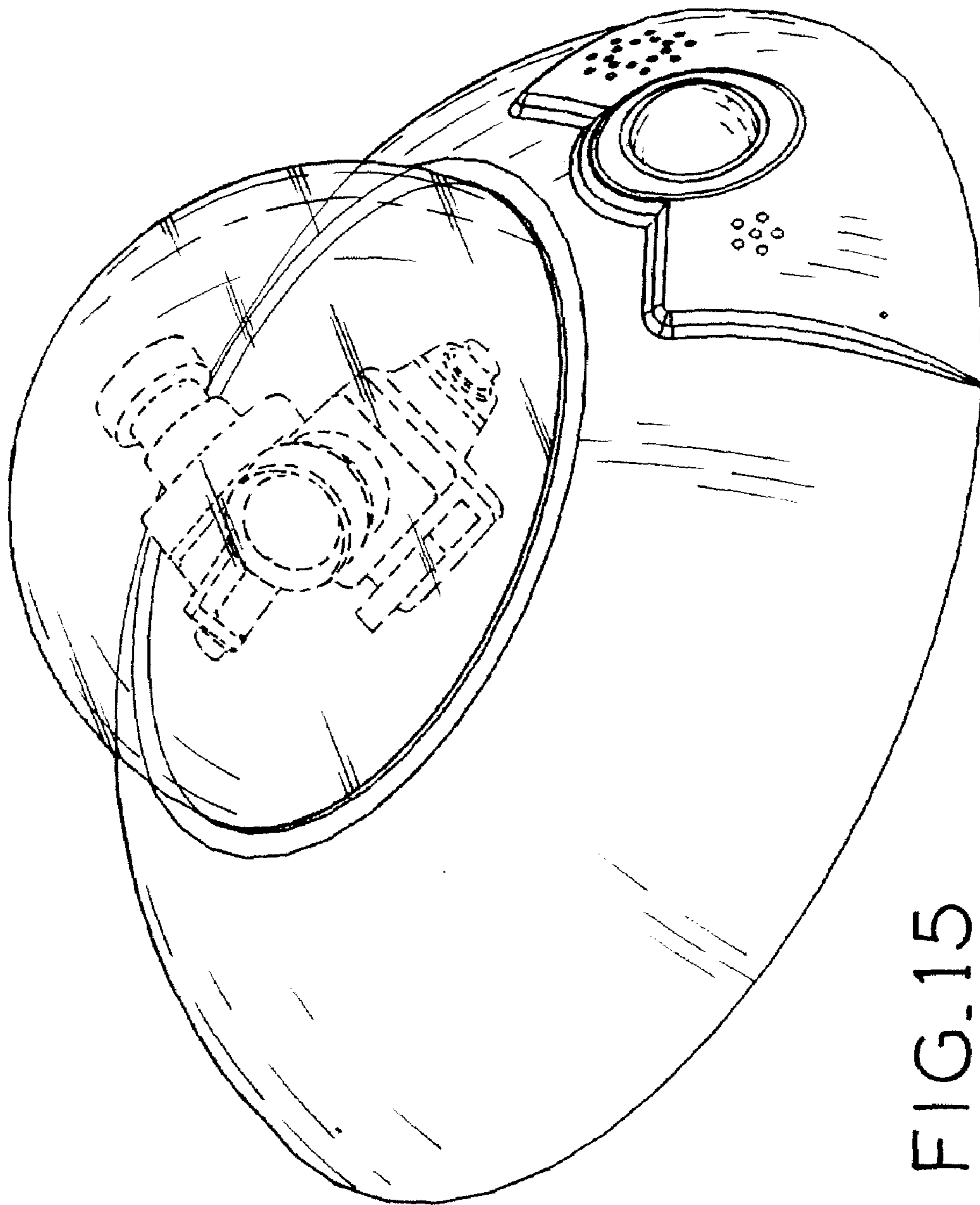

FIG. 15

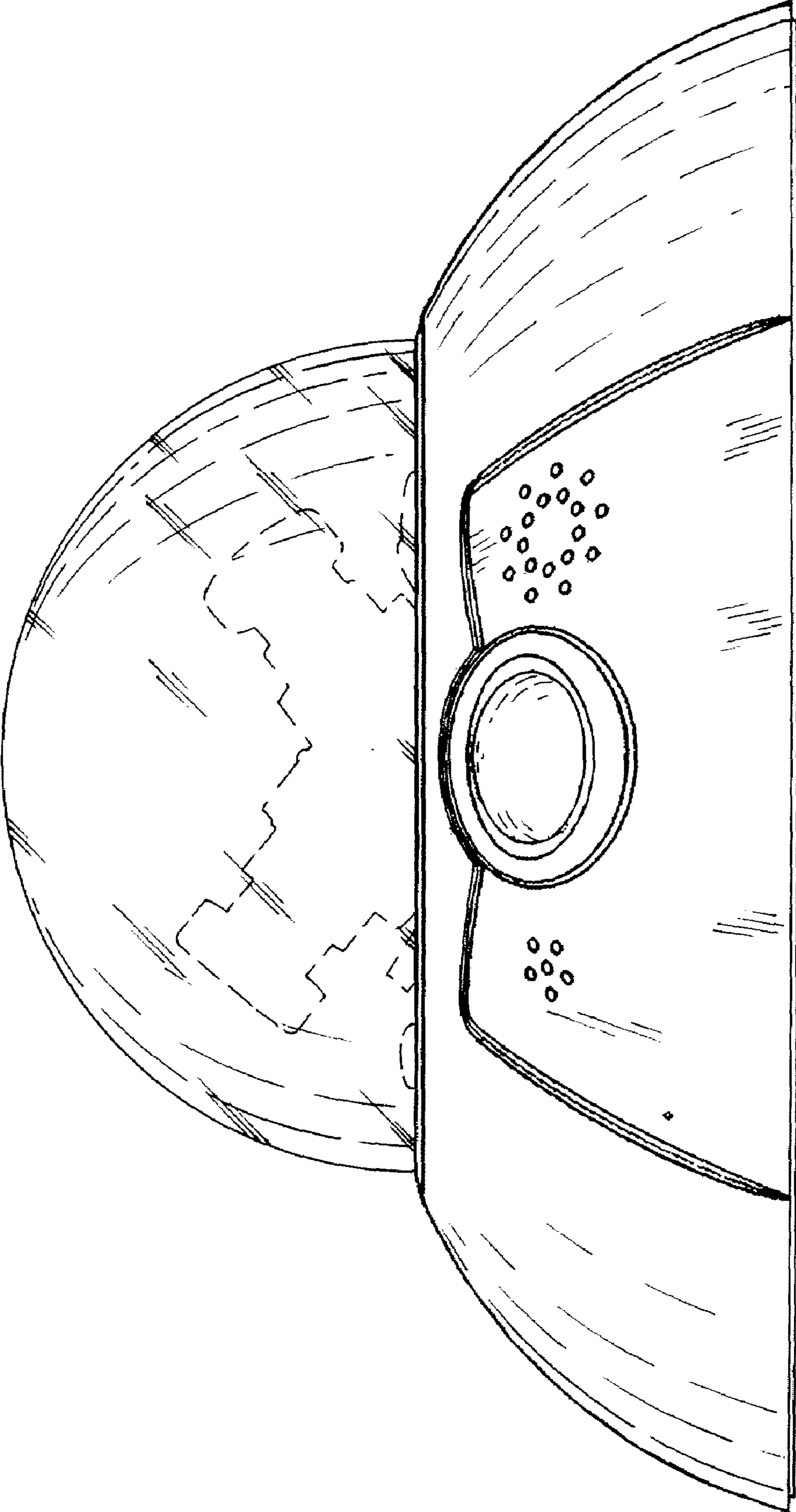

FIG. 16

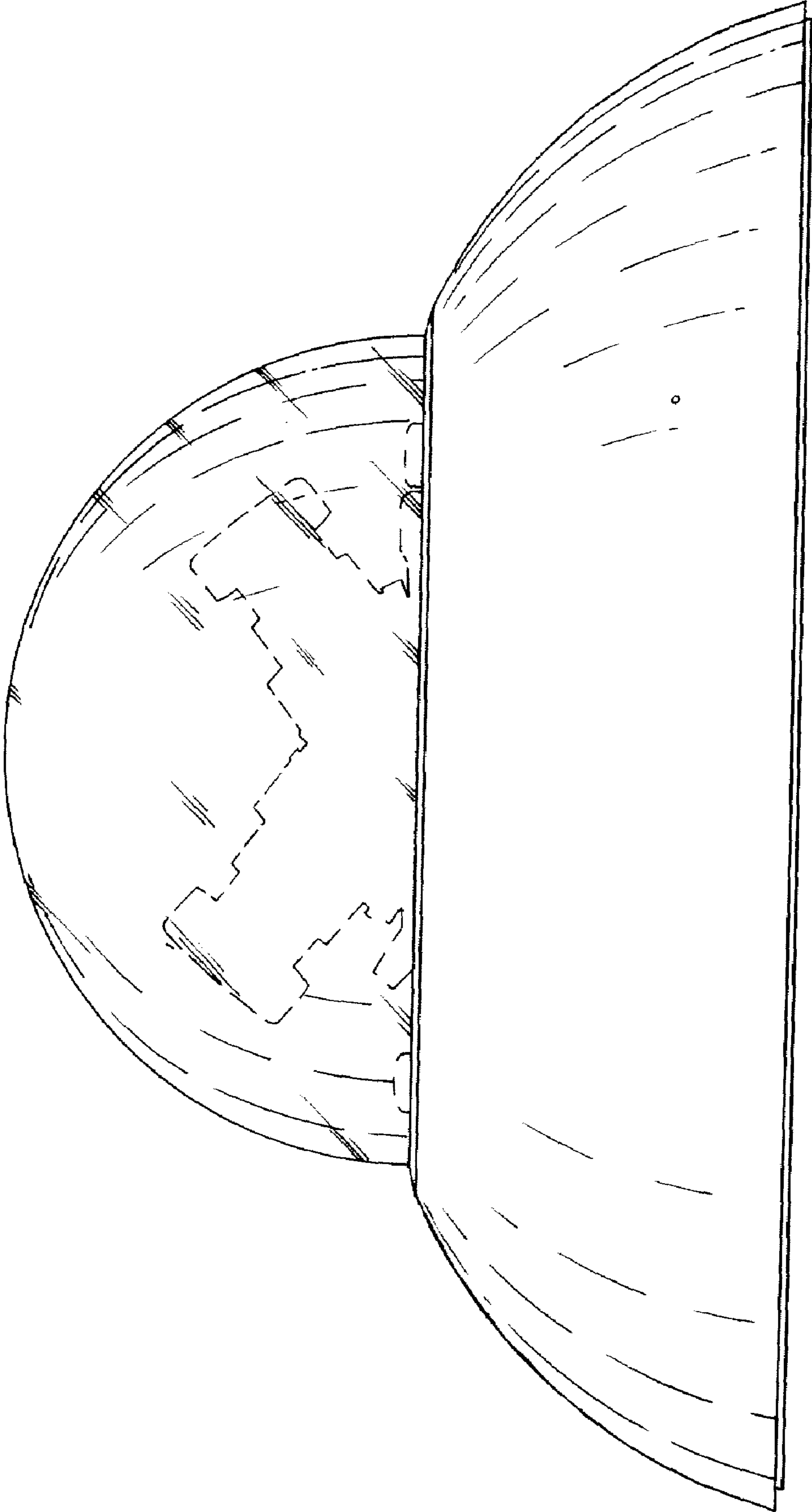

FIG. 17

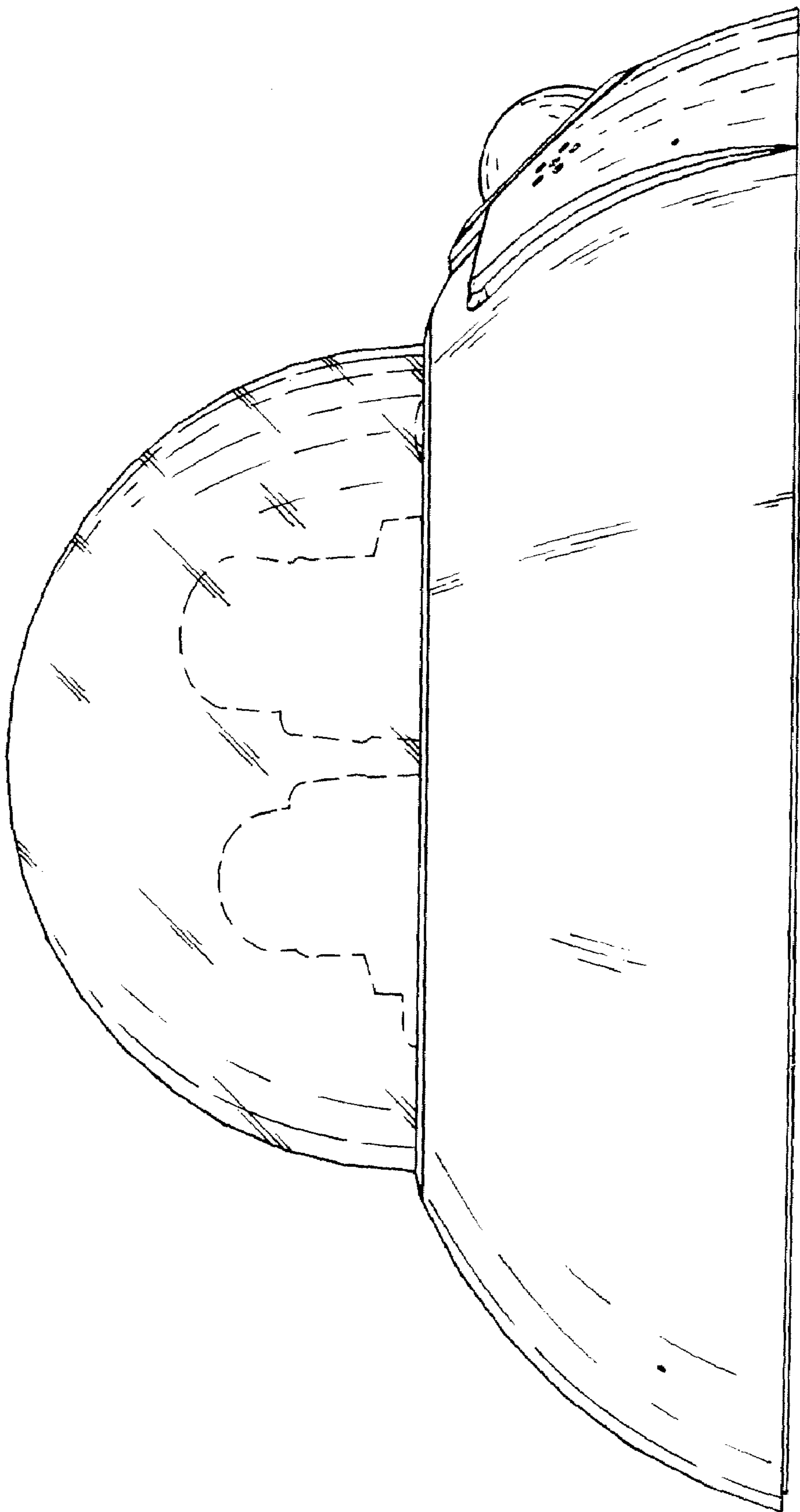

FIG. 18

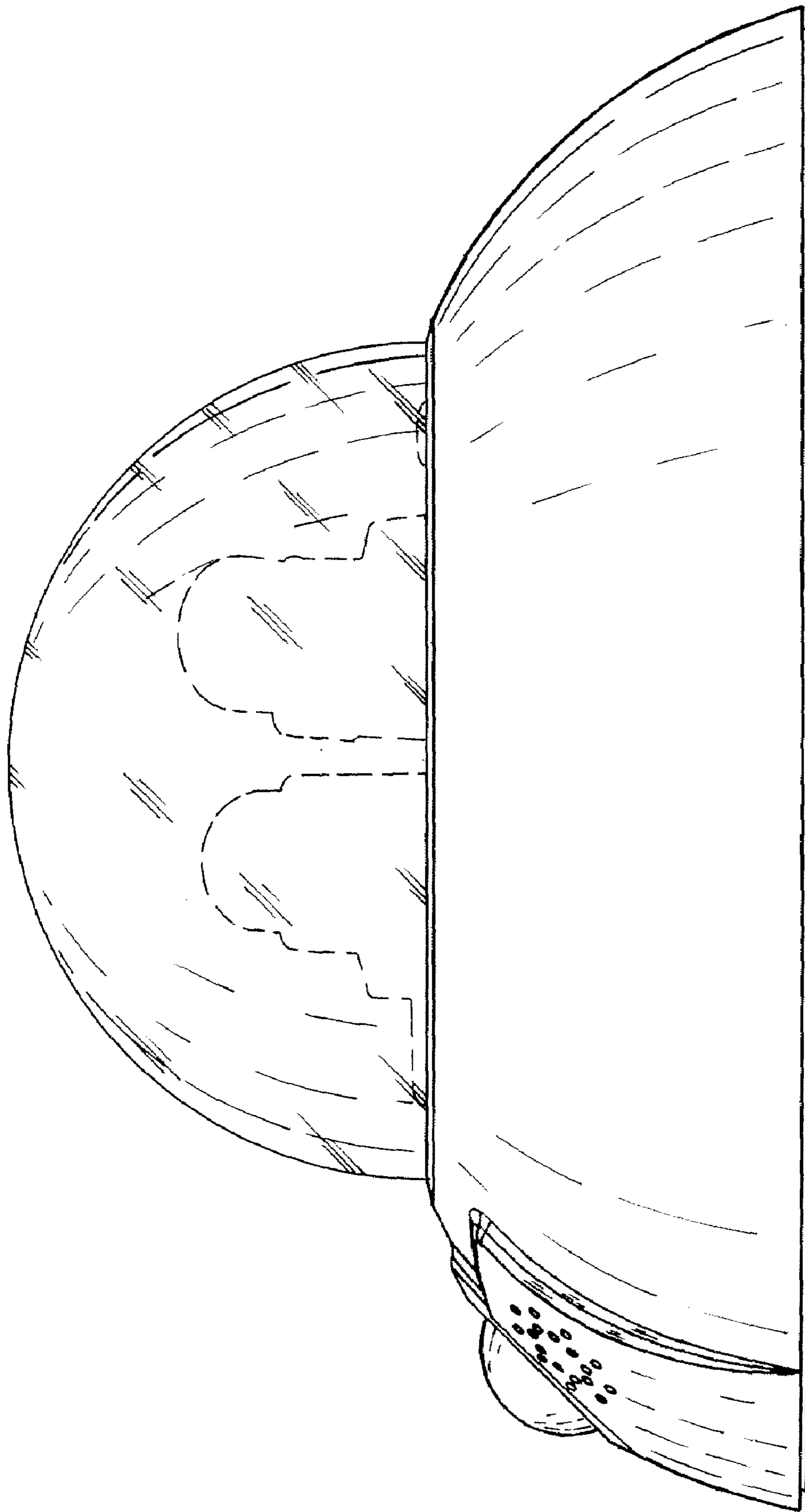

FIG.19

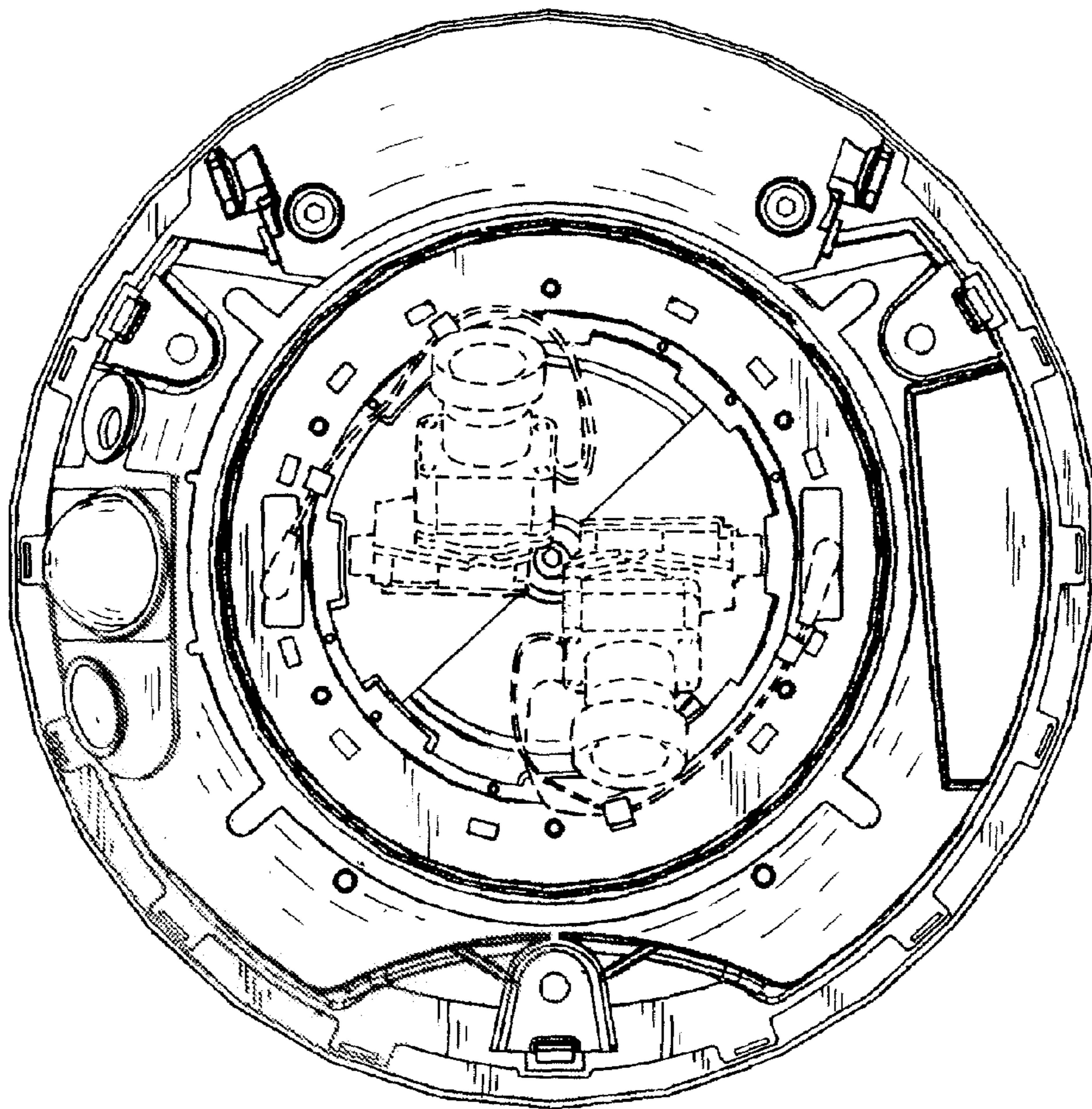

FIG. 20

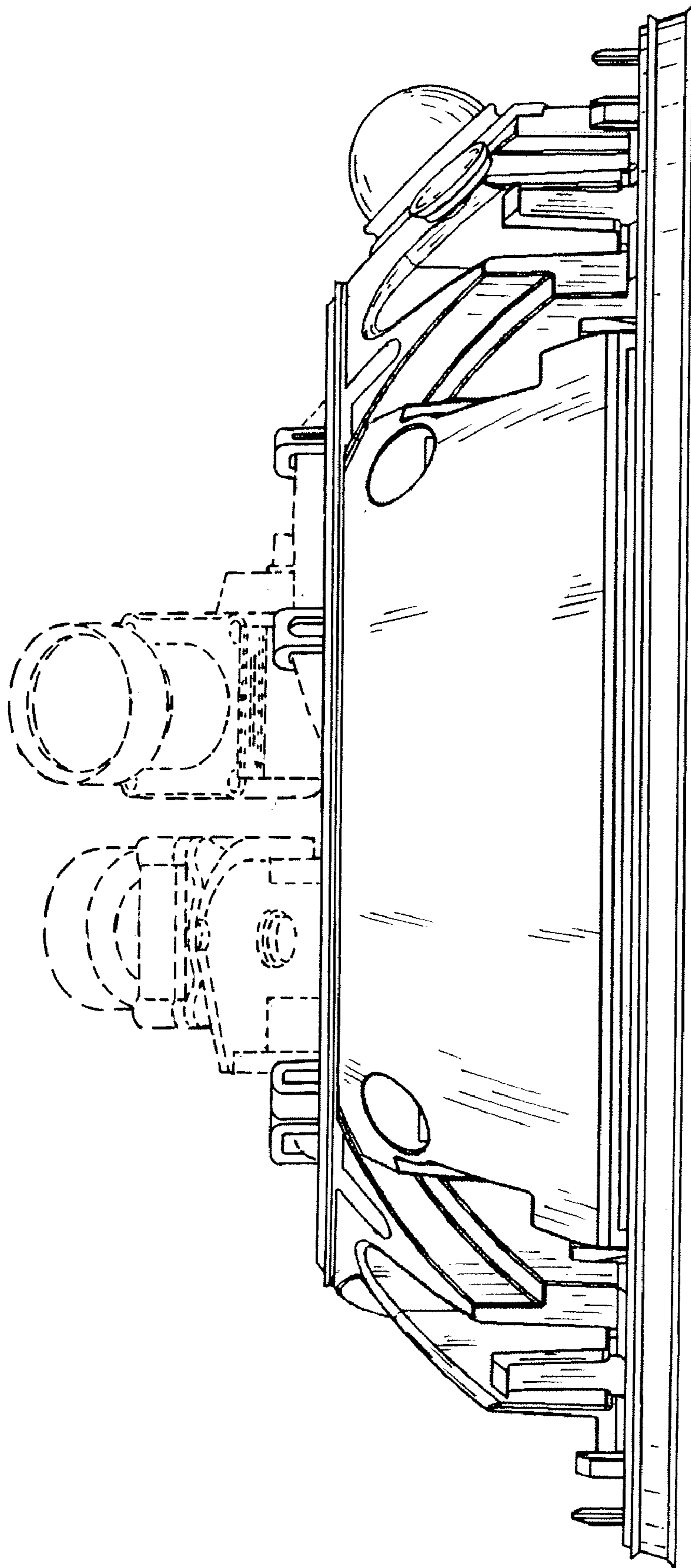

FIG. 21

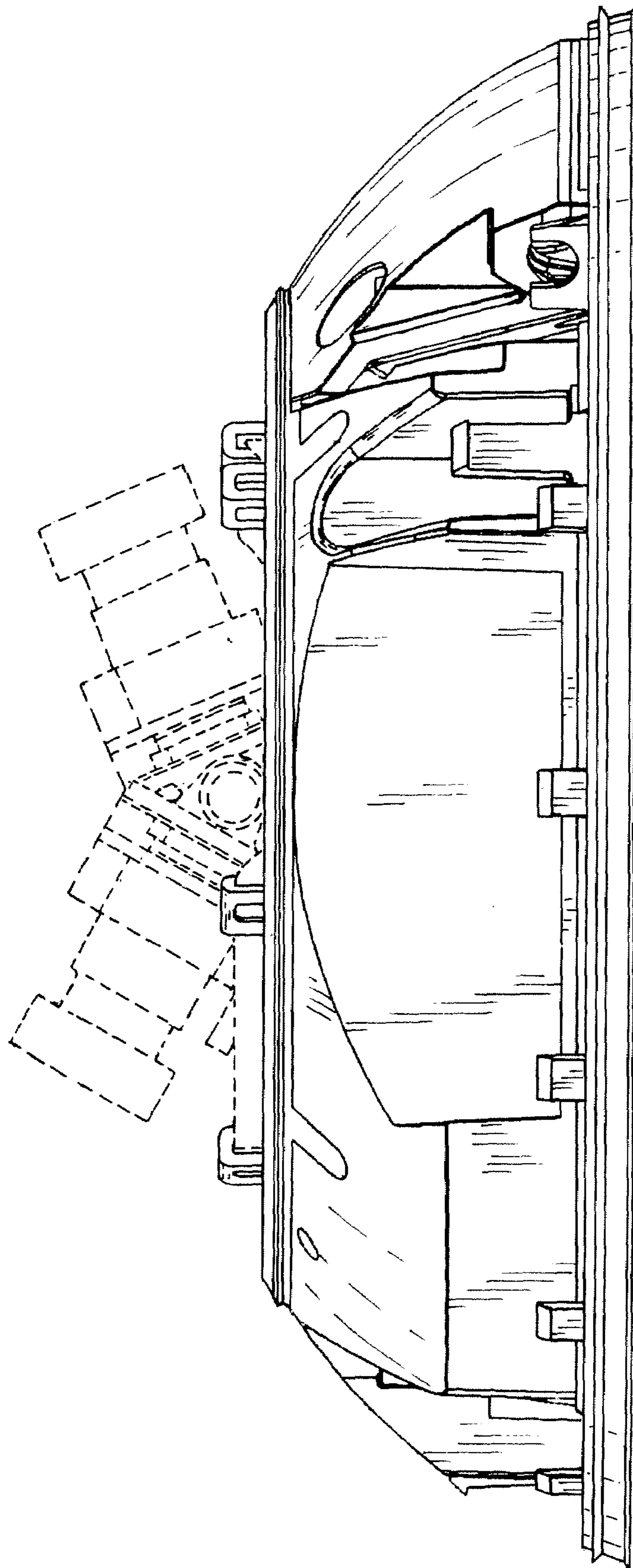

FIG. 22

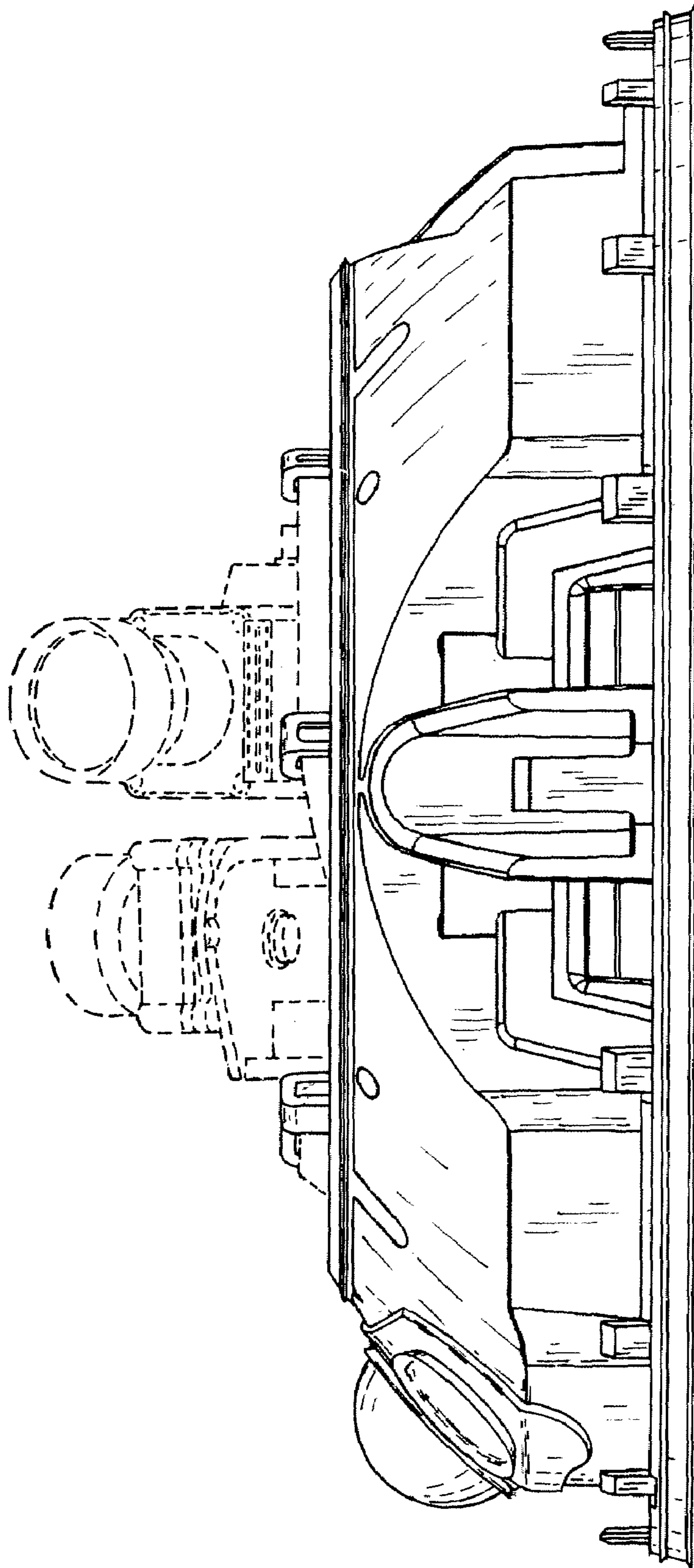

FIG. 23

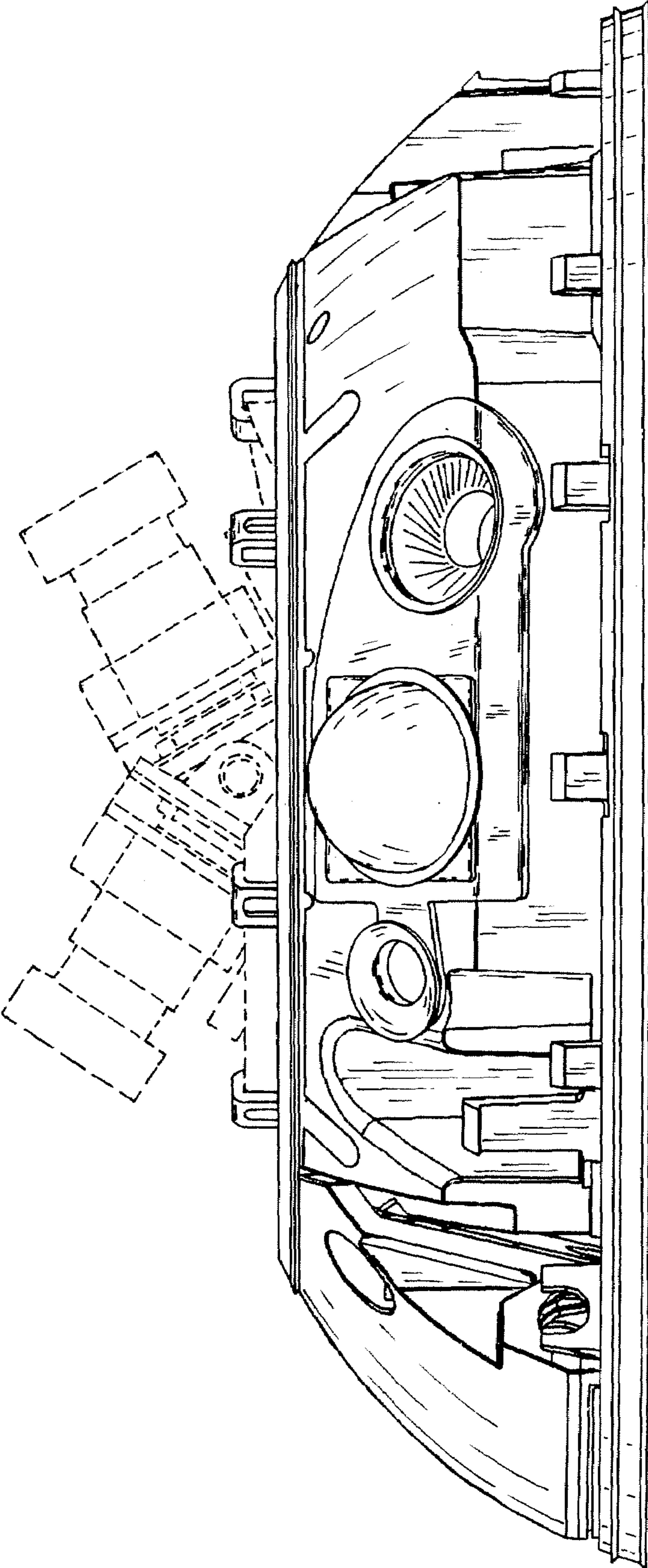

FIG.24

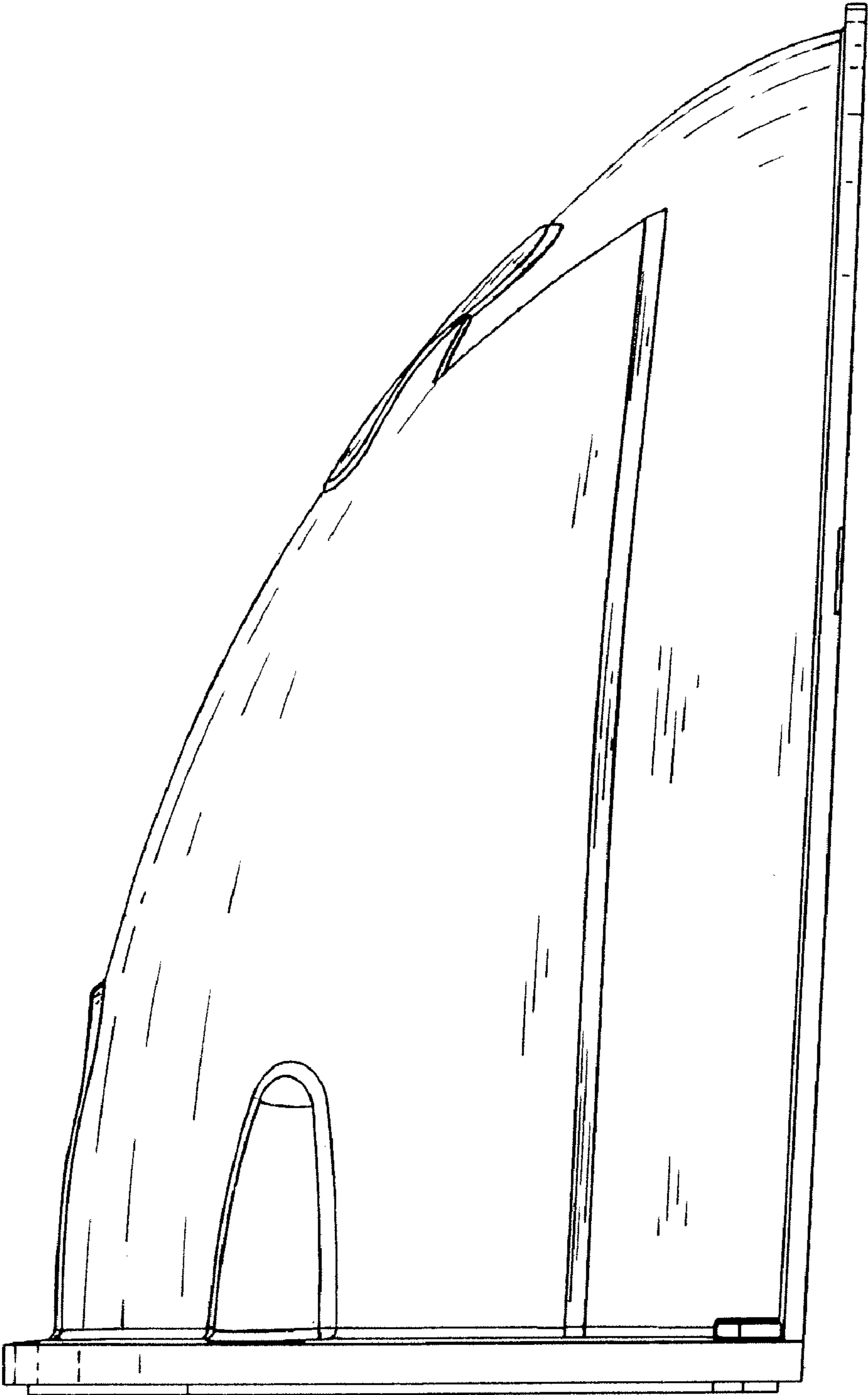

FIG. 25

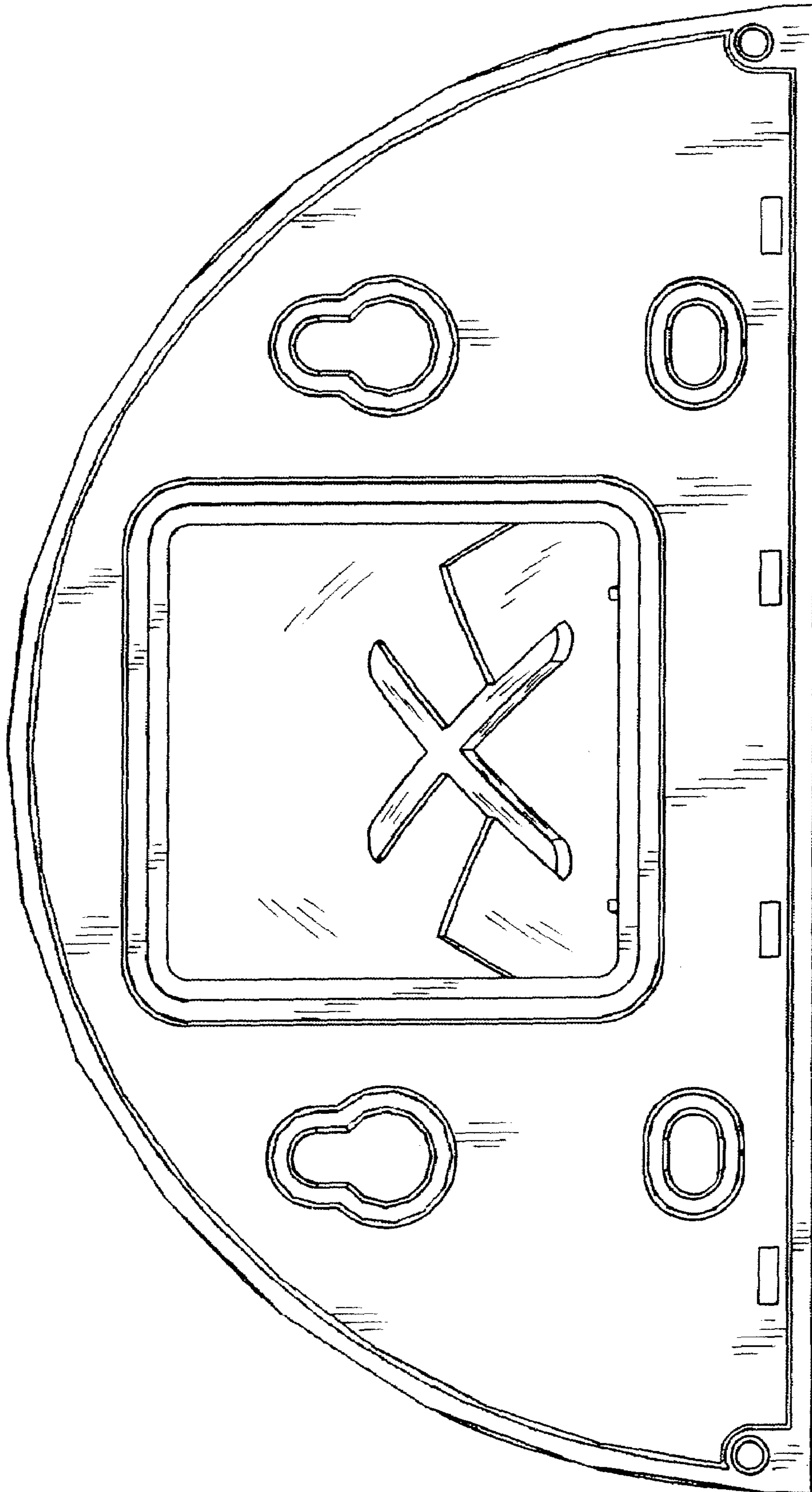

FIG. 26

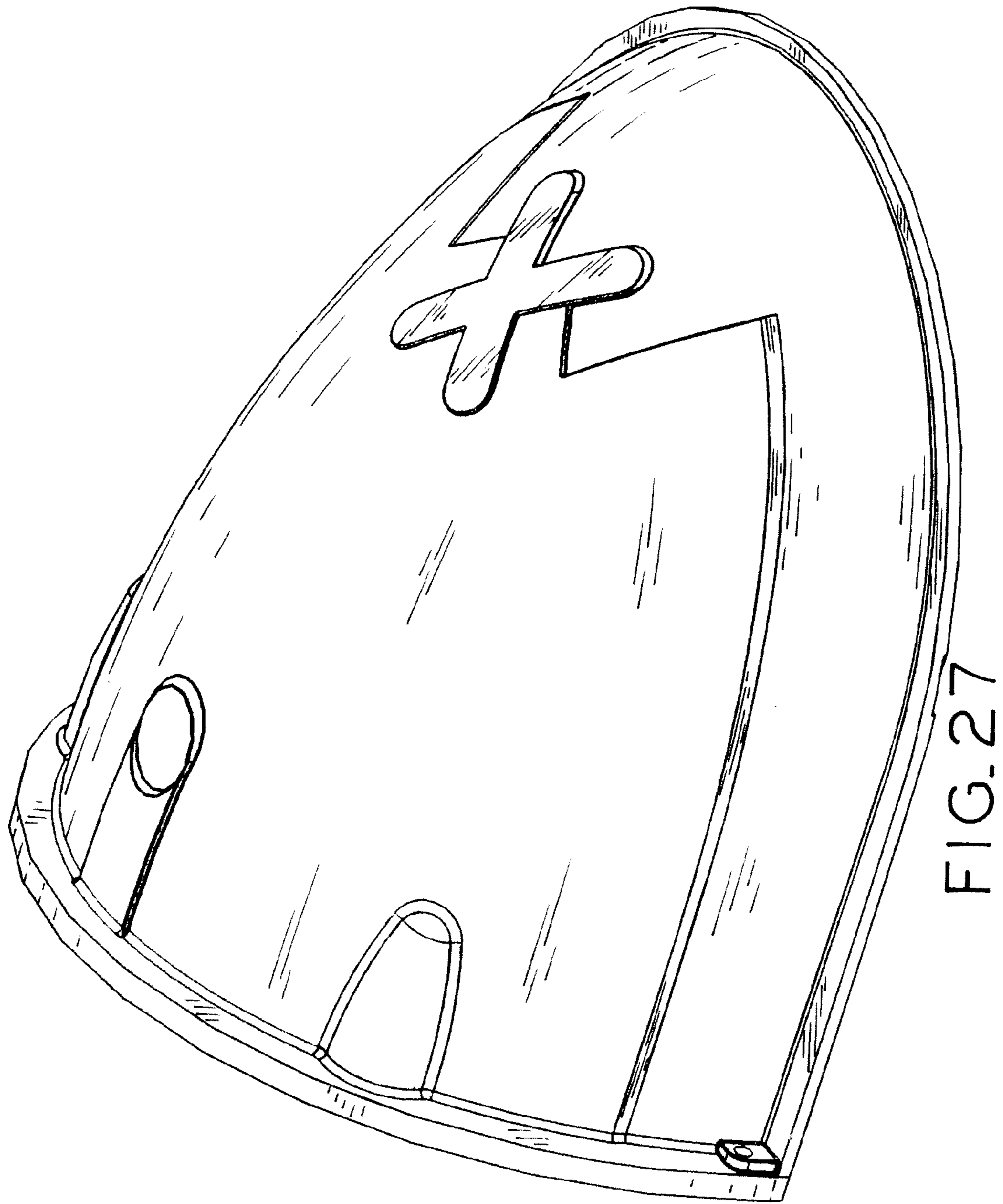

FIG. 27

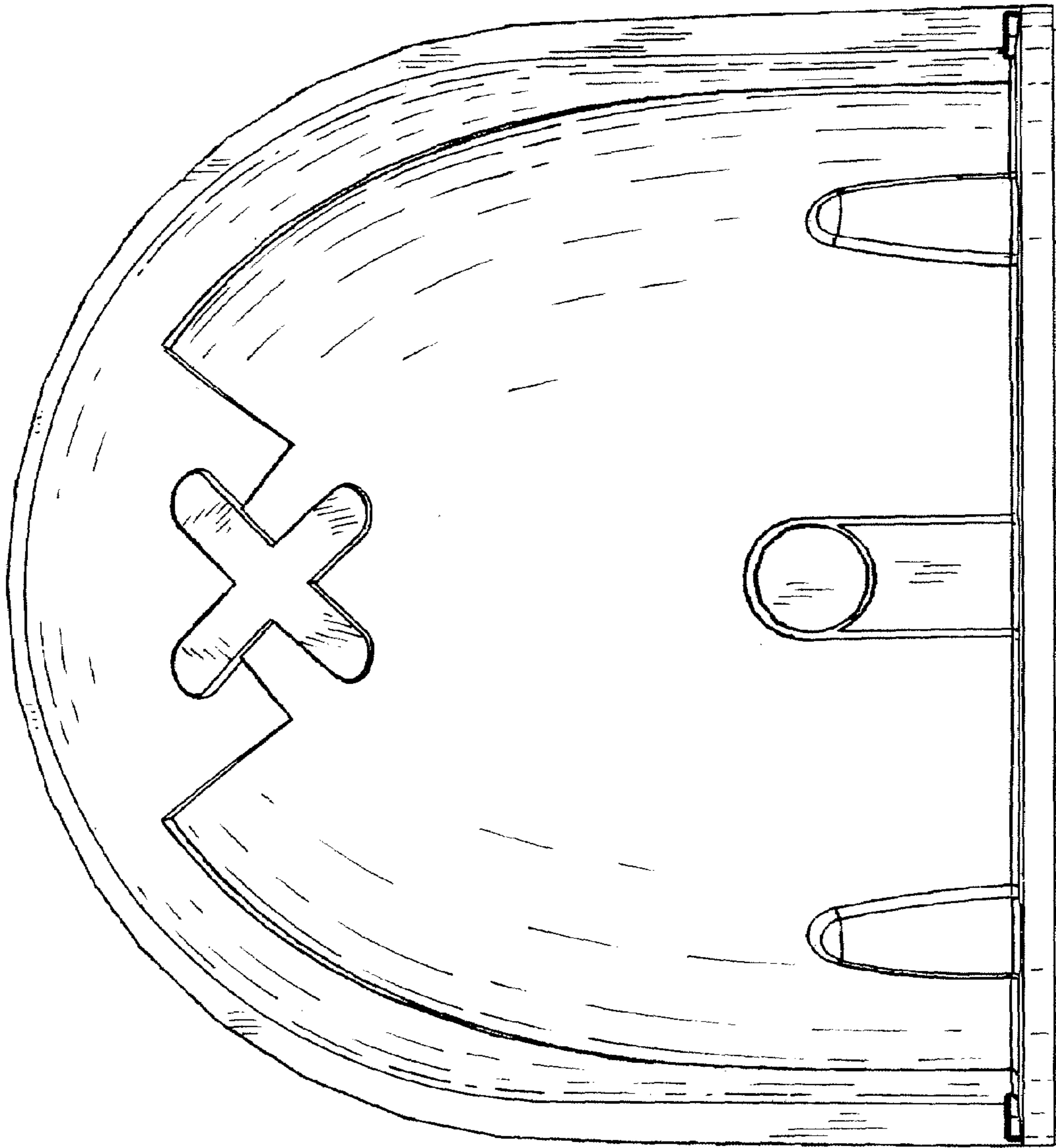

FIG. 28

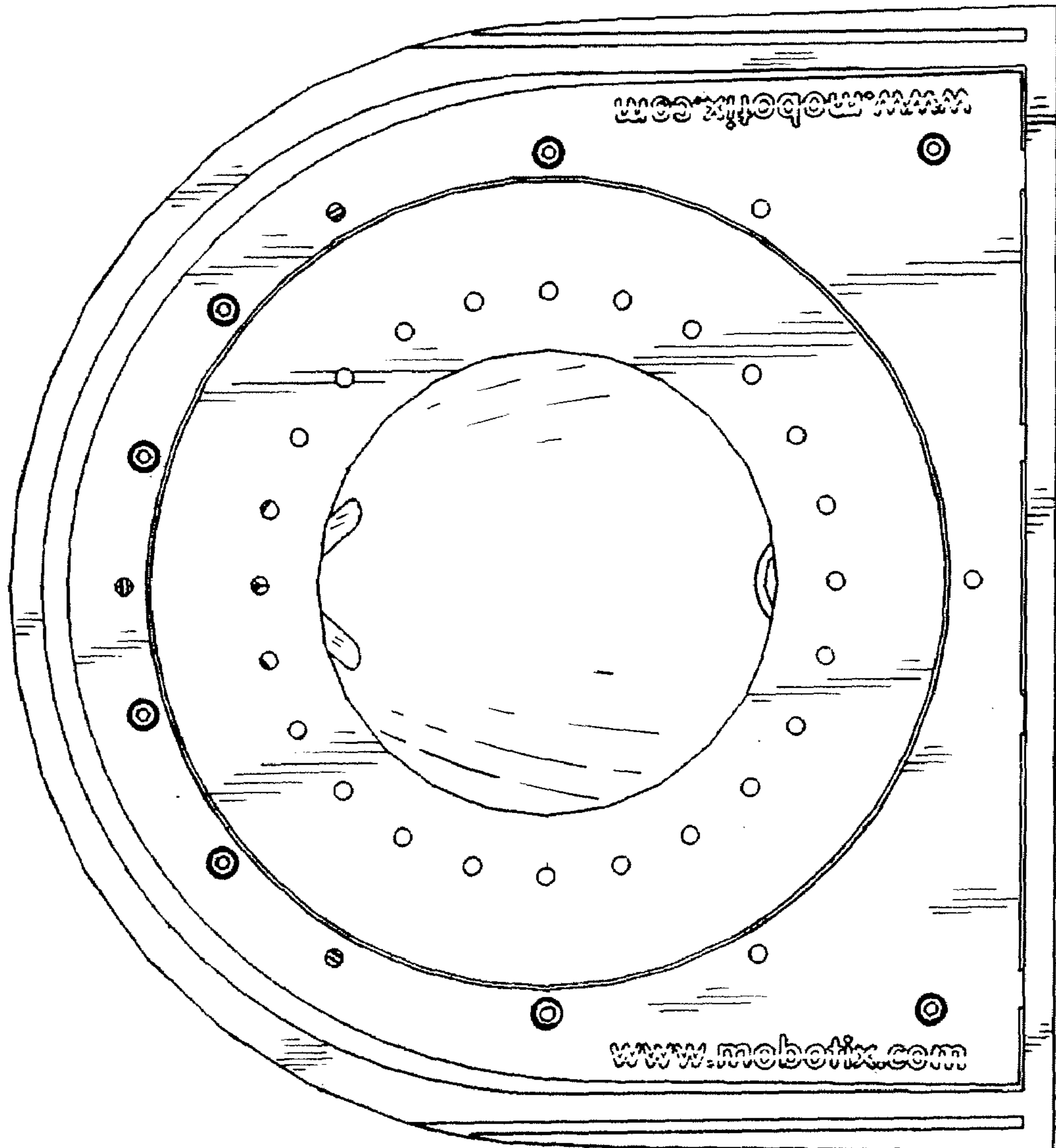

FIG. 29

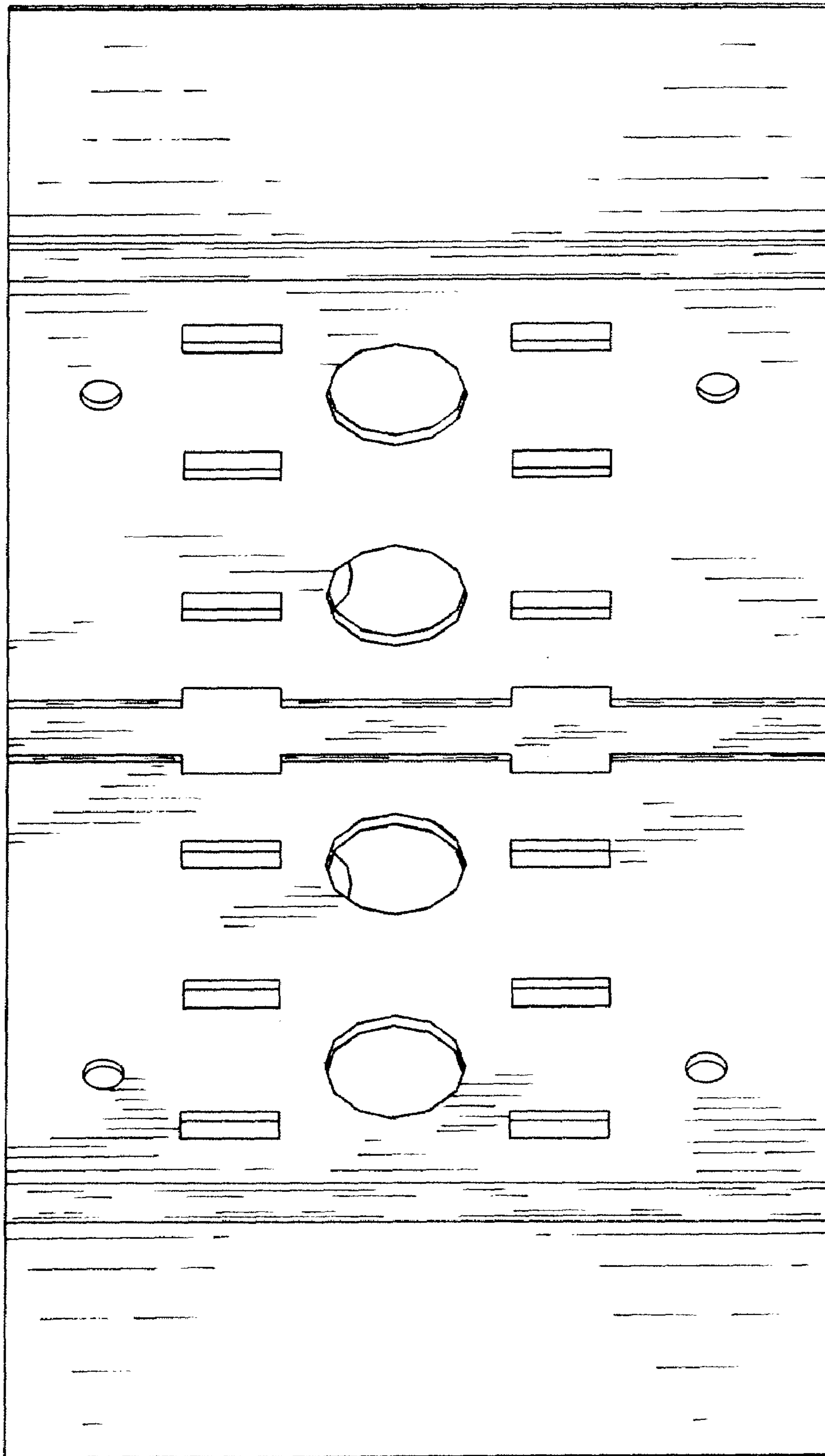

FIG. 30

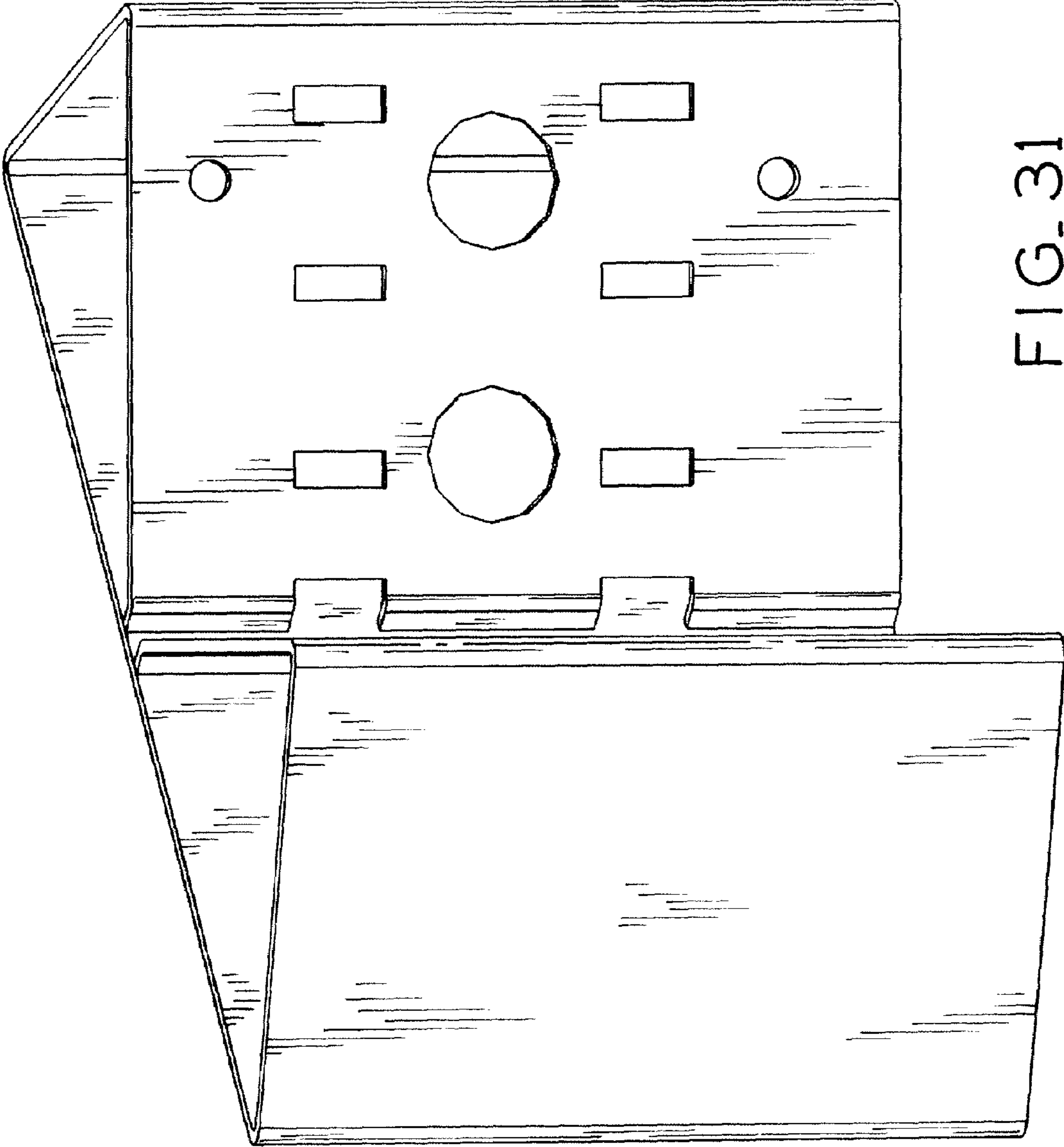

FIG. 31

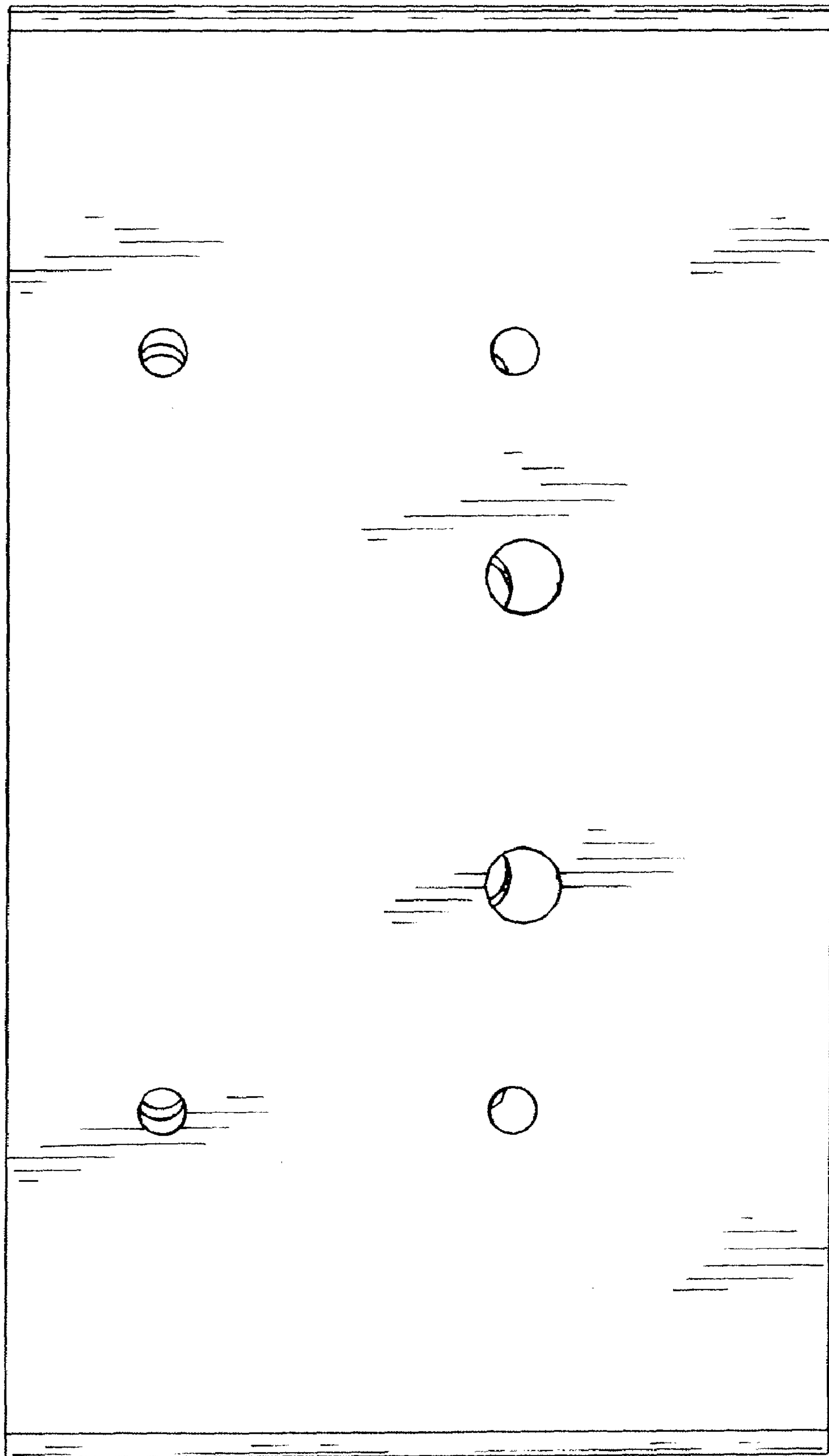

FIG. 32

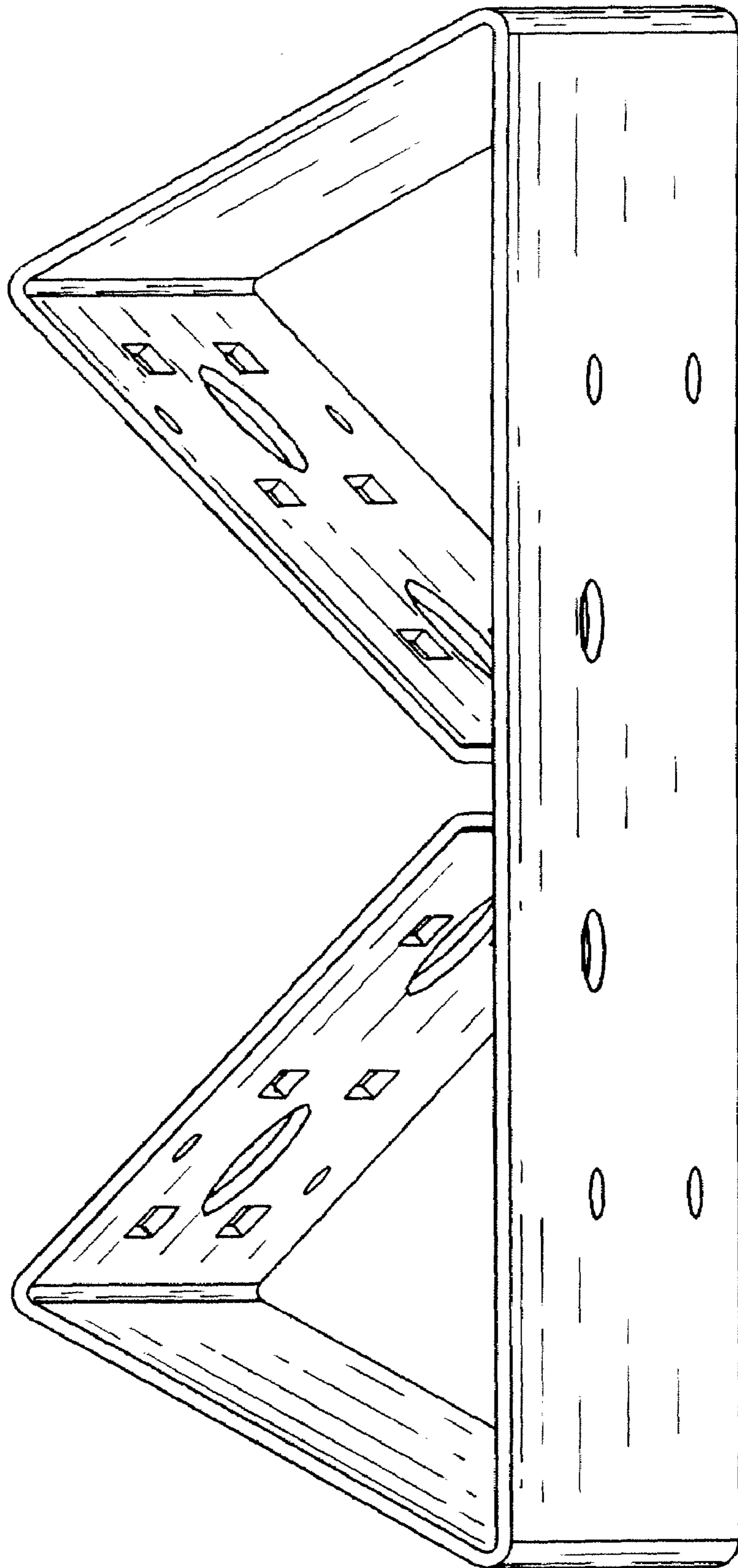

FIG. 33