



US00D606048S

(12) **United States Design Patent**
Soetejo et al.

(10) **Patent No.:** **US D606,048 S**

(45) **Date of Patent:** **** Dec. 15, 2009**

(54) **EARPHONE**

(75) Inventors: **Juarsa Soetejo**, Singapore (SG); **Huang Pheng Vince Ang**, Singapore (SG); **Hui Ling Gan**, Singapore (SG); **Mingliang Chong**, Singapore (SG)

(73) Assignee: **Creative Technology Ltd**, Singapore (SG)

(**) Term: **14 Years**

(21) Appl. No.: **29/325,881**

(22) Filed: **Oct. 7, 2008**

(51) **LOC (9) Cl.** **14-01**

(52) **U.S. Cl.** **D14/223**

(58) **Field of Classification Search** D14/188,
D14/192, 205, 206, 223; 181/129, 130; 381/330,
381/374, 375, 370, 376-381, 385, 379
See application file for complete search history.

(56) **References Cited**

U.S. PATENT DOCUMENTS

3,692,958	A *	9/1972	Dymoke	379/430
4,073,366	A *	2/1978	Estes	181/158
4,335,281	A *	6/1982	Scott et al.	379/430
D272,904	S *	3/1984	Kawano	D14/205
4,453,050	A *	6/1984	Enokido	381/381
D284,859	S *	7/1986	Okada	D14/192
4,677,675	A *	6/1987	Killion et al.	381/322
D293,107	S *	12/1987	Muller	D14/205
4,917,504	A *	4/1990	Scott et al.	381/381
D326,653	S *	6/1992	Hino	D14/192

5,210,792	A *	5/1993	Kajihara	379/430
5,410,608	A *	4/1995	Lucey et al.	381/360
5,412,736	A *	5/1995	Keliiliki	381/381
5,450,496	A *	9/1995	Burris et al.	381/375
5,655,026	A *	8/1997	Peters et al.	381/385
6,101,260	A *	8/2000	Jensen et al.	381/381
D460,749	S *	7/2002	Liu	D14/206
D538,792	S *	3/2007	Kim et al.	D14/223
D539,787	S *	4/2007	Kim et al.	D14/223
D542,267	S *	5/2007	Cha et al.	D14/206
D556,735	S *	12/2007	Yeo	D14/206

* cited by examiner

Primary Examiner—Paula Greene

(74) *Attorney, Agent, or Firm*—Kennedy Koblin

(57) **CLAIM**

The ornamental design for an earphone, substantially as shown and described.

DESCRIPTION

FIG. 1 is a perspective view of the earphone in accordance with the present design;

FIG. 2 is a front view of the earphone shown in FIG. 1;

FIG. 3 is a back view of the earphone shown in FIG. 1;

FIG. 4 is a left view of the earphone shown in FIG. 1;

FIG. 5 is a right view of the earphone shown in FIG. 1;

FIG. 6 is a top view of the earphone shown in FIG. 1; and,

FIG. 7 is a bottom view of the earphone shown in FIG. 1.

The broken lines form no part of the claimed design.

1 Claim, 4 Drawing Sheets

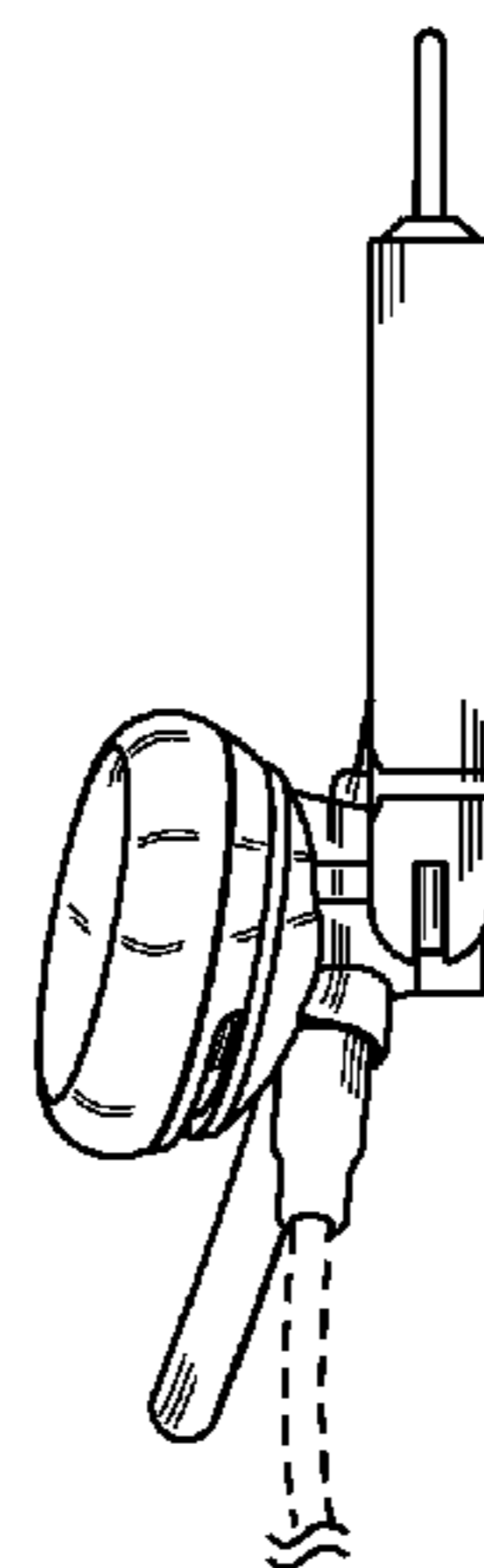
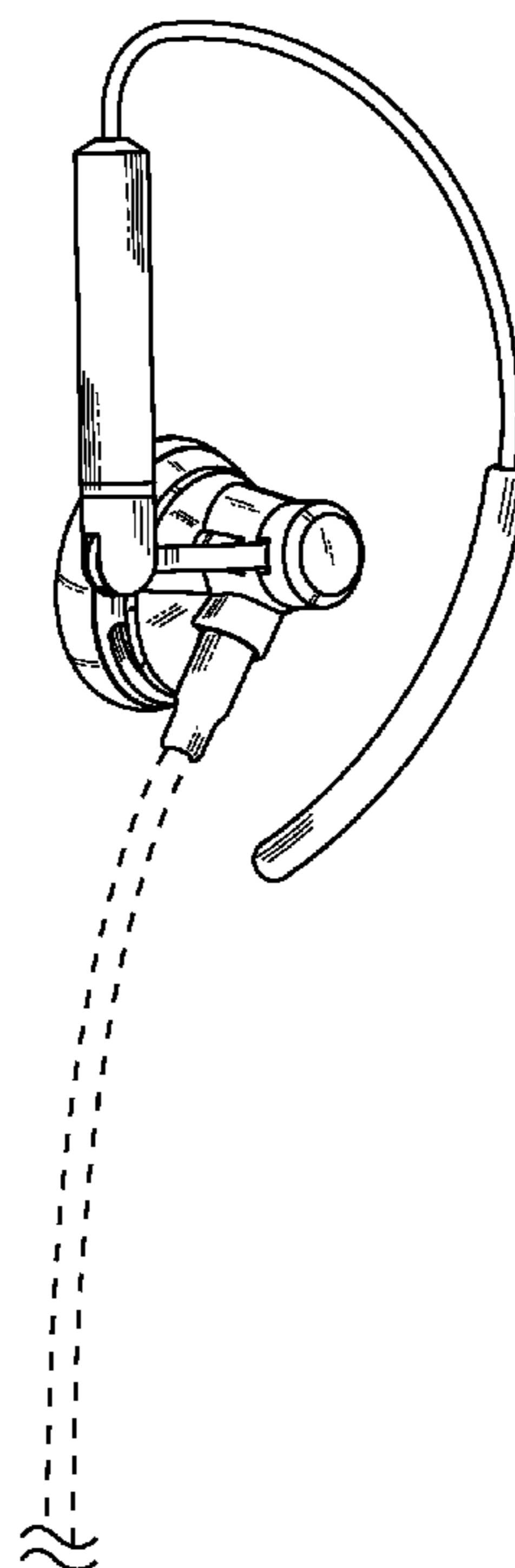

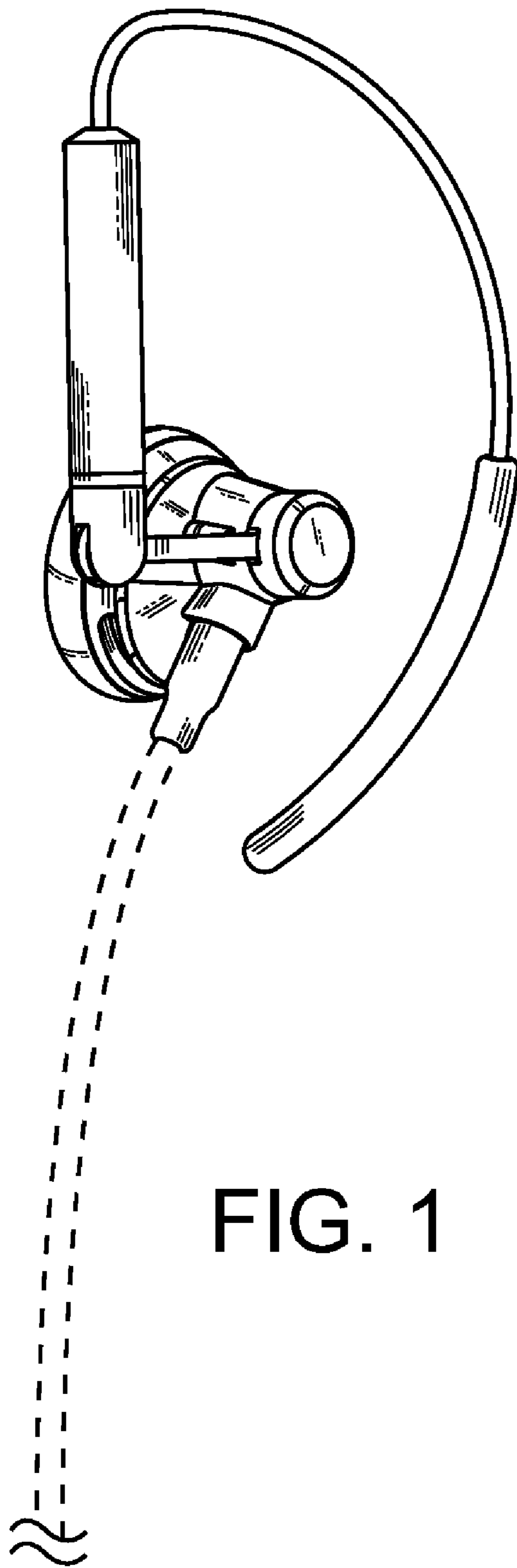
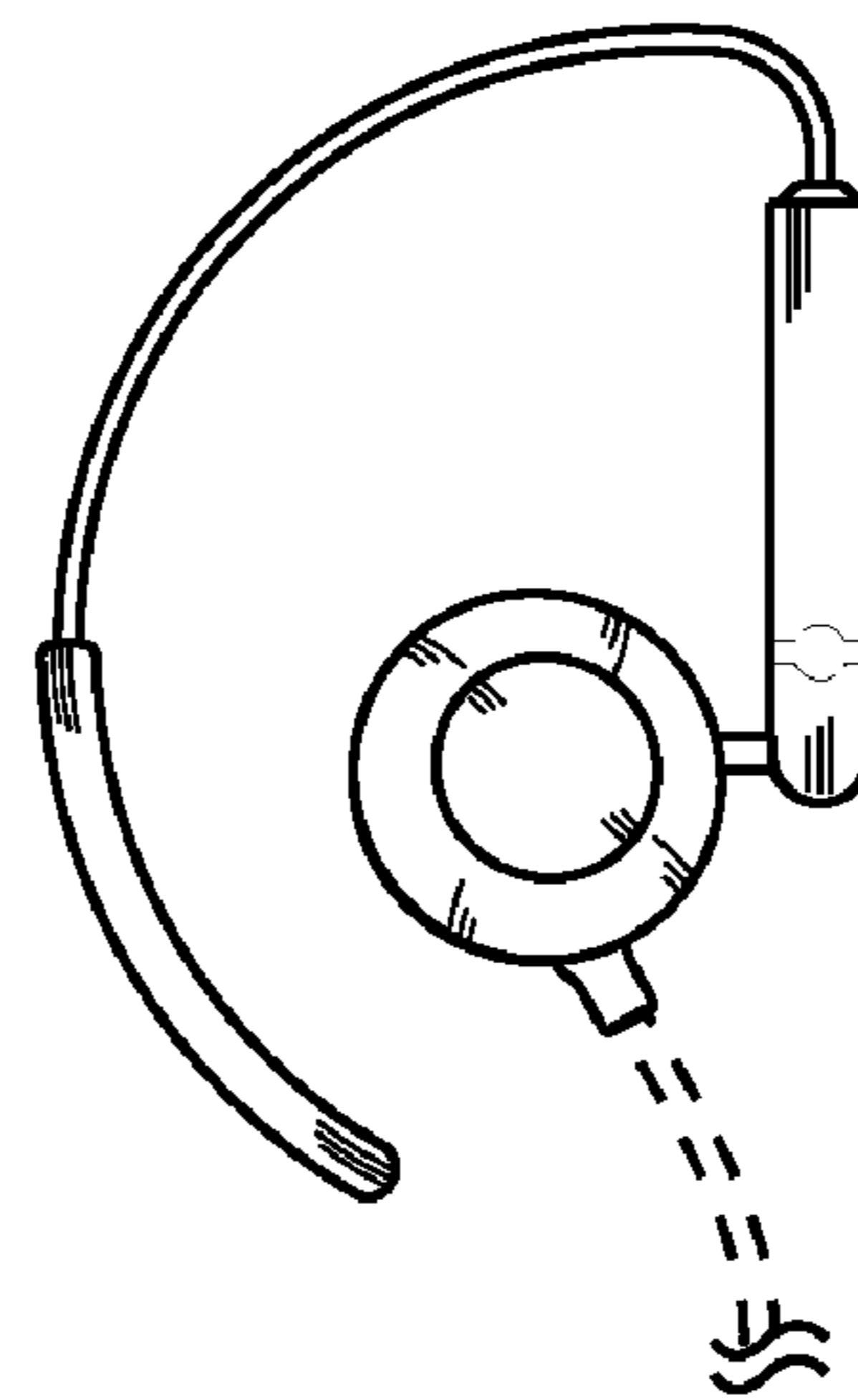
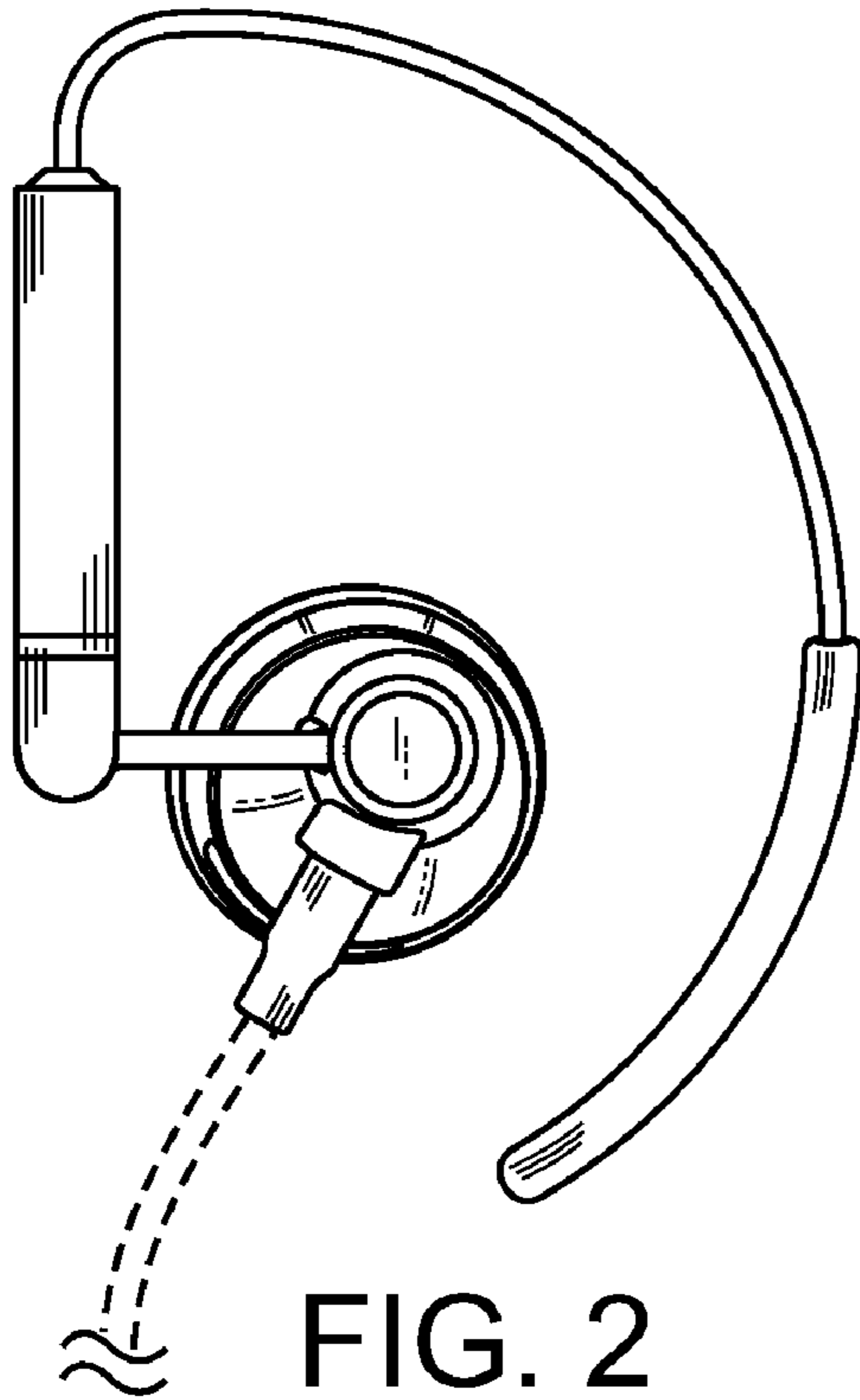

FIG. 1



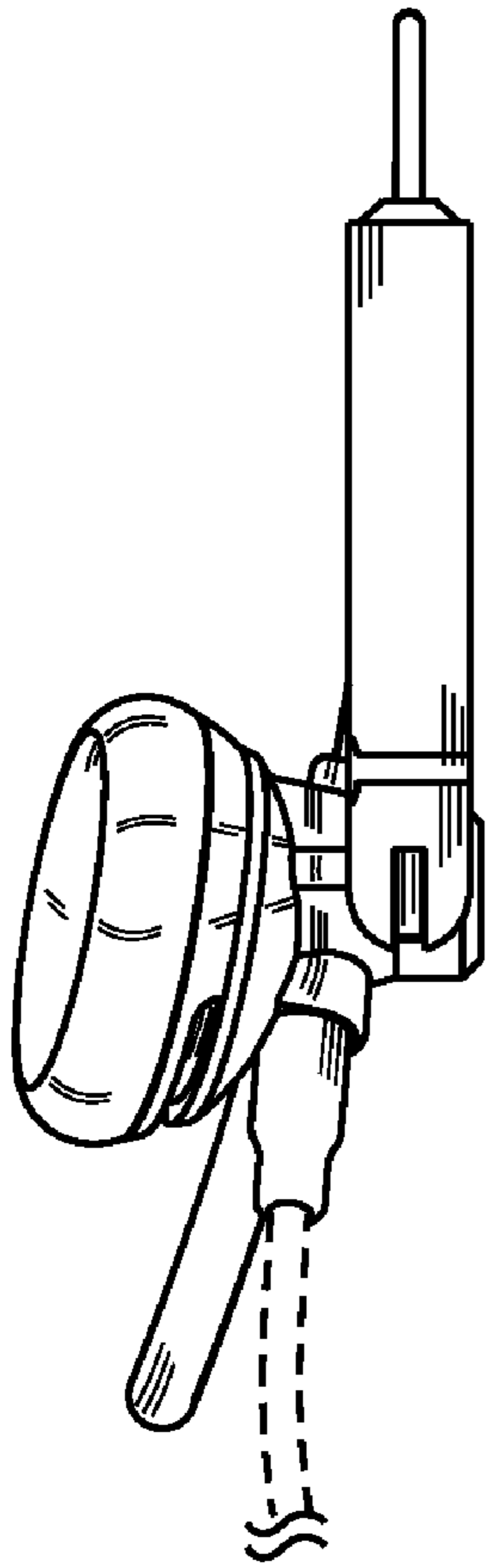

FIG. 4

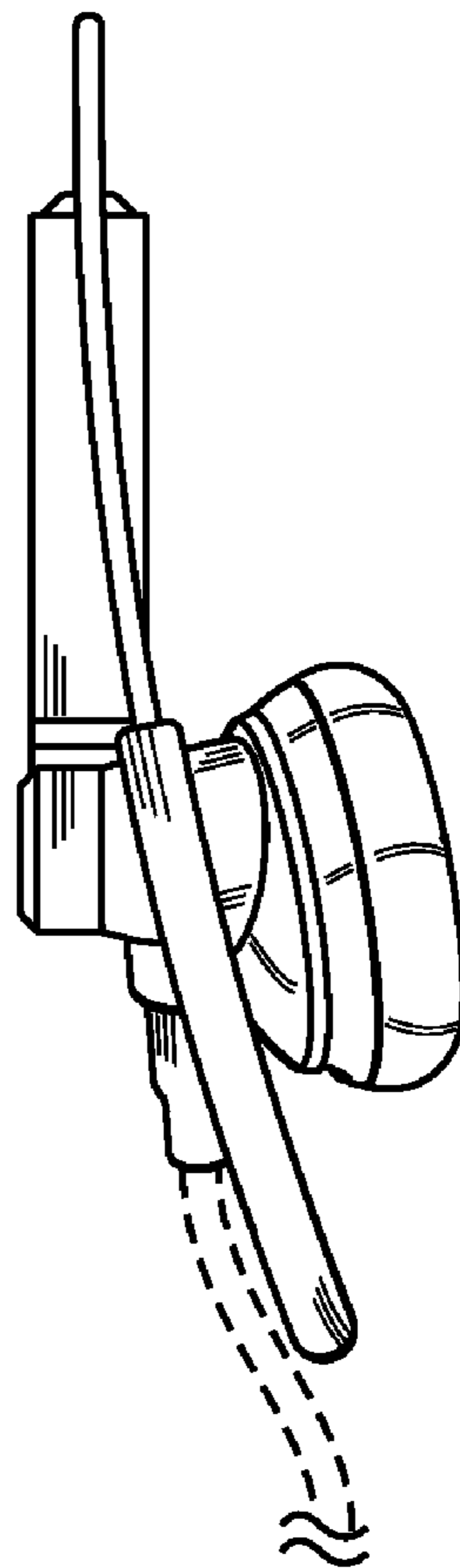

FIG. 5

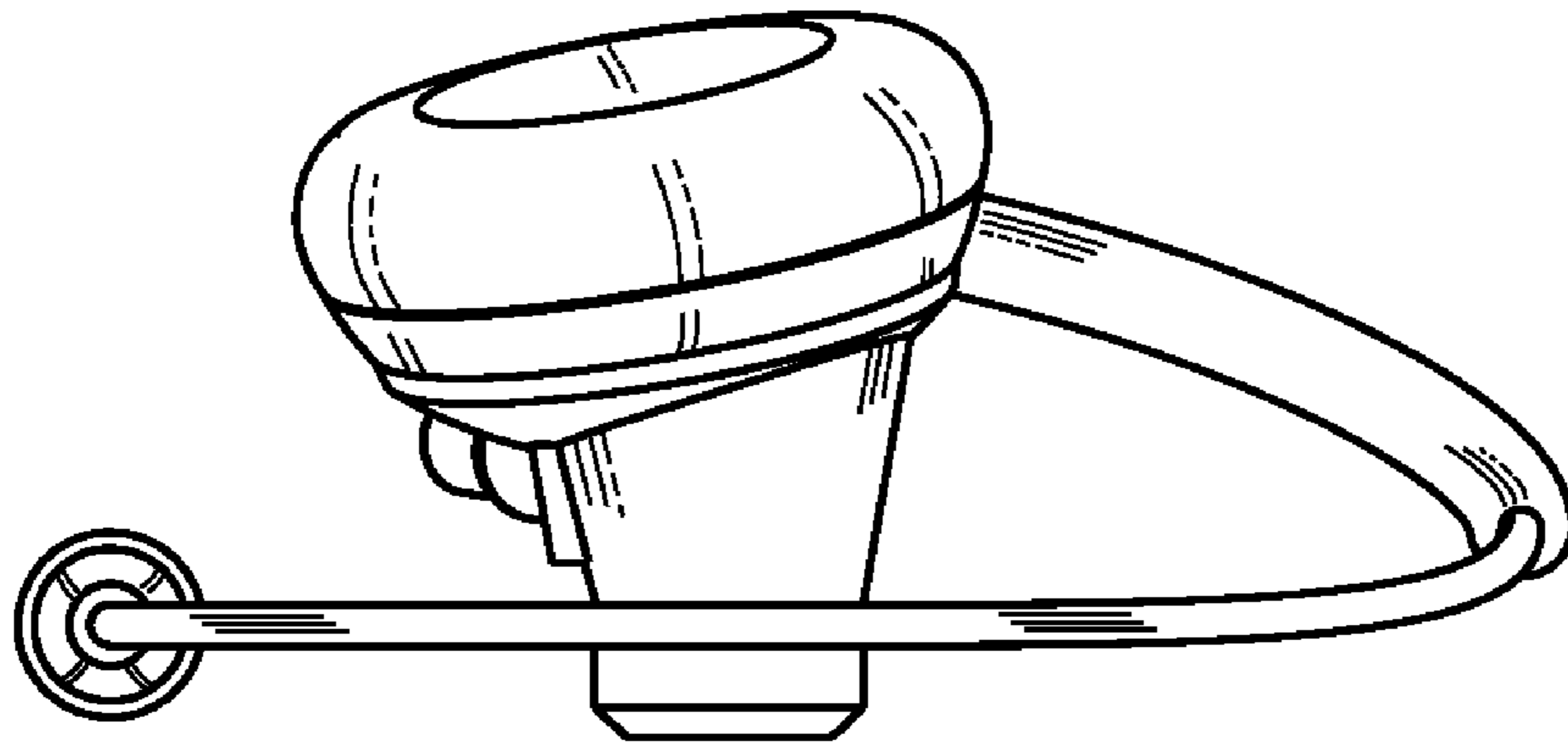

FIG. 6

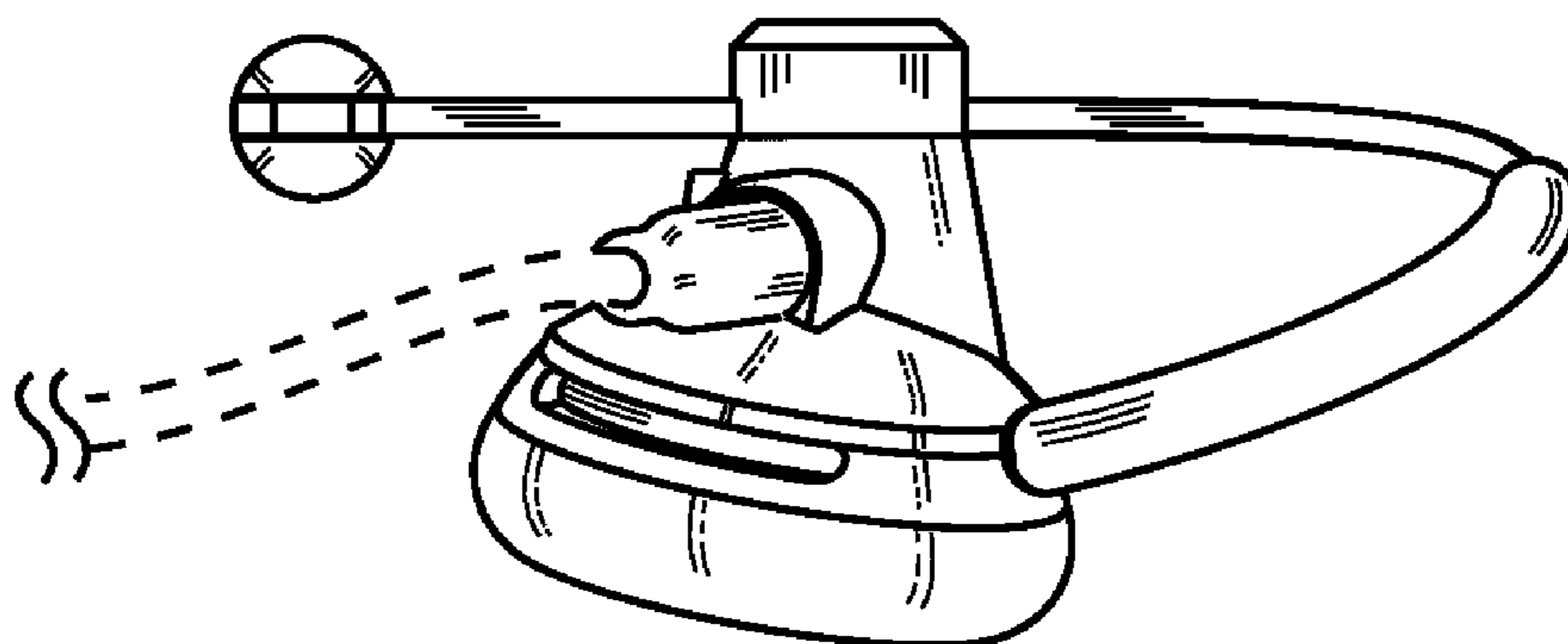

FIG. 7