



US00D606028S

(12) **United States Design Patent**
Chou

(10) **Patent No.:** **US D606,028 S**

(45) **Date of Patent:** **** *Dec. 15, 2009**

(54) **DIMMER SWITCH**

(75) Inventor: **Cheng-Lung Chou**, Great Neck, NY
(US)

(73) Assignee: **Leviton Manufacturing Co., Inc.**, Little
Neck, NY (US)

(**) Term: **14 Years**

(21) Appl. No.: **29/327,358**

(22) Filed: **Nov. 4, 2008**

(51) **LOC (9) Cl.** **13-03**

(52) **U.S. Cl.** **D13/169; D13/171**

(58) **Field of Classification Search** D13/169,
D13/171; 174/66; 200/5 R, 1 B, 433, 525,
200/553, 315, 329, 335, 332, 339; 338/176;
315/291-296

See application file for complete search history.

(56) **References Cited**

U.S. PATENT DOCUMENTS

D121,273 S	7/1940	Davis
2,740,873 A	4/1956	Cronk
D268,564 S	4/1983	Mack
4,489,297 A	12/1984	Haydon et al.
4,567,375 A	1/1986	Jimerson et al.
4,649,323 A	3/1987	Pearlman et al.
4,669,804 A	6/1987	Munroe
4,924,151 A	5/1990	D'Aleo et al.
4,924,349 A	5/1990	Buehler et al.
5,038,081 A	8/1991	Maiale, Jr. et al.
5,059,871 A	10/1991	Pearlman et al.
5,101,141 A	3/1992	Warner et al.
D331,743 S	12/1992	Fujiyoshi
5,191,265 A	3/1993	D'Aleo et al.
D335,283 S	5/1993	Justiniano et al.
D336,894 S	6/1993	Zaretsky et al.
5,225,765 A	7/1993	Callahan et al.
5,248,919 A	9/1993	Hanna et al.

5,319,301 A	6/1994	Callahan et al.
5,338,910 A	8/1994	Tsai
D353,798 S	12/1994	Bryde et al.
5,399,940 A	3/1995	Hanna et al.
D356,999 S	4/1995	Alcocer
5,430,356 A	7/1995	Ference et al.
5,510,679 A	4/1996	Maiale, Jr. et al.
5,530,322 A	6/1996	Ference et al.

(Continued)

OTHER PUBLICATIONS

U.S. Appl. No. 11/559,646 filed Nov. 14, 2006 entitled, "RF Antenna Integrated into a Control Device Installed into a Wall Switch Box".

Primary Examiner—Selina Sikder

(74) *Attorney, Agent, or Firm*—Carter, DeLuca, Farrell & Schmidt, LLP

(57) **CLAIM**

The ornamental design for a dimmer switch, shown and described.

DESCRIPTION

FIG. 1 is a front left perspective view illustrating our new design for a dimmer switch with the broken lines showing, for illustrative purposes only, a back plate and a housing that are not part of the claimed design;

FIG. 2 is a front view thereof with the dashed lines showing the back plate;

FIG. 3 is a left side view thereof with the broken lines showing the back plate and the housing;

FIG. 4 is a right side view thereof with the broken lines showing the back plate and the housing;

FIG. 5 is a top view thereof with the broken lines showing the back plate and the housing; and,

FIG. 6 is a bottom view thereof with the broken lines showing the back plate and the housing.

1 Claim, 4 Drawing Sheets

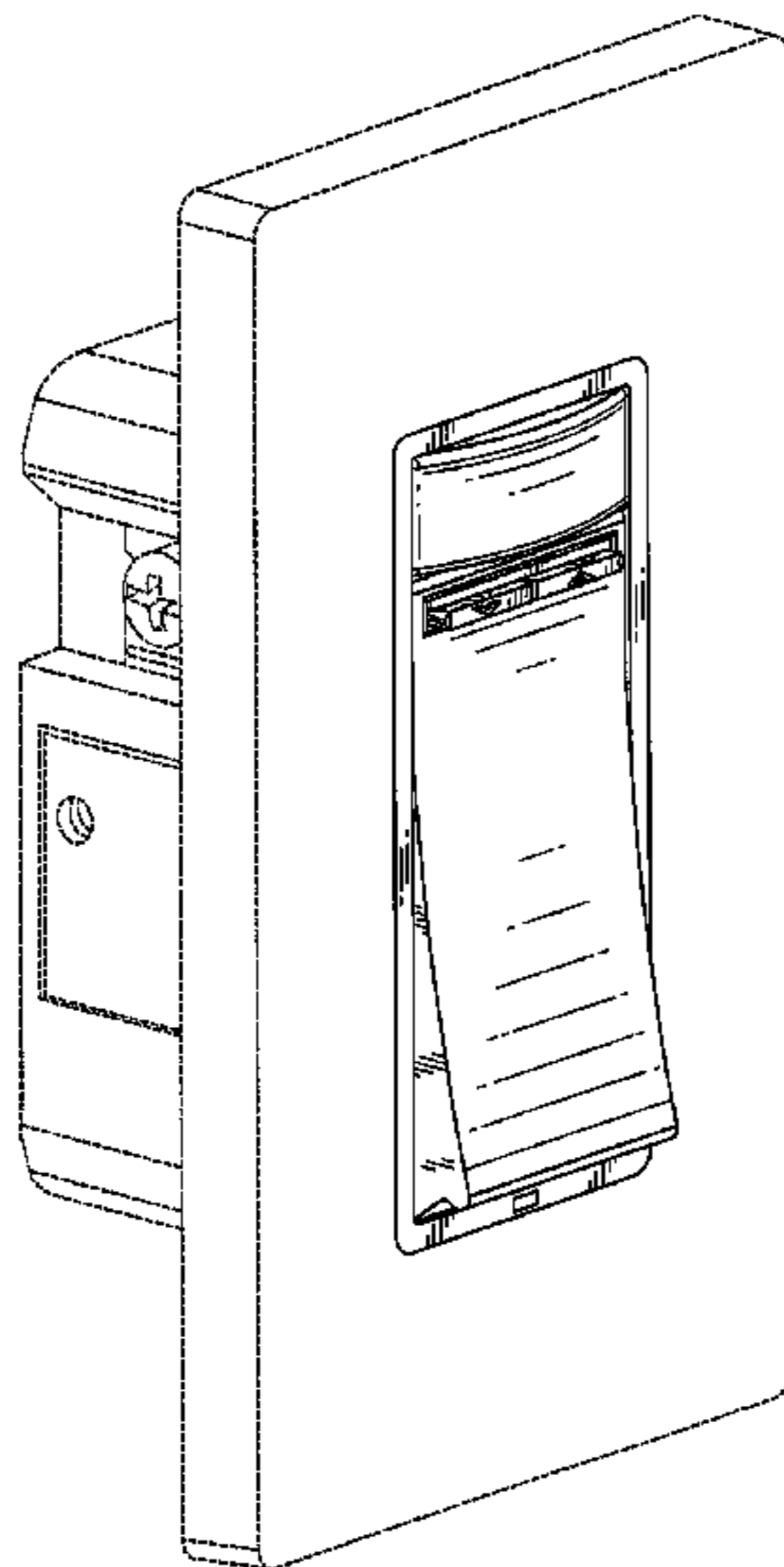

US D606,028 S

Page 2

U.S. PATENT DOCUMENTS

5,637,930 A	6/1997	Rowen et al.	D522,465 S	6/2006	Lombardi et al.
5,662,213 A	9/1997	Kattler et al.	D523,402 S	6/2006	Lombardi et al.
D391,924 S	3/1998	Mayo et al.	D523,824 S	6/2006	Lombardi et al.
5,895,888 A	4/1999	Arenas et al.	7,071,634 B2	7/2006	Johnson et al.
5,909,087 A	6/1999	Bryde et al.	D526,624 S	8/2006	Merritt et al.
5,950,812 A	9/1999	Tanacan et al.	D534,873 S	1/2007	Merritt et al.
6,037,721 A	3/2000	Lansing et al.	D534,875 S	1/2007	Wu
6,046,550 A	4/2000	Ference et al.	D535,627 S	1/2007	Merritt et al.
6,091,205 A	7/2000	Newman, Jr. et al.	7,164,238 B2	1/2007	Kazanov et al.
6,178,681 B1	1/2001	Caloia et al.	7,166,970 B2	1/2007	Johnson et al.
D439,220 S	3/2001	Mayo et al.	7,170,018 B2	1/2007	Ilkhanov
6,211,626 B1	4/2001	Lys et al.	D539,759 S	4/2007	Lombardi et al.
6,297,724 B1	10/2001	Bryans et al.	D542,230 S	5/2007	Merritt et al.
6,340,868 B1	1/2002	Lys et al.	D543,159 S	5/2007	Merritt et al.
6,347,028 B1	2/2002	Hausman, Jr. et al.	7,247,793 B2 *	7/2007	Hinkson et al. 174/66
6,369,524 B1	4/2002	Sid	D553,102 S	10/2007	Merritt
6,380,692 B1	4/2002	Newman, Jr. et al.	D563,326 S	3/2008	Patel et al.
6,421,941 B1 *	7/2002	Finke et al. 40/611.05	D563,904 S	3/2008	Patel et al.
6,459,919 B1	10/2002	Lys et al.	D576,565 S	9/2008	Chou et al.
6,469,457 B2	10/2002	Callahan	D576,566 S	9/2008	Wu et al.
6,507,158 B1	1/2003	Wang	D588,035 S	3/2009	Schmalz et al.
6,528,957 B1	3/2003	Luchaco	2003/0076281 A1	4/2003	Morgan et al.
6,545,434 B2	4/2003	Sembhi et al.	2003/0226682 A1	12/2003	Tufano et al.
6,761,470 B2	7/2004	Sid	2003/0226684 A1	12/2003	Schmieta et al.
D498,213 S	11/2004	Savicki, Jr. et al.	2004/0002792 A1	1/2004	Hoffknecht
6,891,117 B1	5/2005	Gouhl et al.	2004/0212324 A1	10/2004	Callahan
6,917,167 B2	7/2005	Courtney et al.	2005/0125083 A1	6/2005	Kiko
D513,607 S	1/2006	Lombardi et al.	2005/0248300 A1	11/2005	Walko et al.
D517,999 S	3/2006	Merritt et al.	2006/0125649 A1	6/2006	Ostrovsky et al.
D518,000 S	3/2006	Merritt et al.	2006/0279236 A1	12/2006	Johnson et al.
D519,466 S	4/2006	Merritt et al.	2007/0126366 A1	6/2007	Frid
D521,944 S	5/2006	Lombardi et al.	2007/0193863 A1	8/2007	Wu
7,038,910 B1	5/2006	Hodge et al.	2008/0237010 A1	10/2008	Patel et al.

* cited by examiner

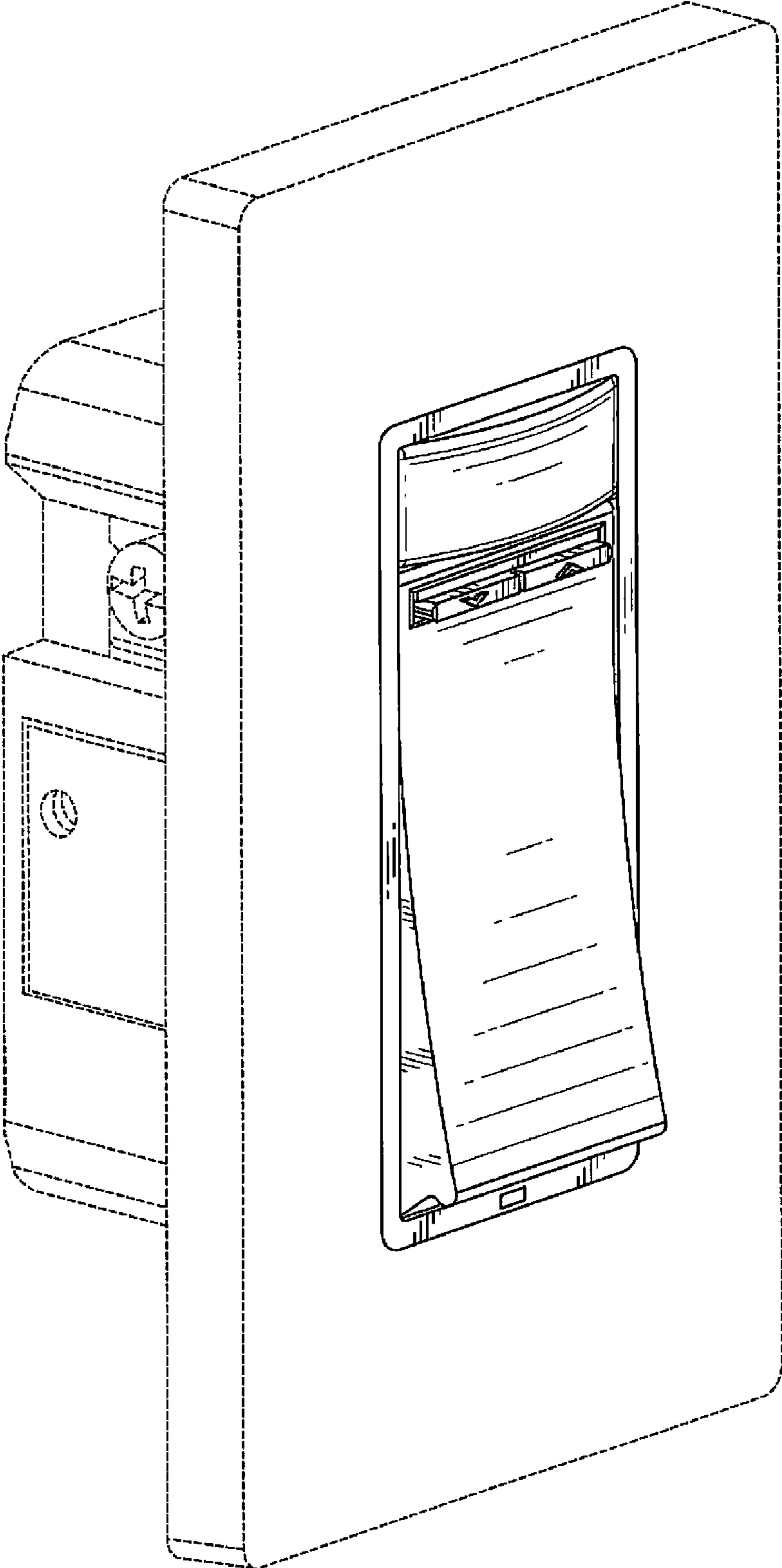

FIG. 1

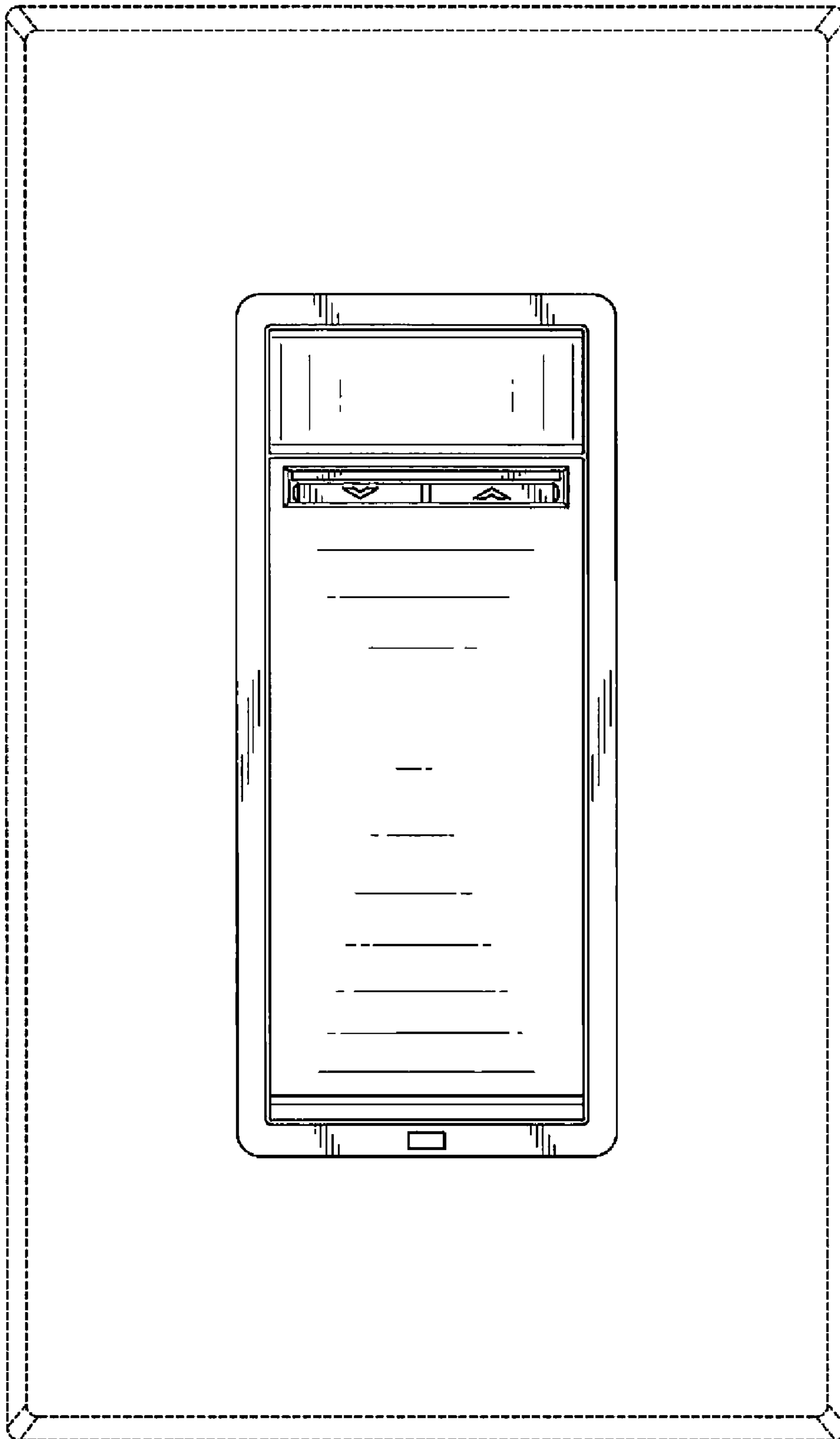

FIG. 2

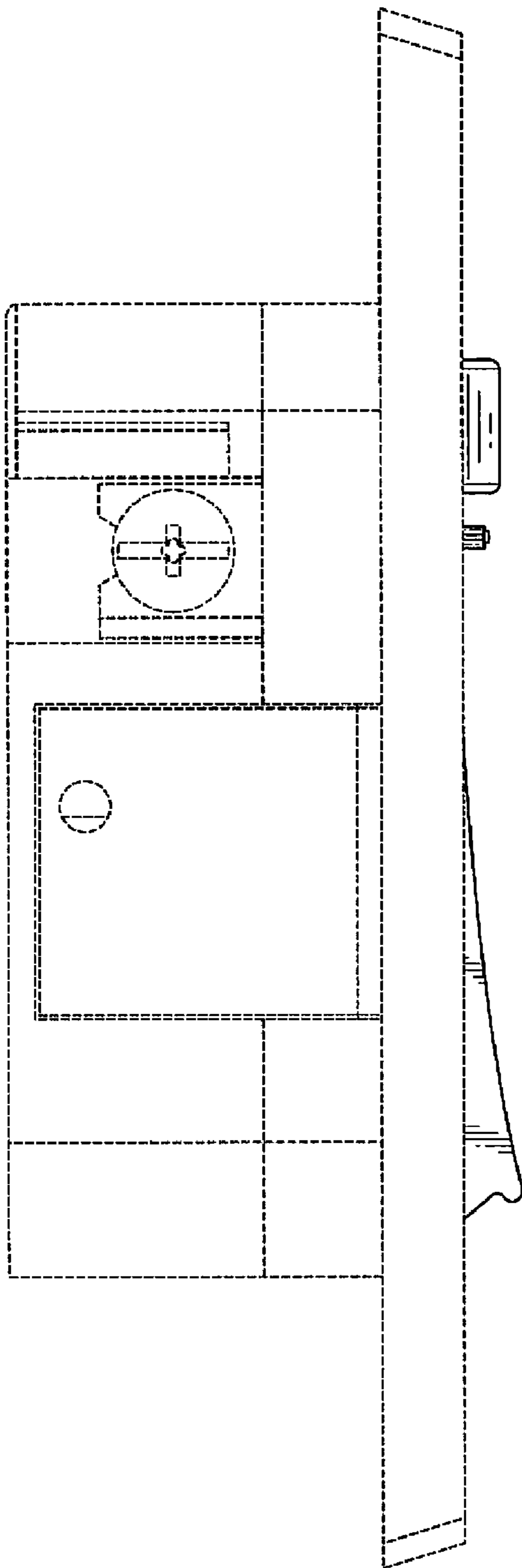

FIG. 3

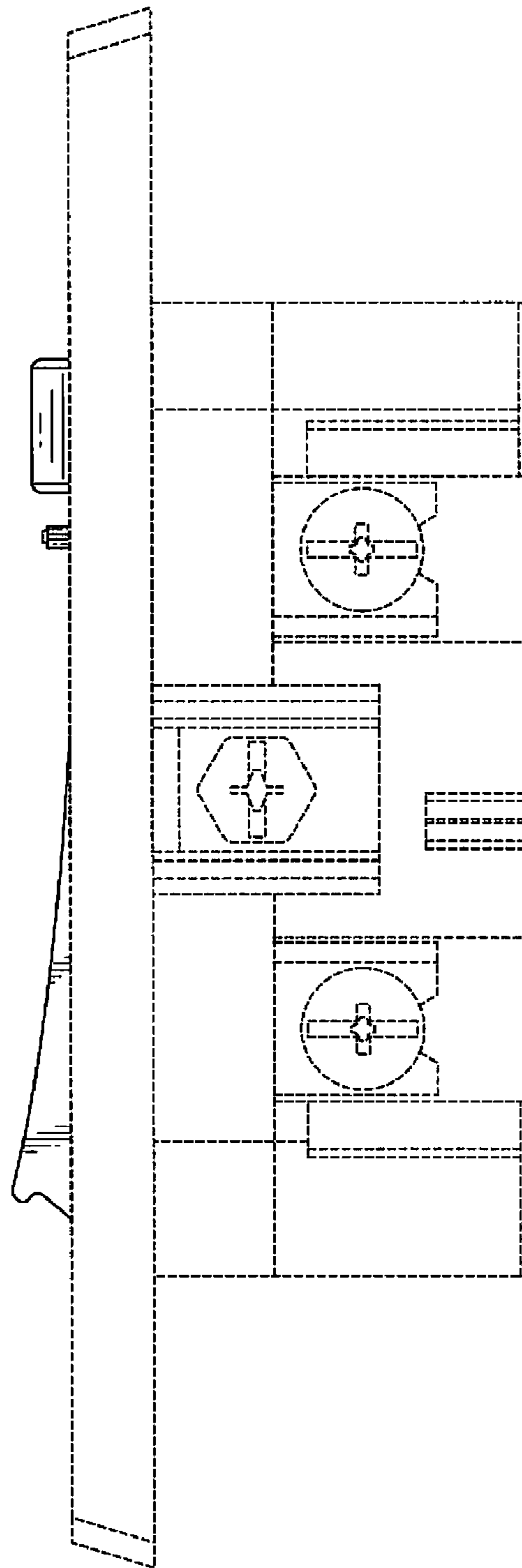

FIG. 4

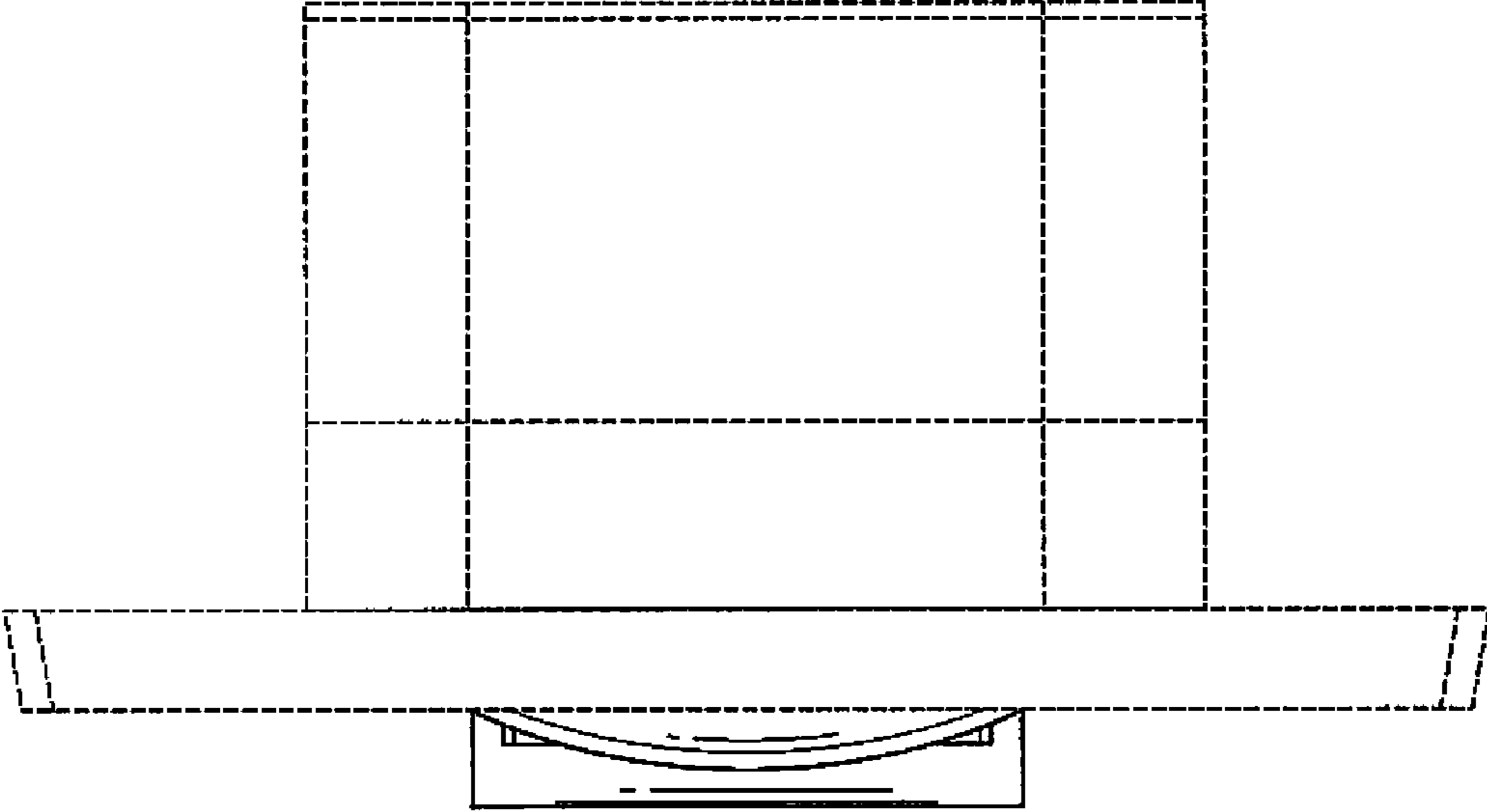

FIG. 5

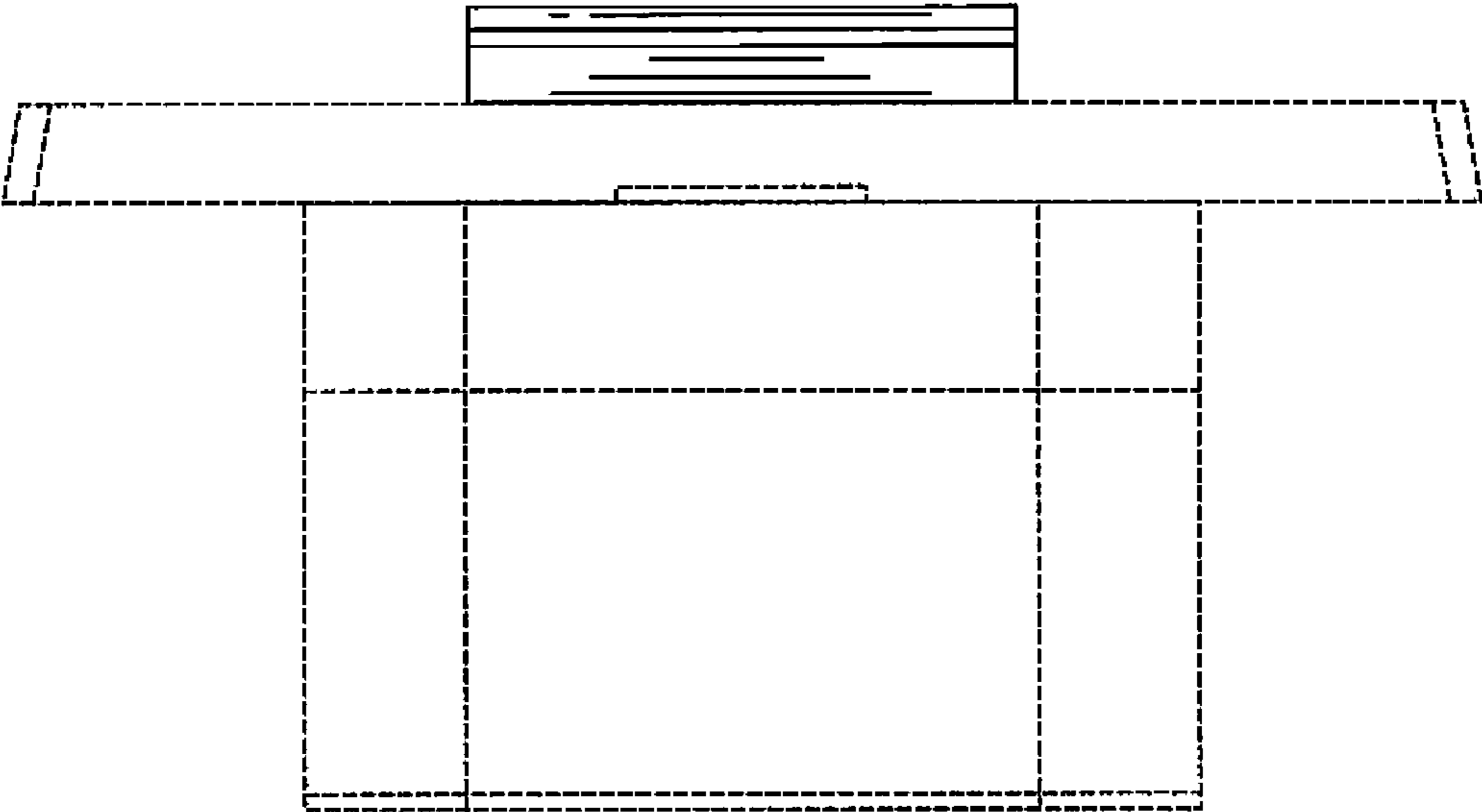

FIG. 6