



US00D605996S

(12) **United States Design Patent**
Kruger et al.

(10) **Patent No.:** **US D605,996 S**

(45) **Date of Patent:** **** Dec. 15, 2009**

(54) **VEHICLE MIRROR**

(75) Inventors: **Scott Kruger**, Macomb, MI (US);
Mark T. Allen, Oxford, MI (US); **Ralph V. Gilles**, Leonard, MI (US); **Timothy W. Anness**, Rochester Hills, MI (US)

(73) Assignee: **Chrysler Group LLC**, Auburn Hills, MI (US)

(**) Term: **14 Years**

(21) Appl. No.: **29/333,809**

(22) Filed: **Mar. 16, 2009**

Related U.S. Application Data

(63) Continuation-in-part of application No. 29/304,483, filed on Mar. 3, 2008, now Pat. No. Des. 588,501.

(51) **LOC (9) Cl.** **12-16**

(52) **U.S. Cl.** **D12/187**

(58) **Field of Classification Search** D12/187,
D12/188-189, 96; D6/300, 309; 359/838,
359/841, 843, 844, 868, 871, 604, 881, 514,
359/866; 248/479-483, 475.1

See application file for complete search history.

(56) **References Cited**

U.S. PATENT DOCUMENTS

D577,320 S * 9/2008 Choi et al. D12/187

D579,839 S * 11/2008 Gale et al. D12/187
D586,276 S * 2/2009 Pfeiffer D12/187
7,490,946 B1 * 2/2009 Foote et al. 359/841
2005/0254133 A1 * 11/2005 Akram et al. 359/626

* cited by examiner

Primary Examiner—Caron Veynar

Assistant Examiner—Katrina A Kile

(74) *Attorney, Agent, or Firm*—Ralph E. Smith

(57) **CLAIM**

The ornamental design for a vehicle mirror, as shown and described.

DESCRIPTION

FIG. 1 is a front perspective view of a vehicle mirror showing our new design;

FIG. 2 is a front view thereof;

FIG. 3 is a top view thereof;

FIG. 4 is a bottom view thereof;

FIG. 5 is a left side view thereof;

FIG. 6 is a rear view thereof; and,

FIG. 7 is a right view thereof.

The broken lines in the drawings show internal structures and form no part of the claimed design.

1 Claim, 7 Drawing Sheets

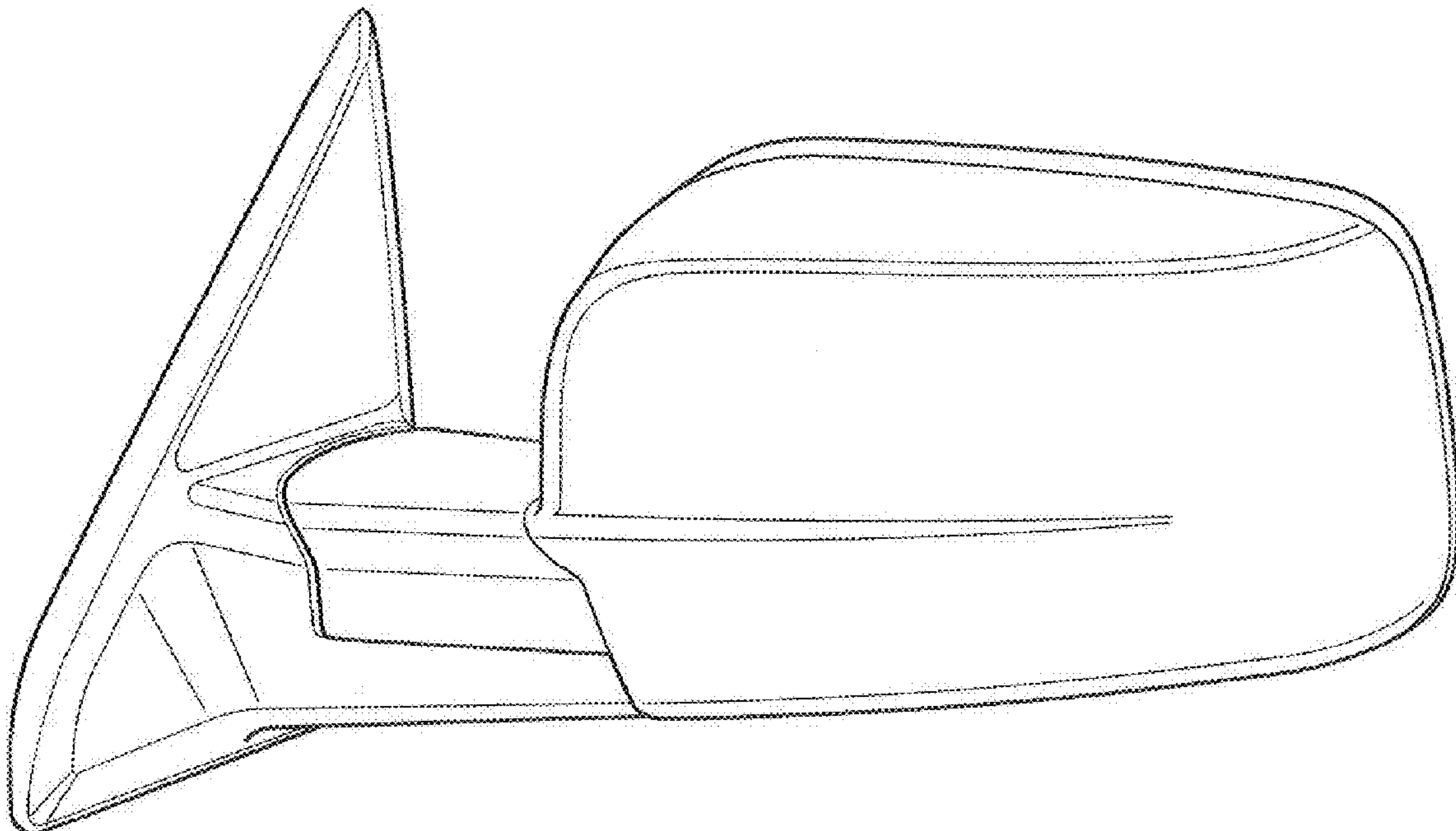

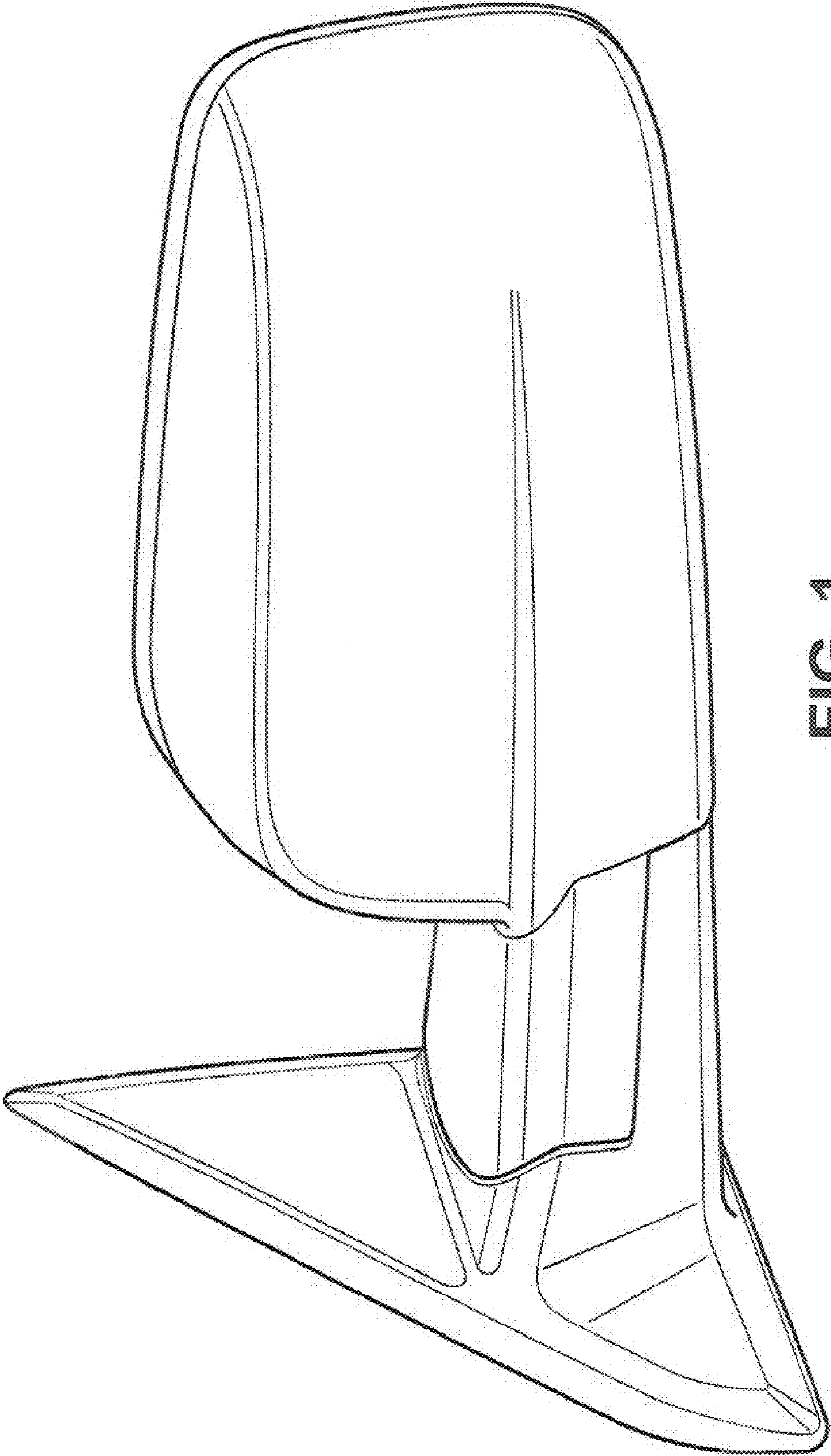

FIG. 1

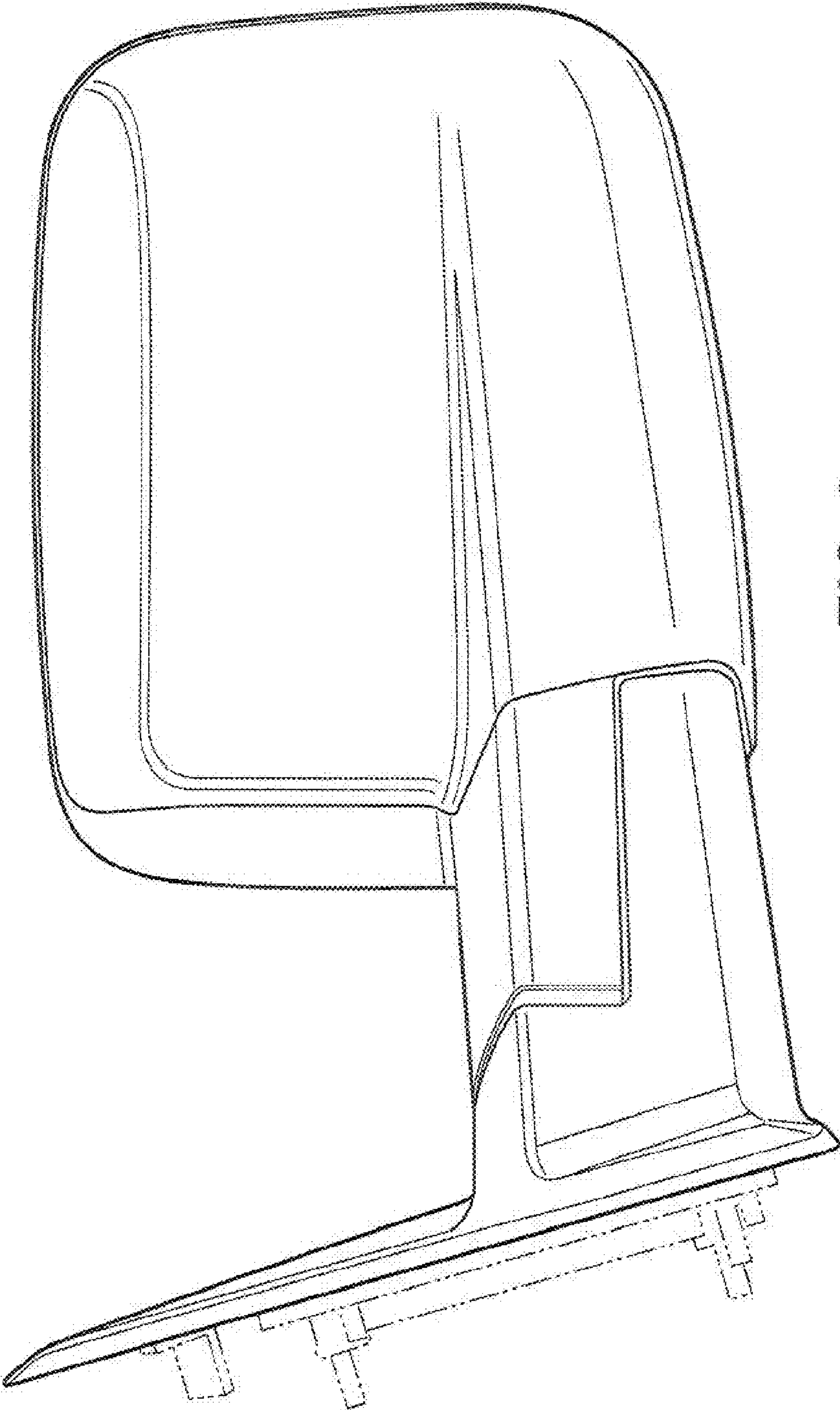

FIG. 2

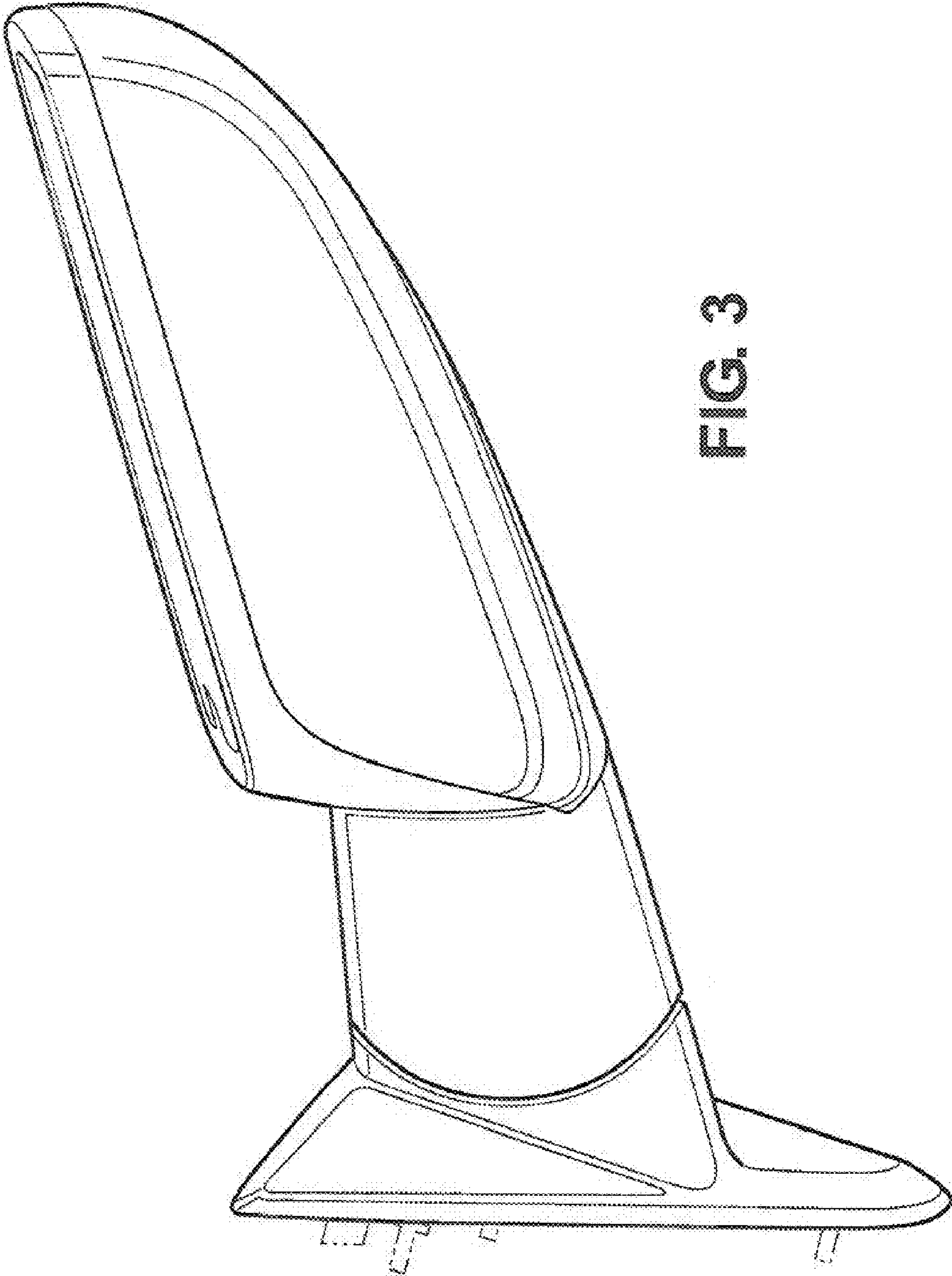
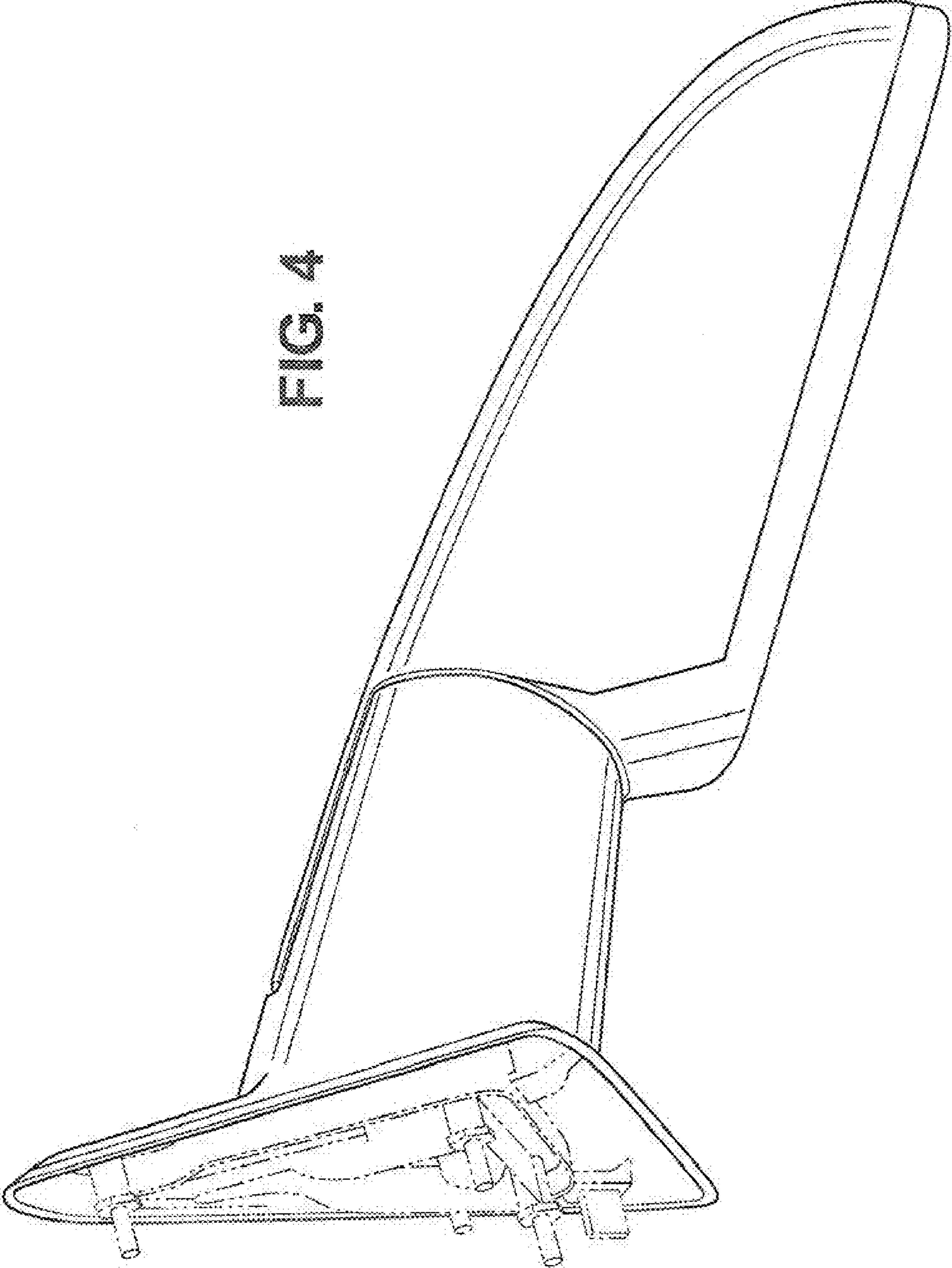

FIG. 3

FIG. 4



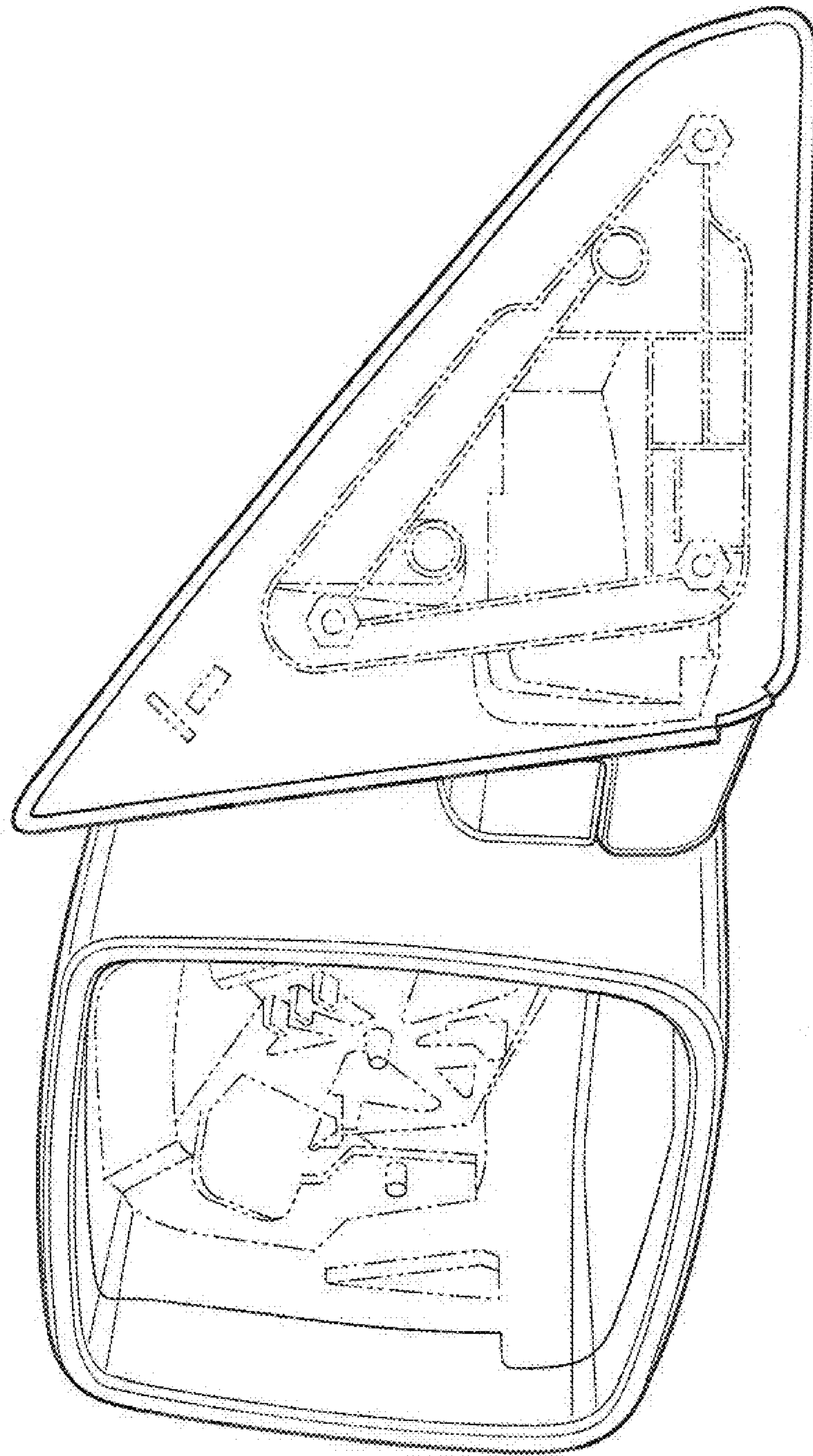

FIG. 5

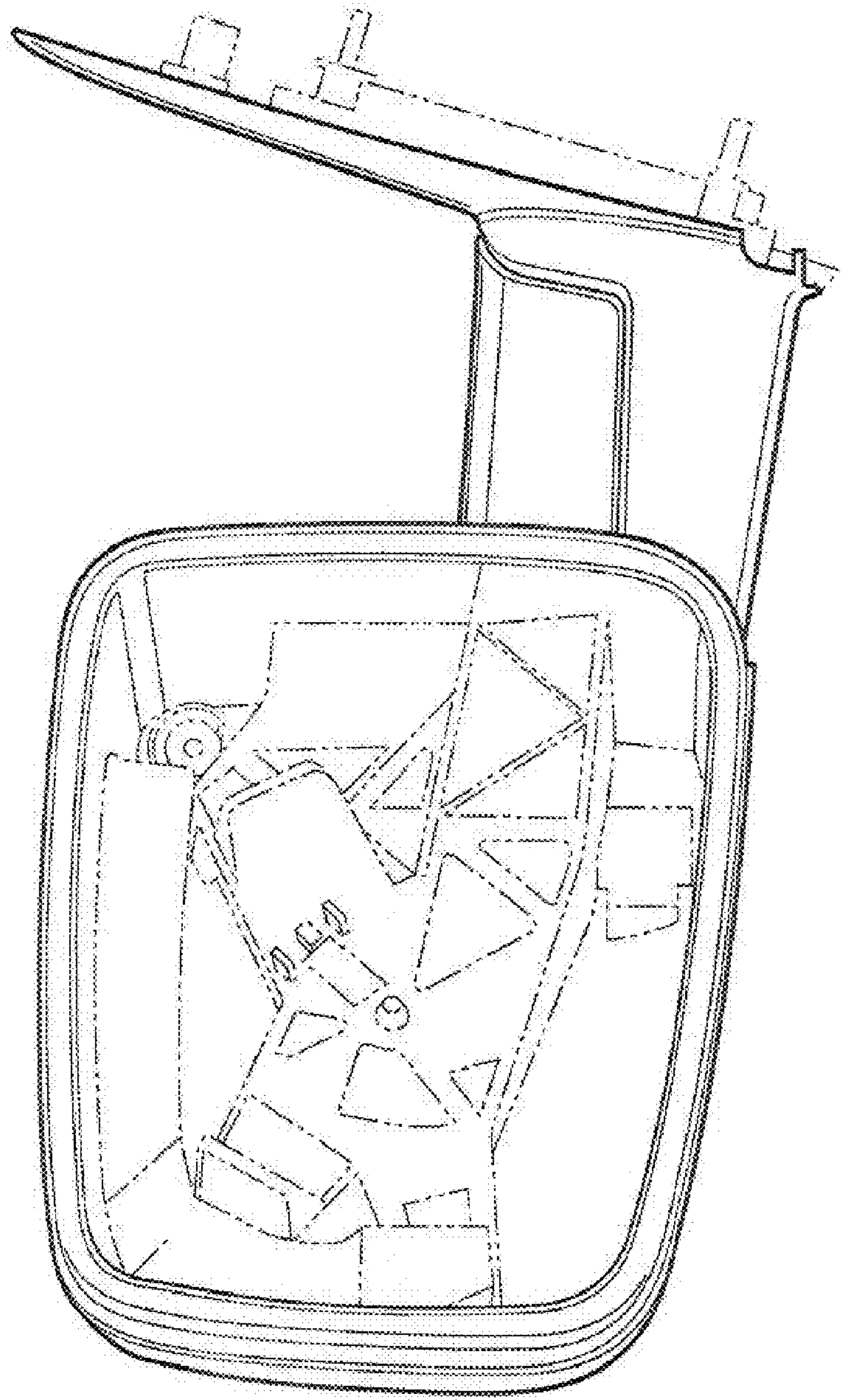

FIG. 6

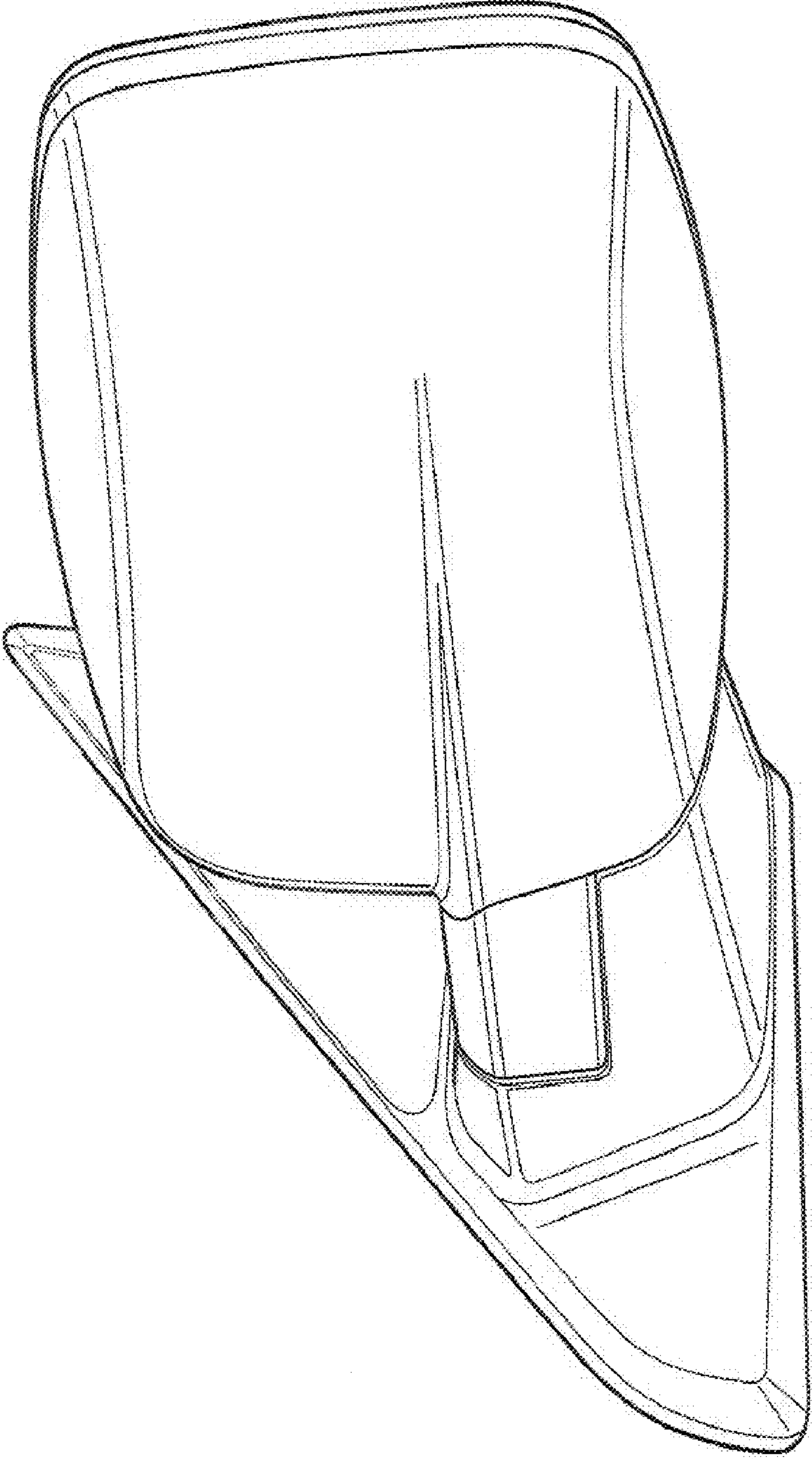

FIG. 7