



US00D605870S

(12) **United States Design Patent**  
**Bergkvist et al.**

(10) **Patent No.:** **US D605,870 S**

(45) **Date of Patent:** **\*\* Dec. 15, 2009**

(54) **BABY COT**

(75) Inventors: **Hakan Bergkvist**, Stockholm (SE);  
**Lisen Elmberg**, Stockholm (SE)

(73) Assignee: **Baby Bjorn AB**, Danderyd (SE)

(\*\*) Term: **14 Years**

(21) Appl. No.: **29/311,326**

(22) Filed: **Feb. 20, 2009**

(30) **Foreign Application Priority Data**

Nov. 19, 2008 (EM) ..... 001042154

(51) **LOC (9) Cl.** ..... **06-03**

(52) **U.S. Cl.** ..... **D6/390**

(58) **Field of Classification Search** ..... D6/390,  
D6/391, 331, 333; 5/93.1, 97, 98.1, 99.1,  
5/93.2

See application file for complete search history.

(56) **References Cited**

**U.S. PATENT DOCUMENTS**

822,889 A \* 6/1906 Faget ..... 5/104

D47,415 S \* 6/1915 Barker ..... D6/390  
D137,982 S \* 5/1944 Lanese ..... D6/390  
D320,316 S \* 10/1991 Arnold ..... D6/390  
D526,133 S \* 8/2006 Song ..... D6/331

\* cited by examiner

*Primary Examiner*—Janice E Seeger

(74) *Attorney, Agent, or Firm*—Jacobson Holman PLLC

(57) **CLAIM**

The ornamental design for a baby cot, as shown and described.

**DESCRIPTION**

FIG. 1 is a perspective view showing our new design for a baby cot,

FIG. 2 is a front view thereof,

FIG. 3 is a left side thereof,

FIG. 4 is a right side thereof,

FIG. 5 is a top plan view thereof,

FIG. 6 is a bottom view thereof; and,

FIG. 7 is a perspective view of the underside thereof.

**1 Claim, 7 Drawing Sheets**

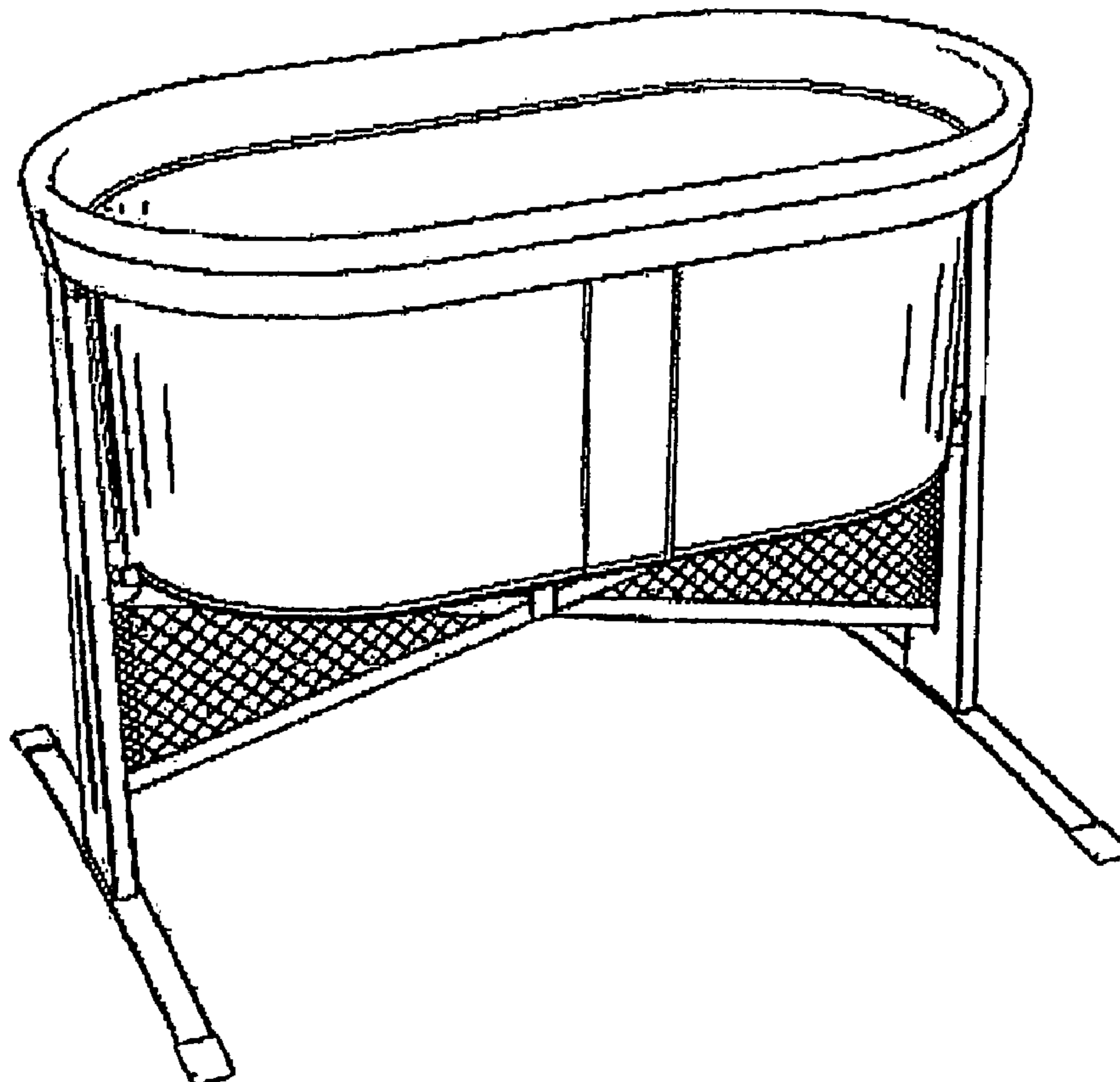

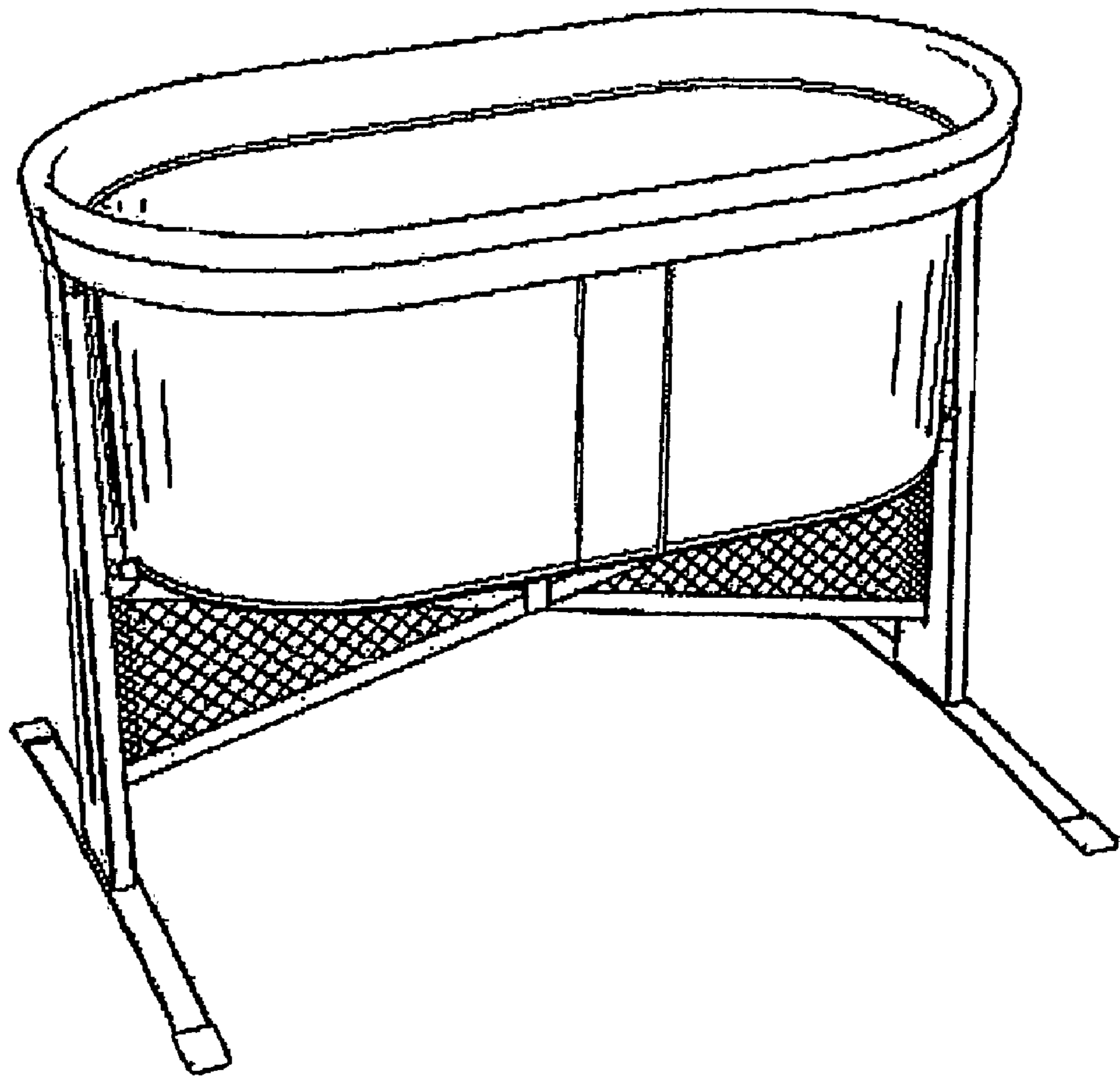

FIG. 1

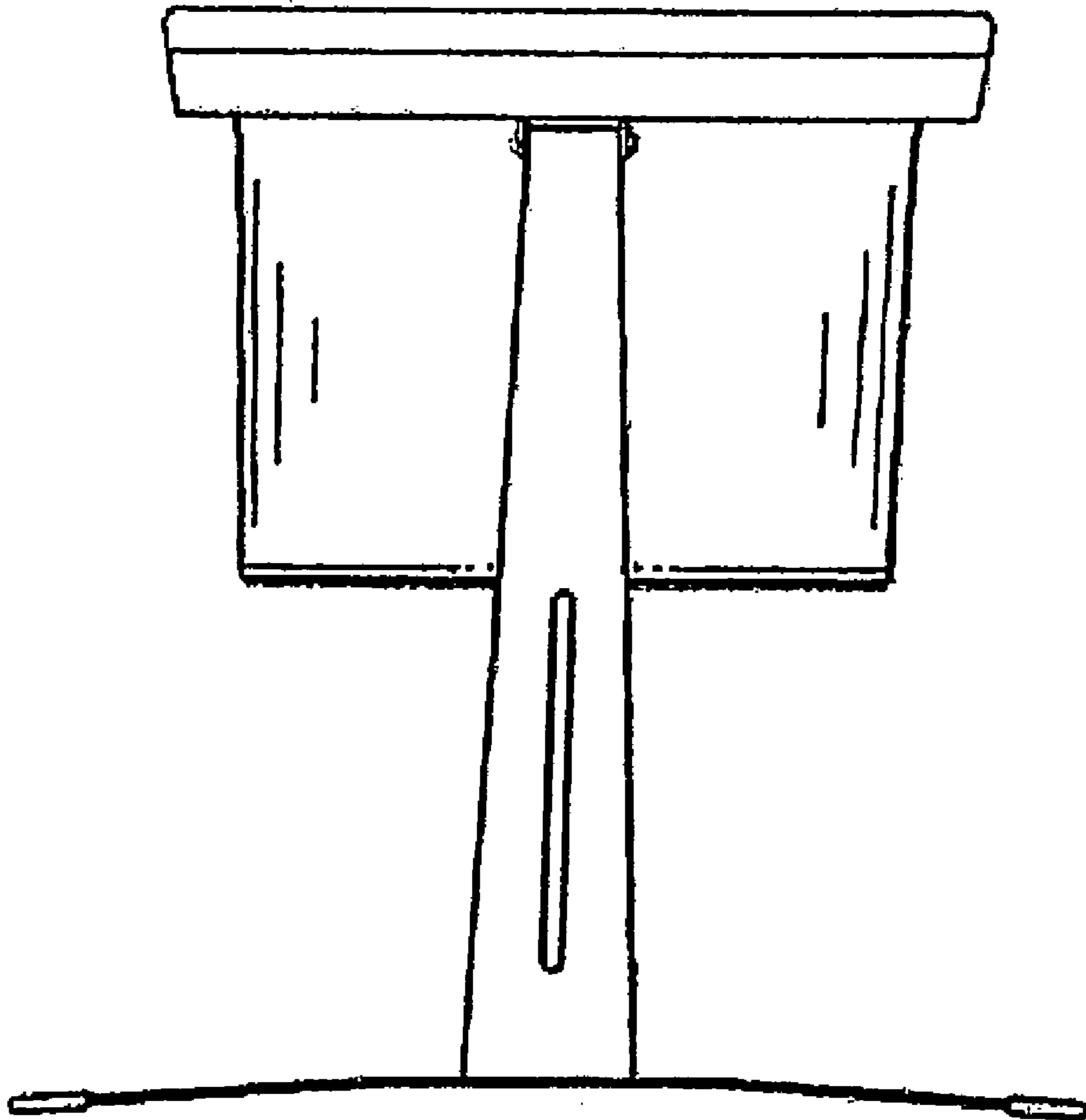

FIG. 2

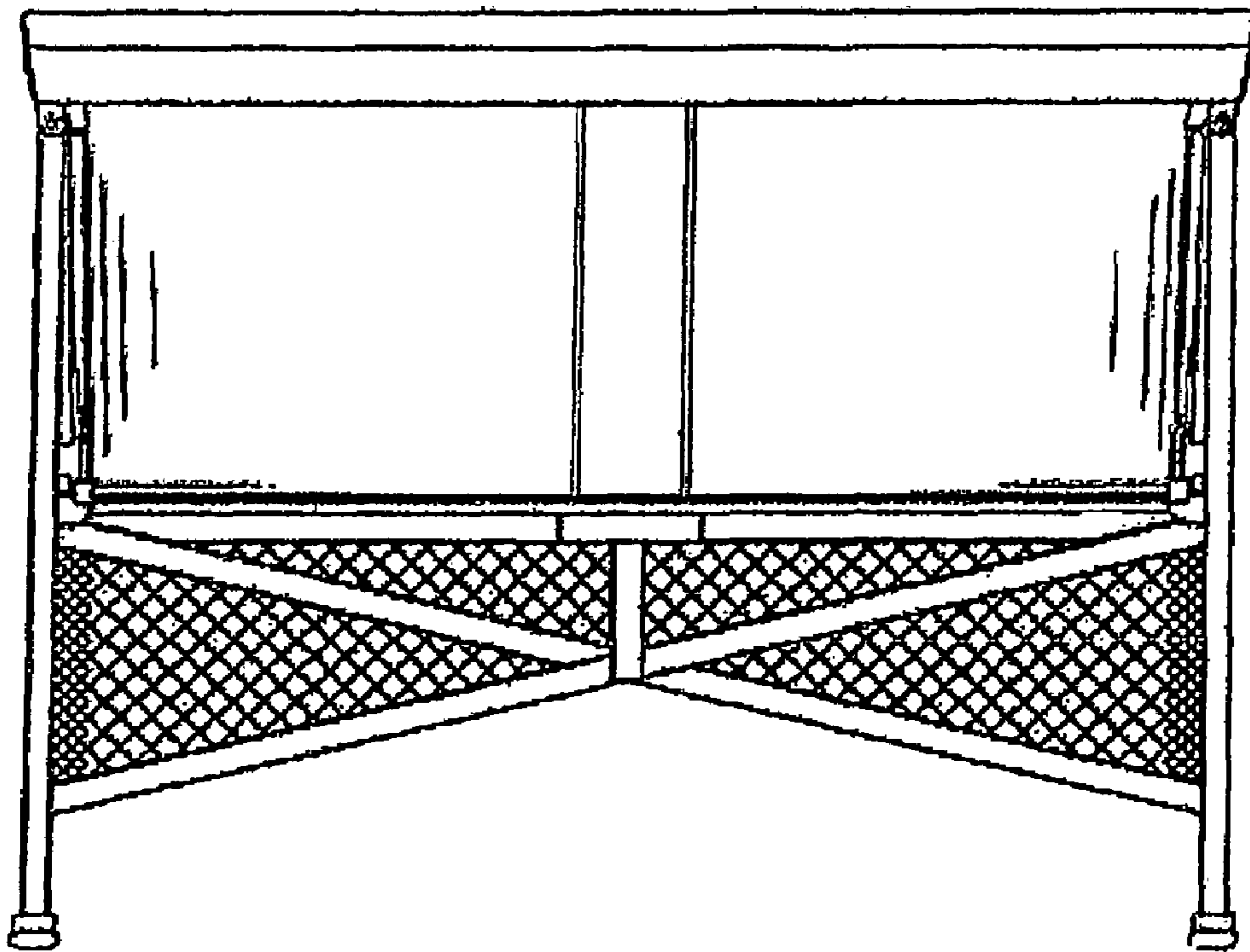

FIG. 3

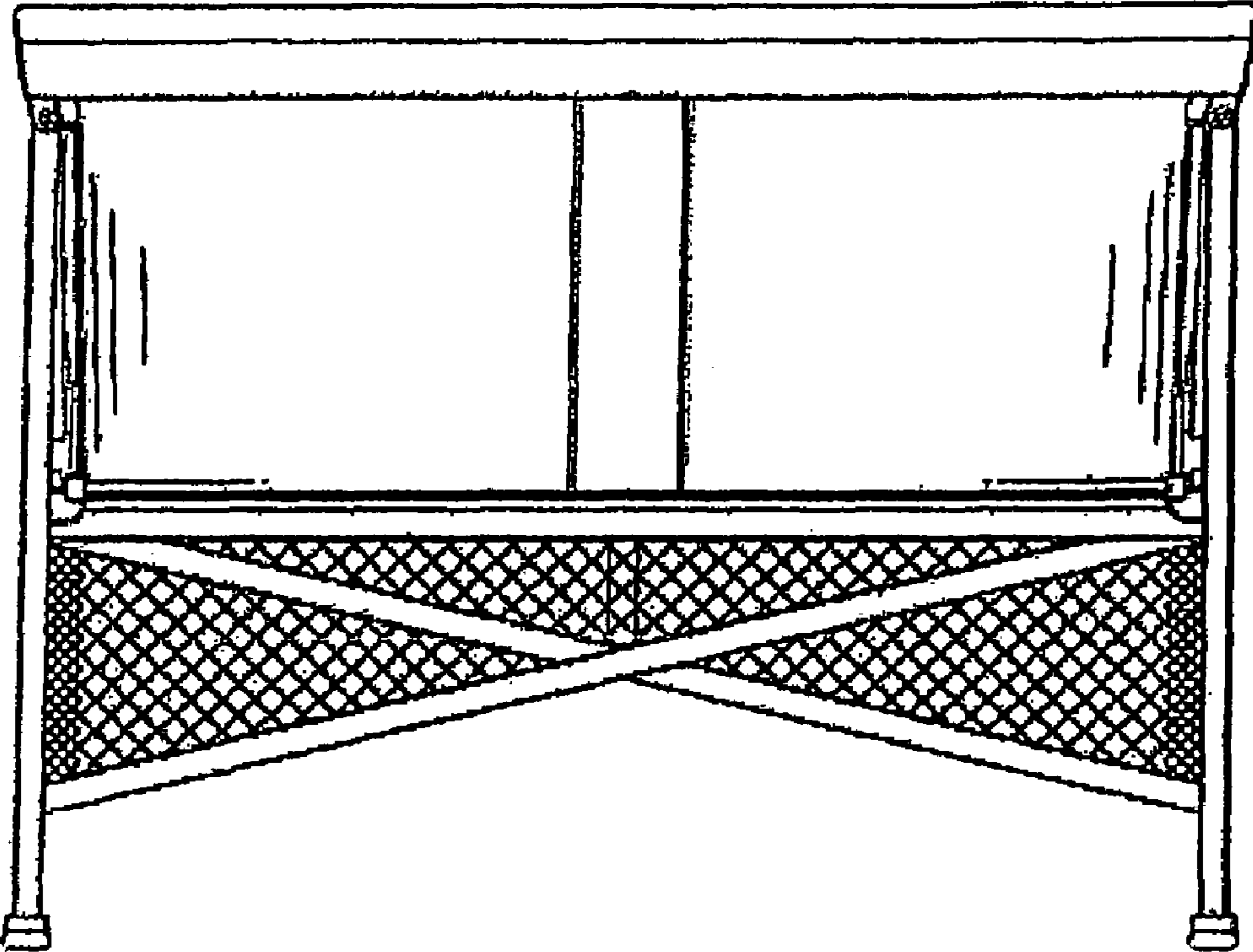

FIG. 4

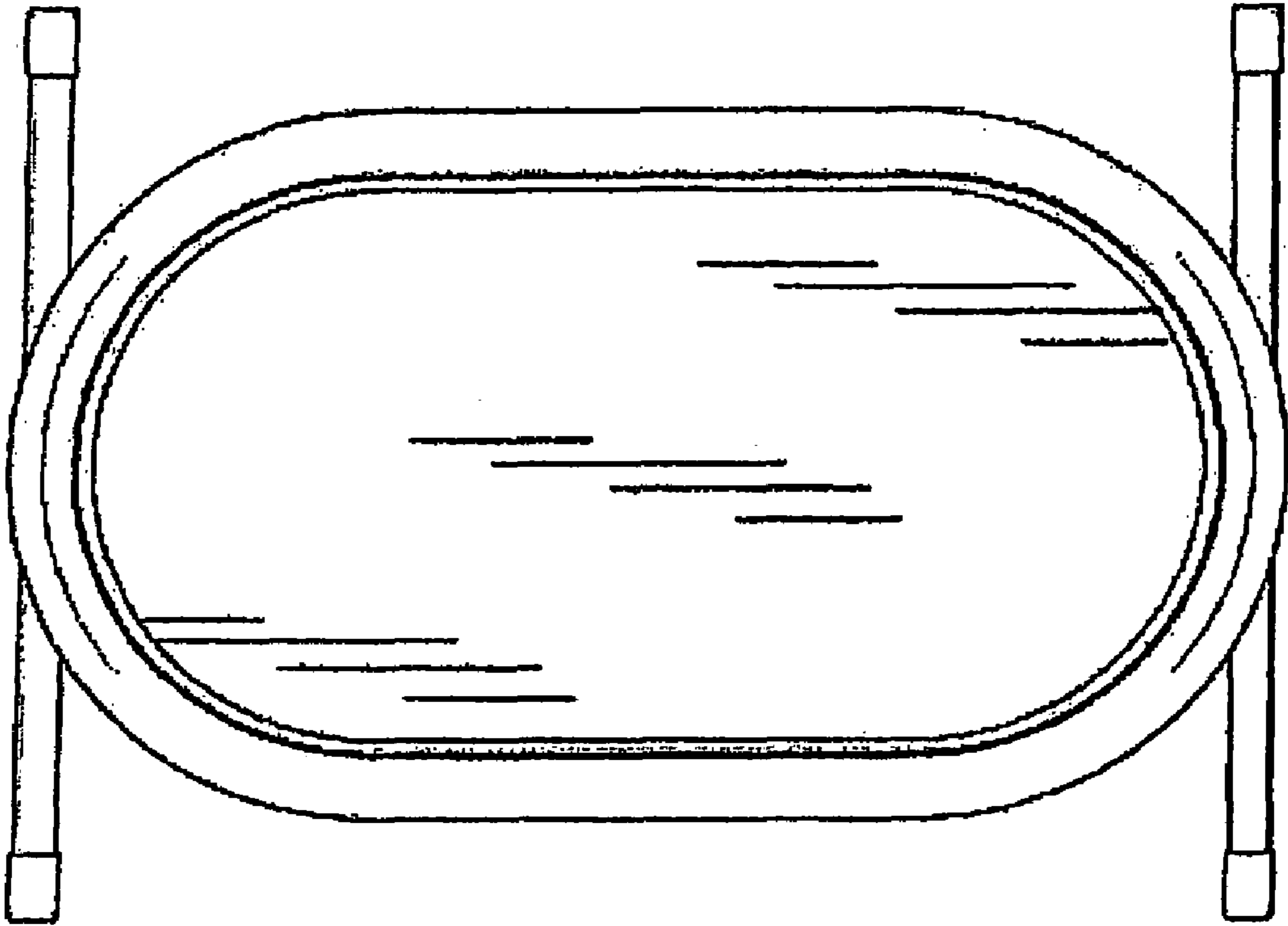

FIG. 5

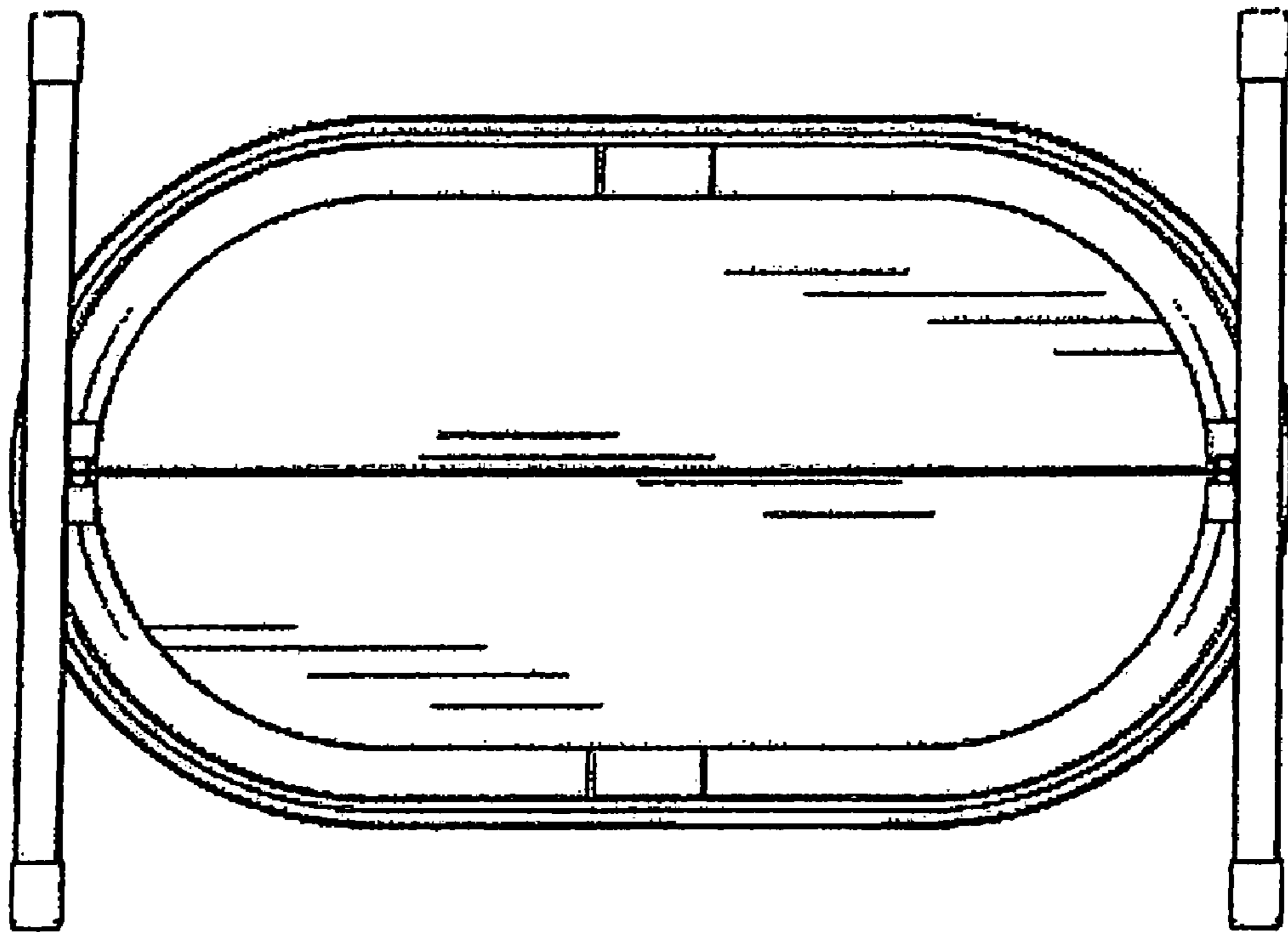

FIG. 6



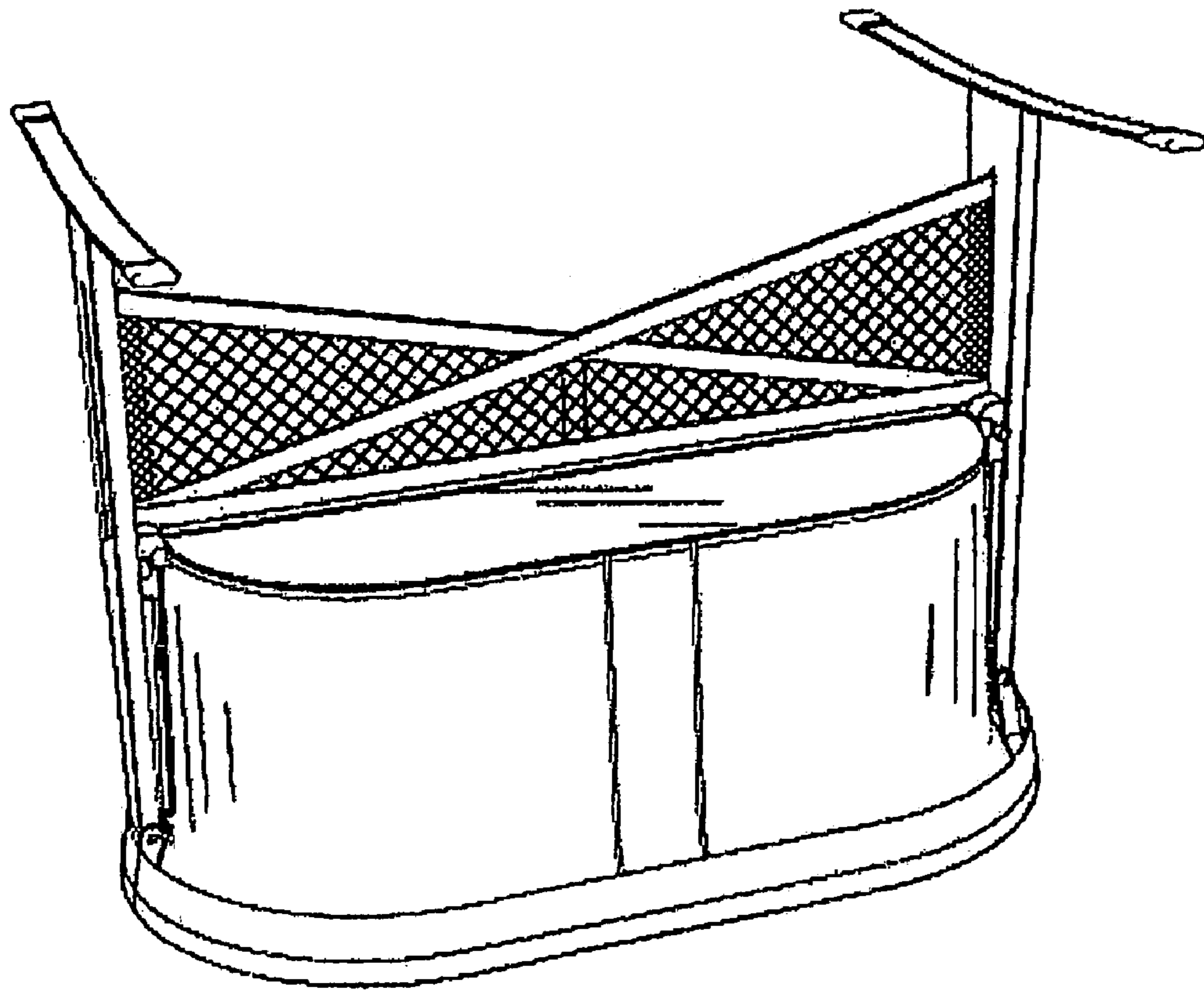

FIG. 7