



US00D605863S

(12) **United States Design Patent**
Aruga et al.

(10) **Patent No.:** **US D605,863 S**
(45) **Date of Patent:** **** Dec. 15, 2009**

(54) **AIRCRAFT SEAT**

(75) Inventors: **Hiroyasu Aruga**, Nagoya (JP);
Motohiko Kawaguchi, Nagoya (JP);
Etsunori Fujita, Hiroshima-ken (JP)
(73) Assignees: **Mitsubishi Heavy Industries, Ltd.** (JP);
Mitsubishi Aircraft Corporation (JP);
Delta Kogyo Co., Ltd. (JP)

(**) Term: **14 Years**
(21) Appl. No.: **29/330,547**
(22) Filed: **Jan. 9, 2009**

(30) **Foreign Application Priority Data**
Jul. 10, 2008 (JP) 2008-017745

(51) **LOC (9) Cl.** **06-01**
(52) **U.S. Cl.** **D6/356**
(58) **Field of Classification Search** D6/334-336,
D6/356, 367, 368, 371-373, 374, 375, 376,
D6/379, 381, 500-502; 297/116, 117, 146,
297/163, 173, 216.1, 216.2, 232, 233, 248,
297/331, 335, 344.1, 353, 354.1, 411.31,
297/452.18; 244/122 R

See application file for complete search history.

(56) **References Cited**

U.S. PATENT DOCUMENTS

3,795,422 A * 3/1974 Robinson et al. 297/146
D250,071 S * 10/1978 Dickerson D6/356
D267,372 S * 12/1982 Long et al. D6/356
4,440,441 A * 4/1984 Marrujo et al. 297/216.2
D281,471 S * 11/1985 Sauter D6/356

D336,379 S * 6/1993 Veneruso D6/356
5,224,755 A * 7/1993 Beroth 297/216.1
5,558,401 A * 9/1996 Singla Casasayas 297/232
5,800,013 A * 9/1998 Branham et al. 297/232
6,644,738 B2 * 11/2003 Williamson 297/232
6,776,457 B2 * 8/2004 Muin et al. 297/331
6,793,282 B2 * 9/2004 Plant et al. 297/248
D505,796 S * 6/2005 Johnson D6/356
2003/0094542 A1 * 5/2003 Williamson 244/122 R
2006/0232117 A1 * 10/2006 Johnson 297/452.18

* cited by examiner

Primary Examiner—Mimosa De
(74) *Attorney, Agent, or Firm*—Birch, Stewart, Kolasch &
Birch, LLP

(57) **CLAIM**

The ornamental design for an aircraft seat, as shown and described.

DESCRIPTION

FIG. 1 is a perspective view from the front side of an aircraft seat.
FIG. 2 is a perspective view from the rear side thereof.
FIG. 3 is a front elevation view thereof.
FIG. 4 is a rear elevation view thereof.
FIG. 5 is a top plan view thereof.
FIG. 6 is a bottom plan view thereof.
FIG. 7 is a left side elevation view thereof.
FIG. 8 is a right side elevation view thereof; and,
FIG. 9 is a referential view showing use thereof.

1 Claim, 9 Drawing Sheets

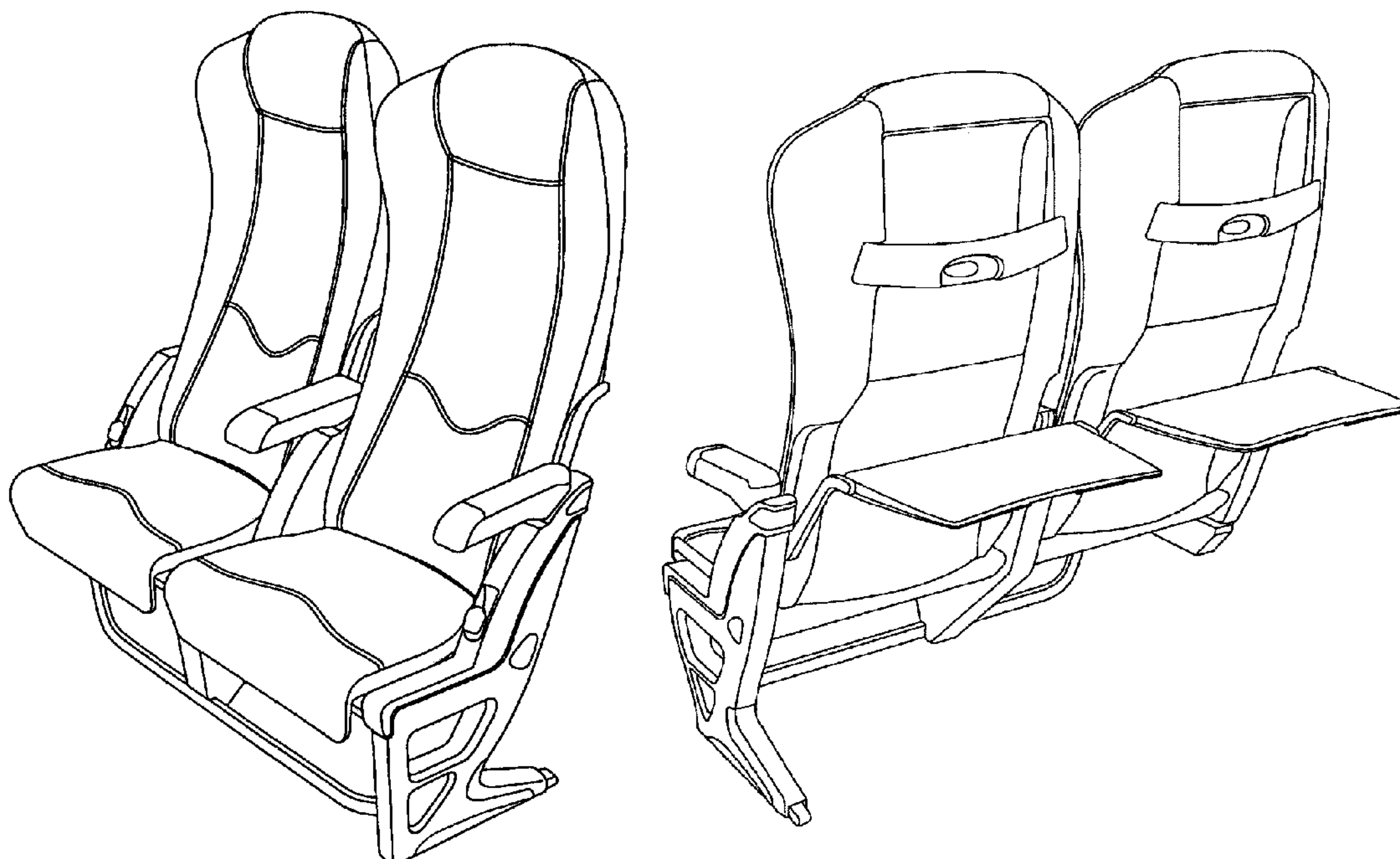

FIG. 1

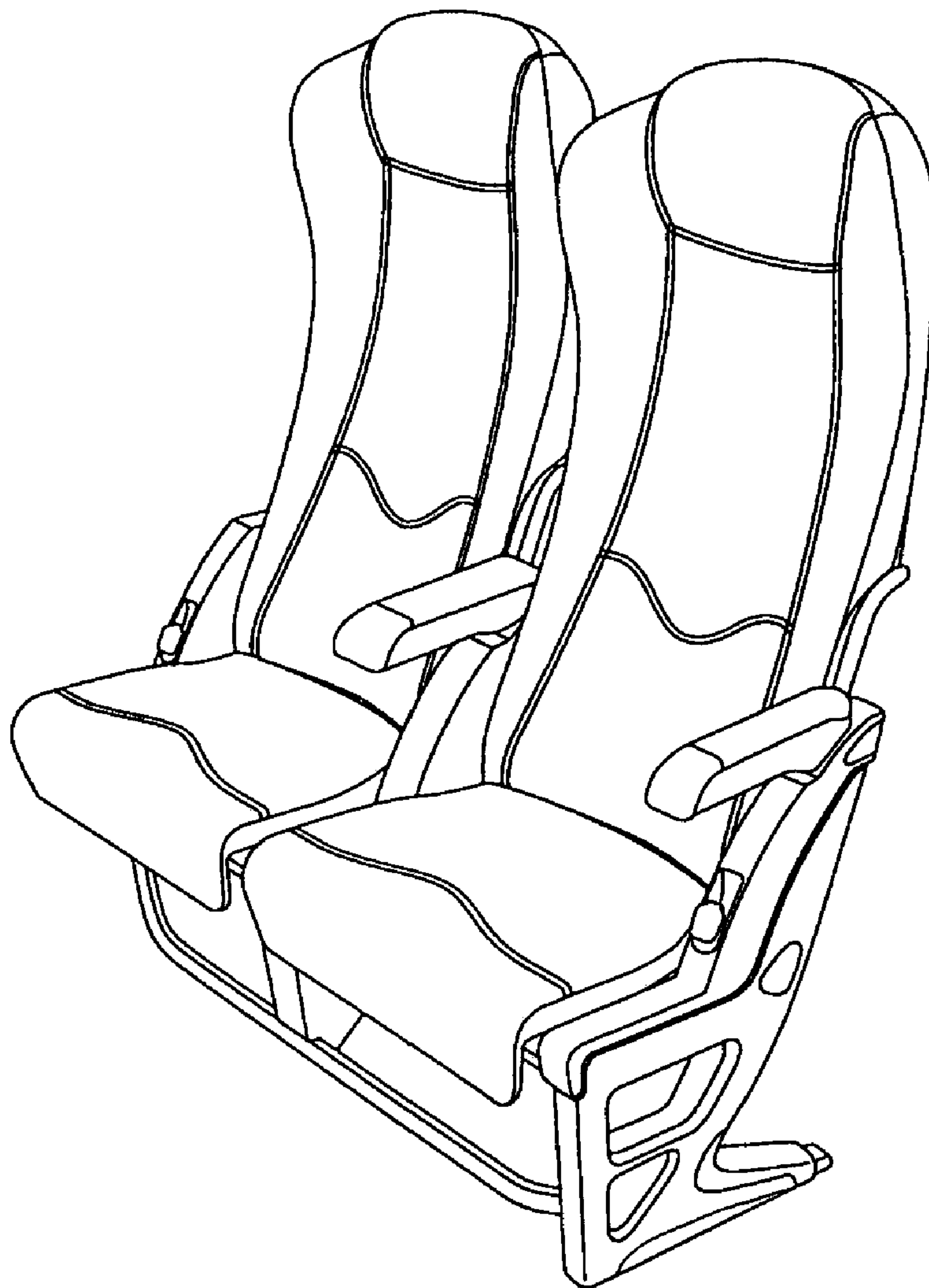

FIG. 2

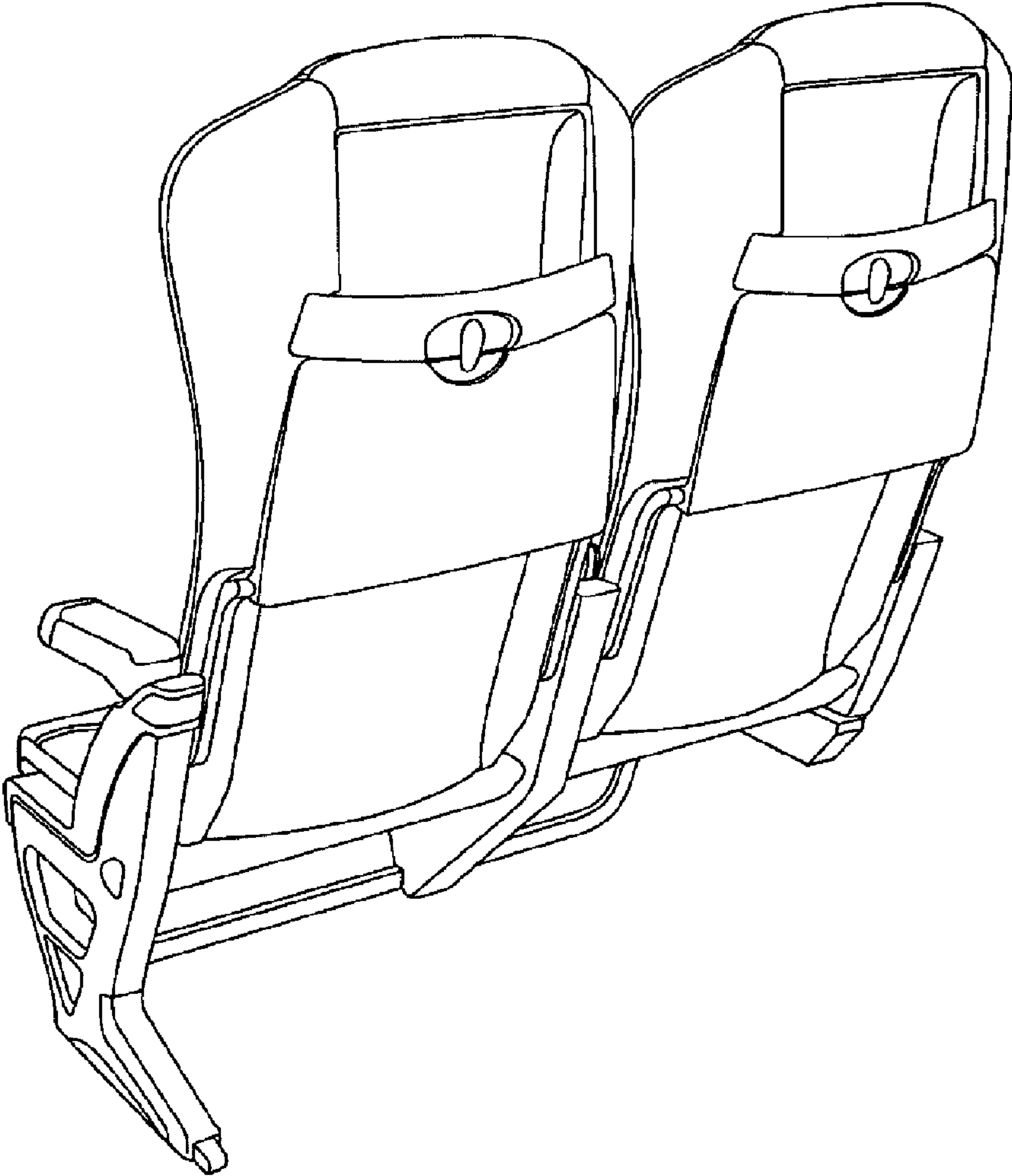

FIG. 3

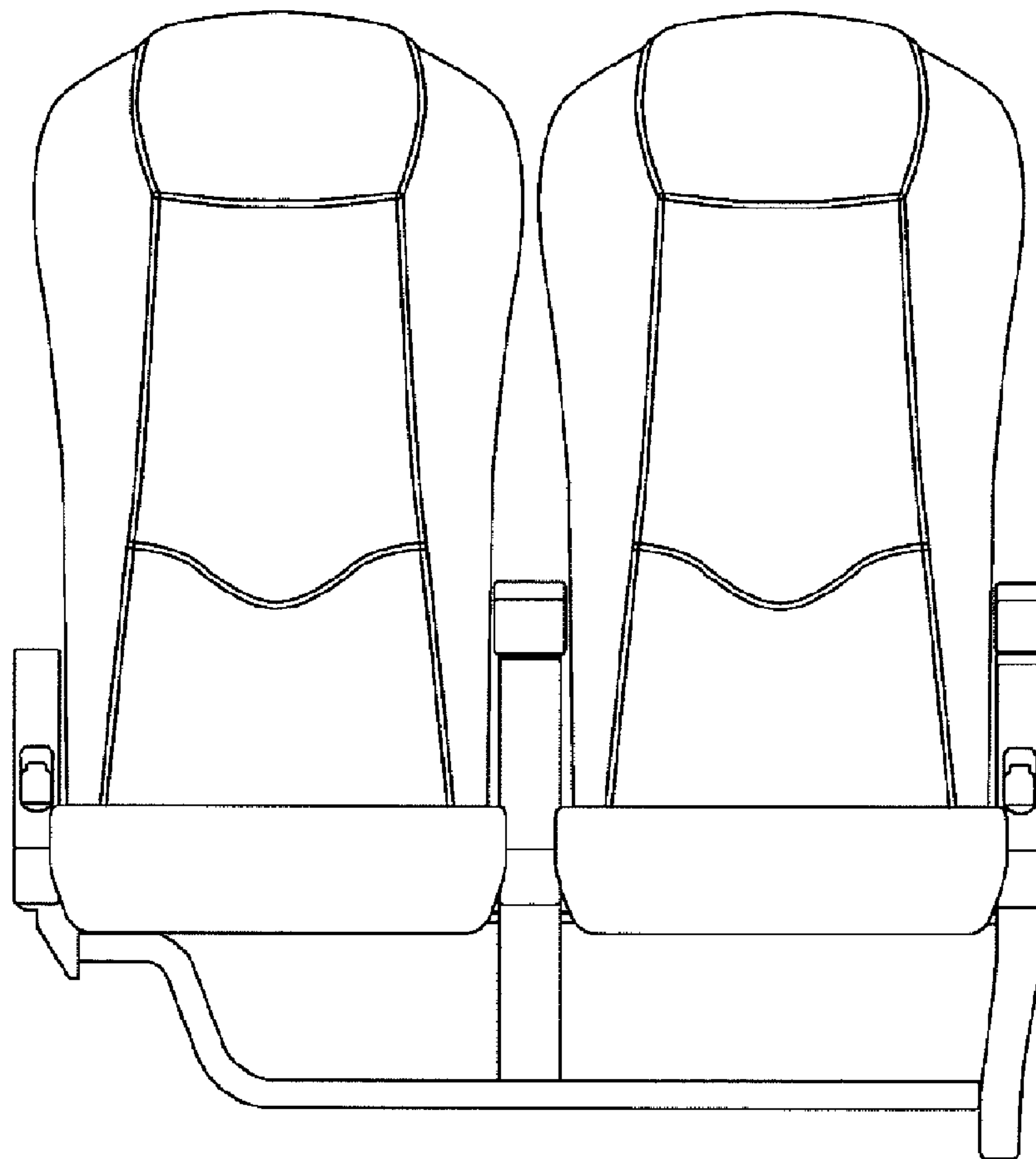

FIG. 4

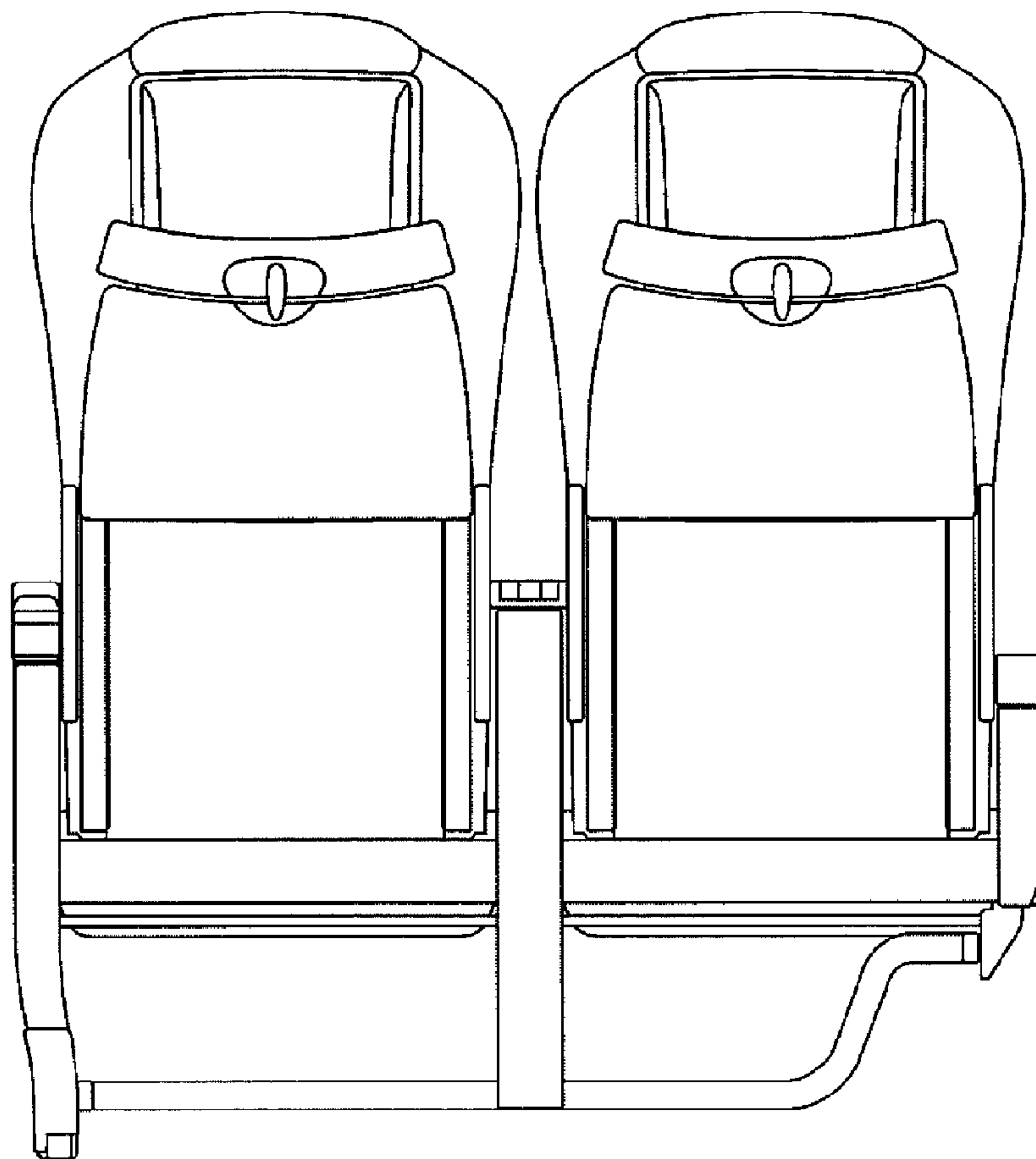

FIG. 5

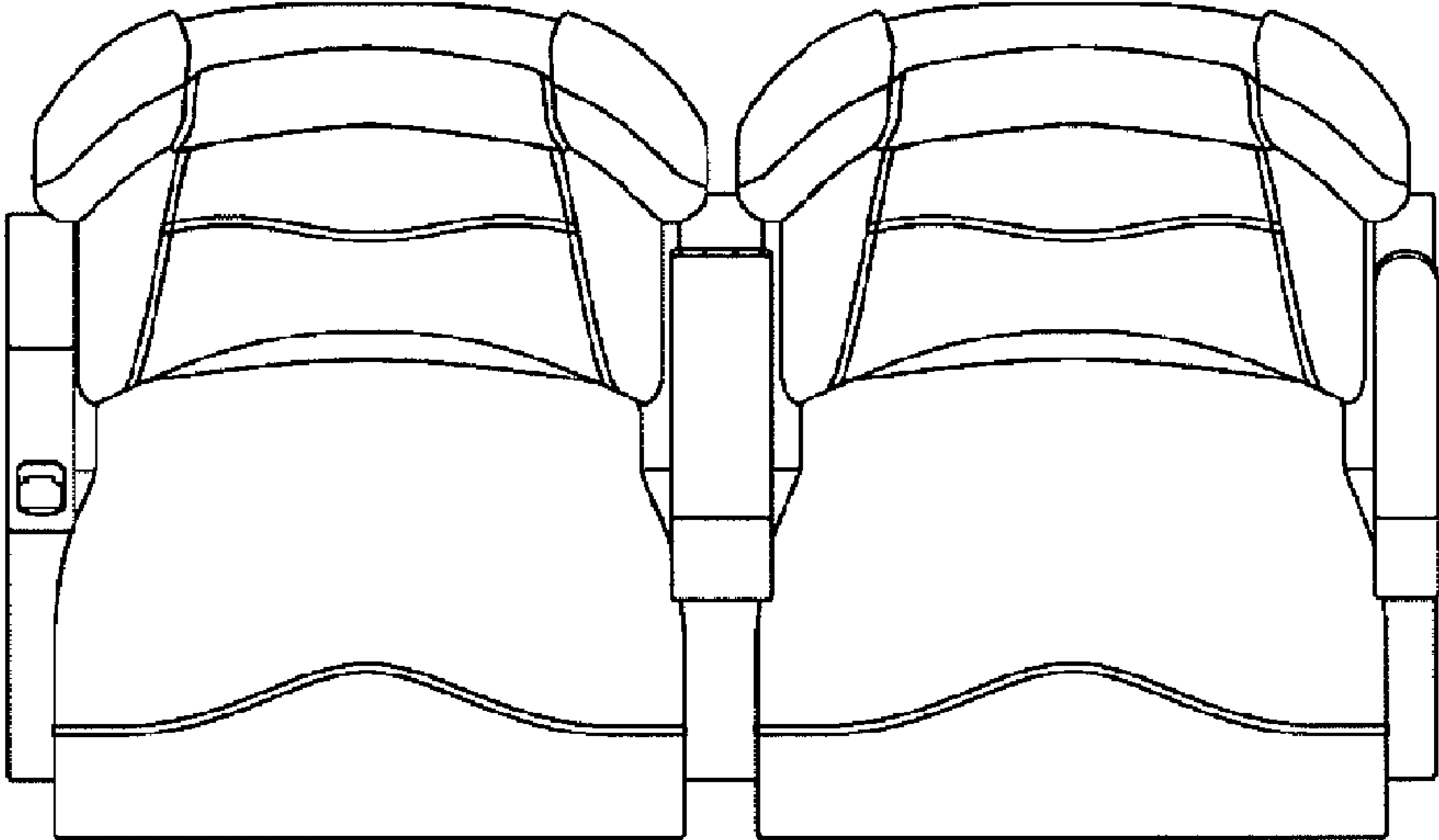

FIG. 6

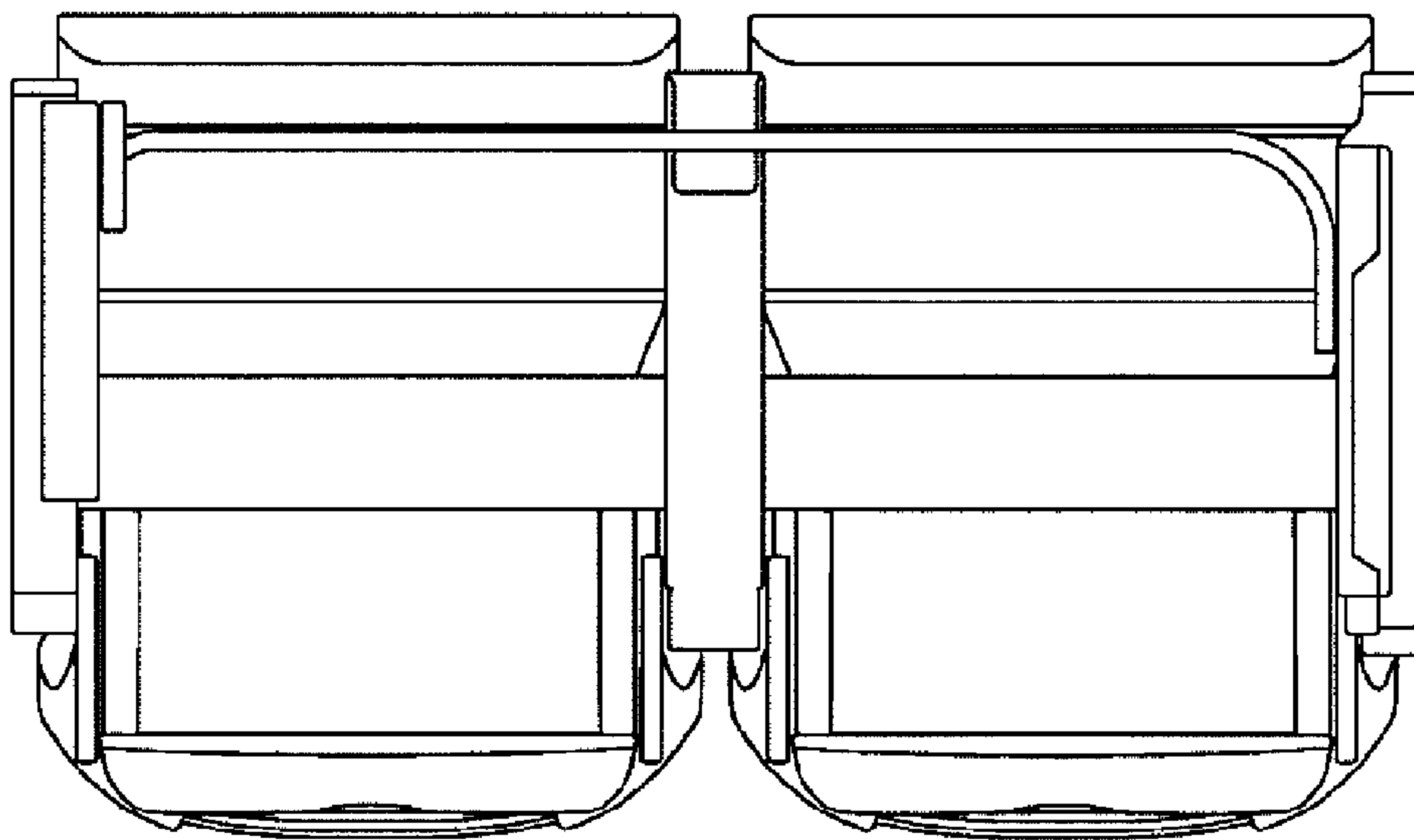

FIG. 7

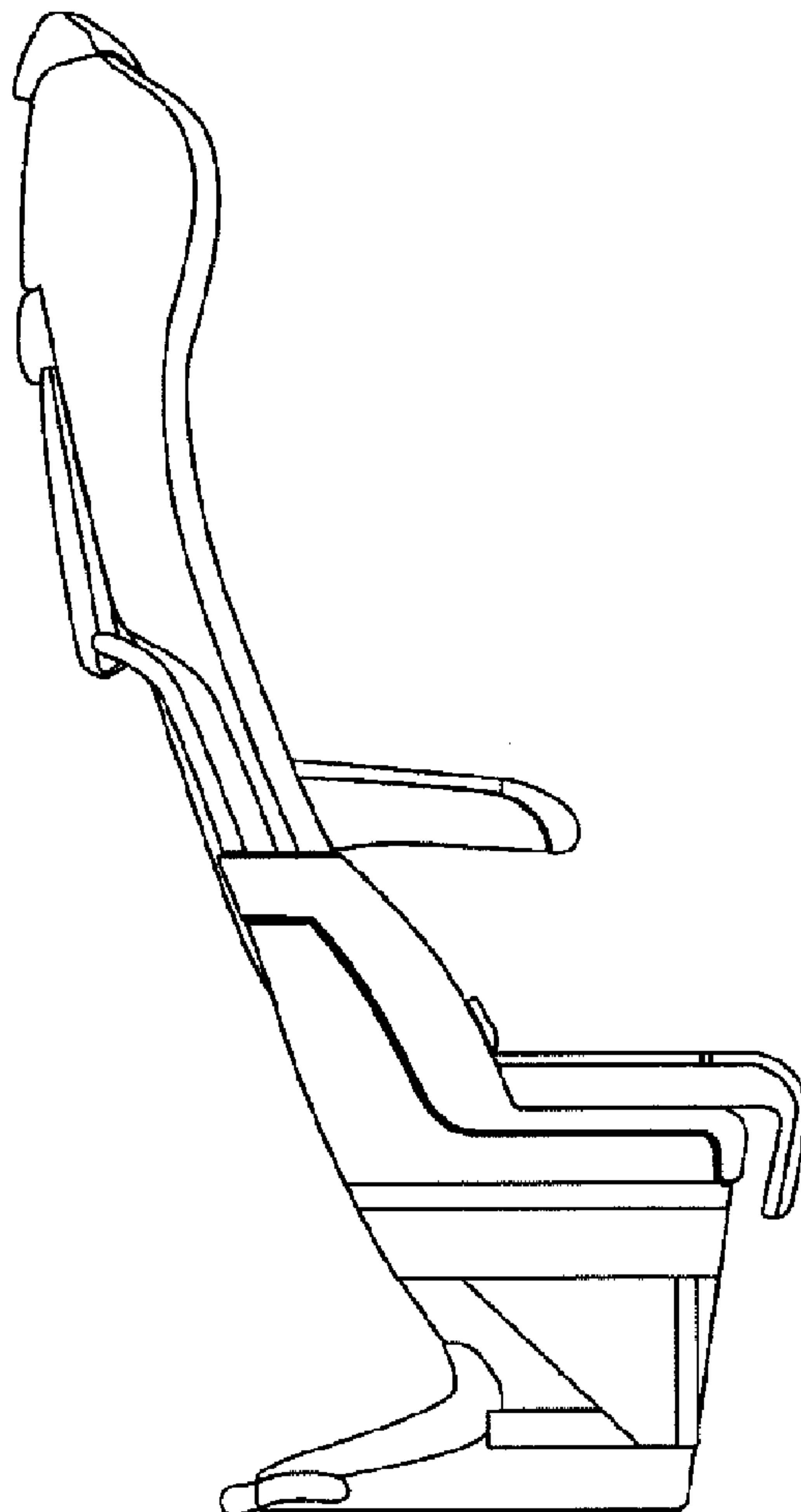

FIG. 8

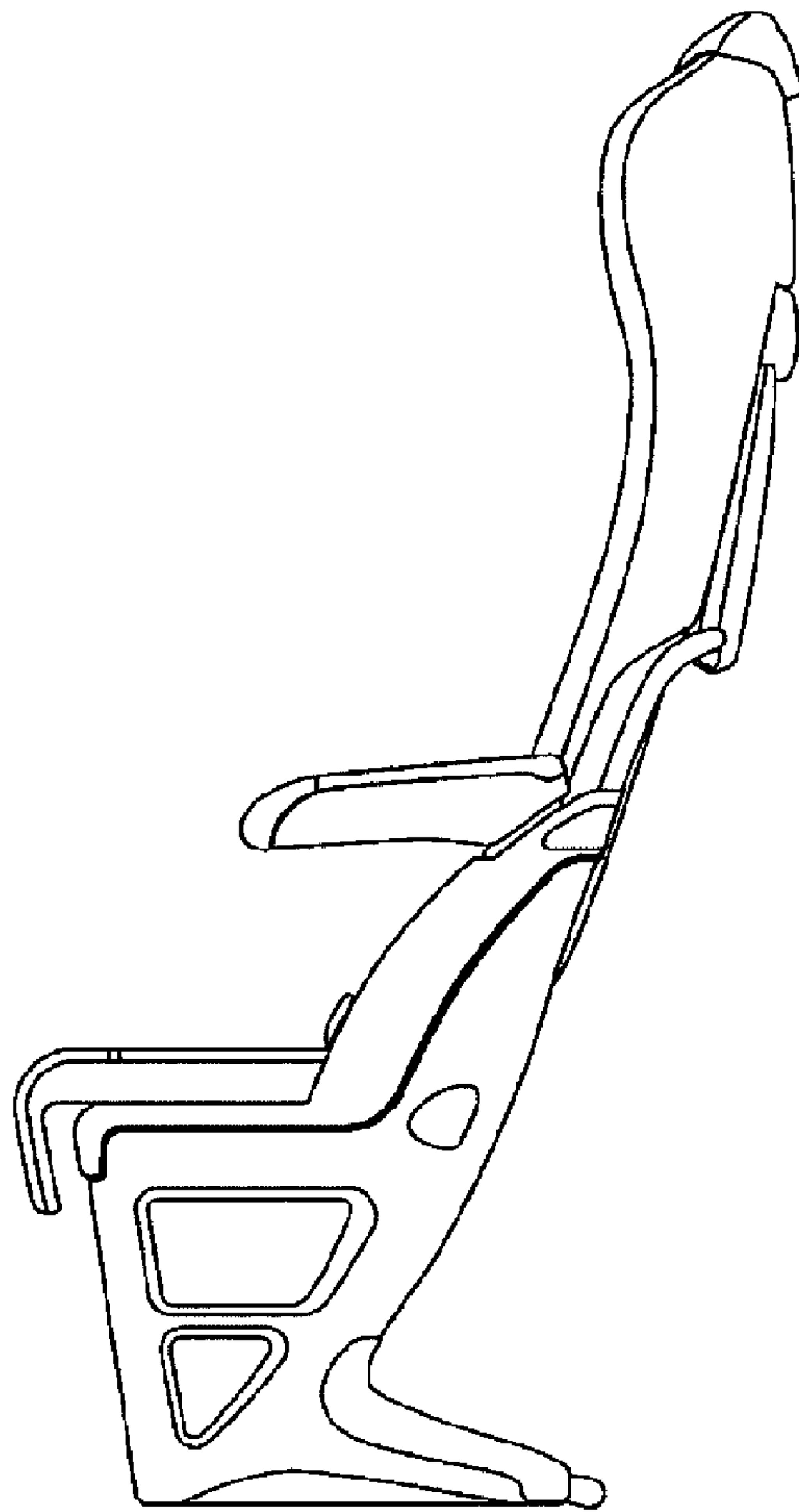

FIG. 9

