



US00D605815S

(12) **United States Design Patent**
Furuta

(10) **Patent No.:** **US D605,815 S**

(45) **Date of Patent:** **** Dec. 8, 2009**

(54) **SAFETY RAZOR HANDLE**

(75) Inventor: **Tatsuya Furuta, Seki (JP)**

(73) Assignee: **Kai R&D Center Co., Ltd., Gifu-ken (JP)**

(**) Term: **14 Years**

(21) Appl. No.: **29/311,536**

(22) Filed: **Apr. 16, 2009**

(30) **Foreign Application Priority Data**

Oct. 30, 2008 (JP) 2008-027990

(51) **LOC (9) Cl.** **28-03**

(52) **U.S. Cl.** **D28/48**

(58) **Field of Classification Search** 30/32,
30/34.05, 34.1, 34.2, 41-41.8, 44-45, 47-51,
30/53-58, 526-533; D28/44.1-48
See application file for complete search history.

(56) **References Cited**

U.S. PATENT DOCUMENTS

D408,101 S	4/1999	Shurtleff	
D476,772 S	7/2003	Wonderley	
D478,687 S	8/2003	Provost	
D495,826 S	9/2004	Ham et al.	
D500,170 S	* 12/2004	Jung D28/46
D506,035 S	6/2005	Dombrowski et al.	
D511,024 S	10/2005	Dombrowski et al.	
D516,244 S	2/2006	Efthimiadis et al.	
D525,391 S	7/2006	Gray et al.	
D537,203 S	2/2007	Provost	
D537,204 S	2/2007	Ramm et al.	
D541,476 S	4/2007	Rhoad et al.	
D563,047 S	2/2008	Ramm et al.	
D565,245 S	* 3/2008	Wonderley D28/46
D569,039 S	5/2008	Rhoad	

D569,040 S	5/2008	Micinilio et al.	
D569,551 S	5/2008	Micinilio et al.	
D581,595 S	* 11/2008	Micinillo et al. D28/48
D588,308 S	* 3/2009	Wonderley D28/46
D589,210 S	* 3/2009	Wonderley et al. D28/48
D593,711 S	* 6/2009	Yamamoto D28/48

FOREIGN PATENT DOCUMENTS

JP	S-1242354	6/2005
JP	S-1277321	7/2006
JP	S-1311395	10/2007
JP	S-1329756	5/2008
JP	S-1337026	8/2008

* cited by examiner

Primary Examiner—Jennifer Rivard

(74) *Attorney, Agent, or Firm*—Posz Law Group, PLC

(57) **CLAIM**

The ornamental design for a safety razor handle, as shown and described.

DESCRIPTION

FIG. 1 is a front perspective view of a safety razor handle showing my new design;

FIG. 2 is a rear perspective view thereof;

FIG. 3 is a front view thereof;

FIG. 4 is a rear view thereof;

FIG. 5 is a top plan view thereof, the bottom plan view being a mirror image of FIG. 5;

FIG. 6 is an enlarged right side view thereof; and,

FIG. 7 is an enlarged left side view thereof.

The broken lines are shown for illustrative purposes only and form no part of the claimed design.

1 Claim, 4 Drawing Sheets

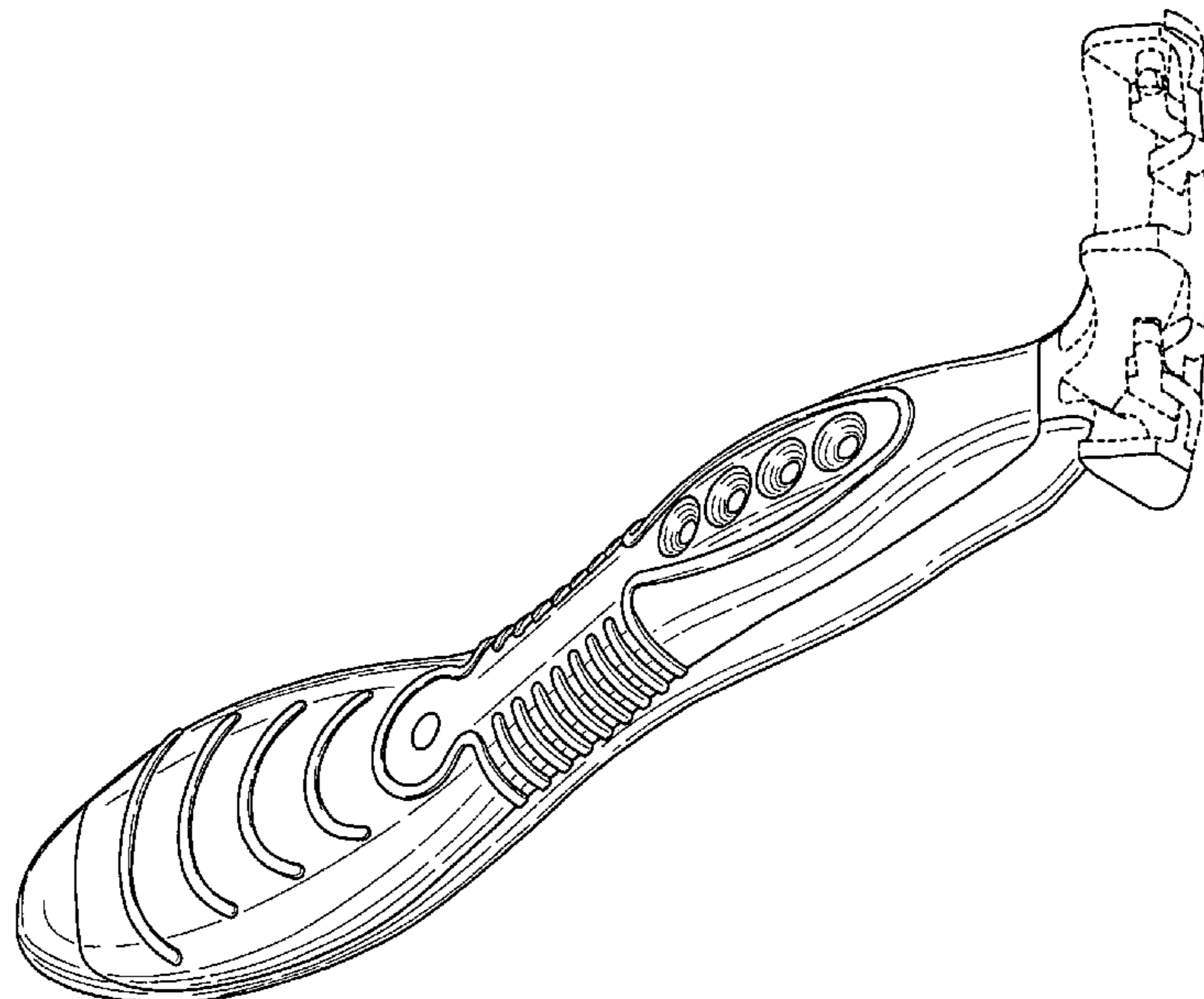
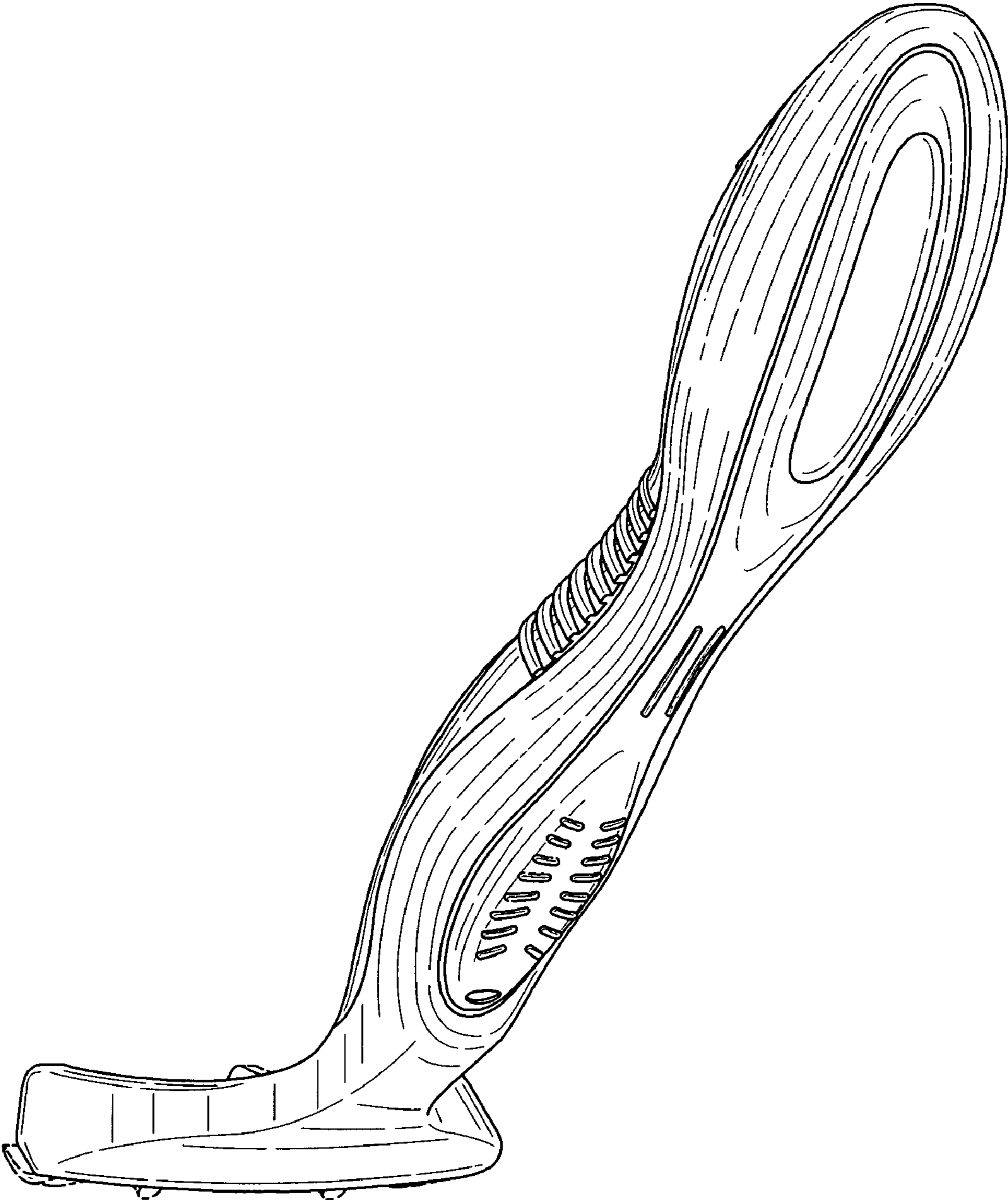

FIG. 1



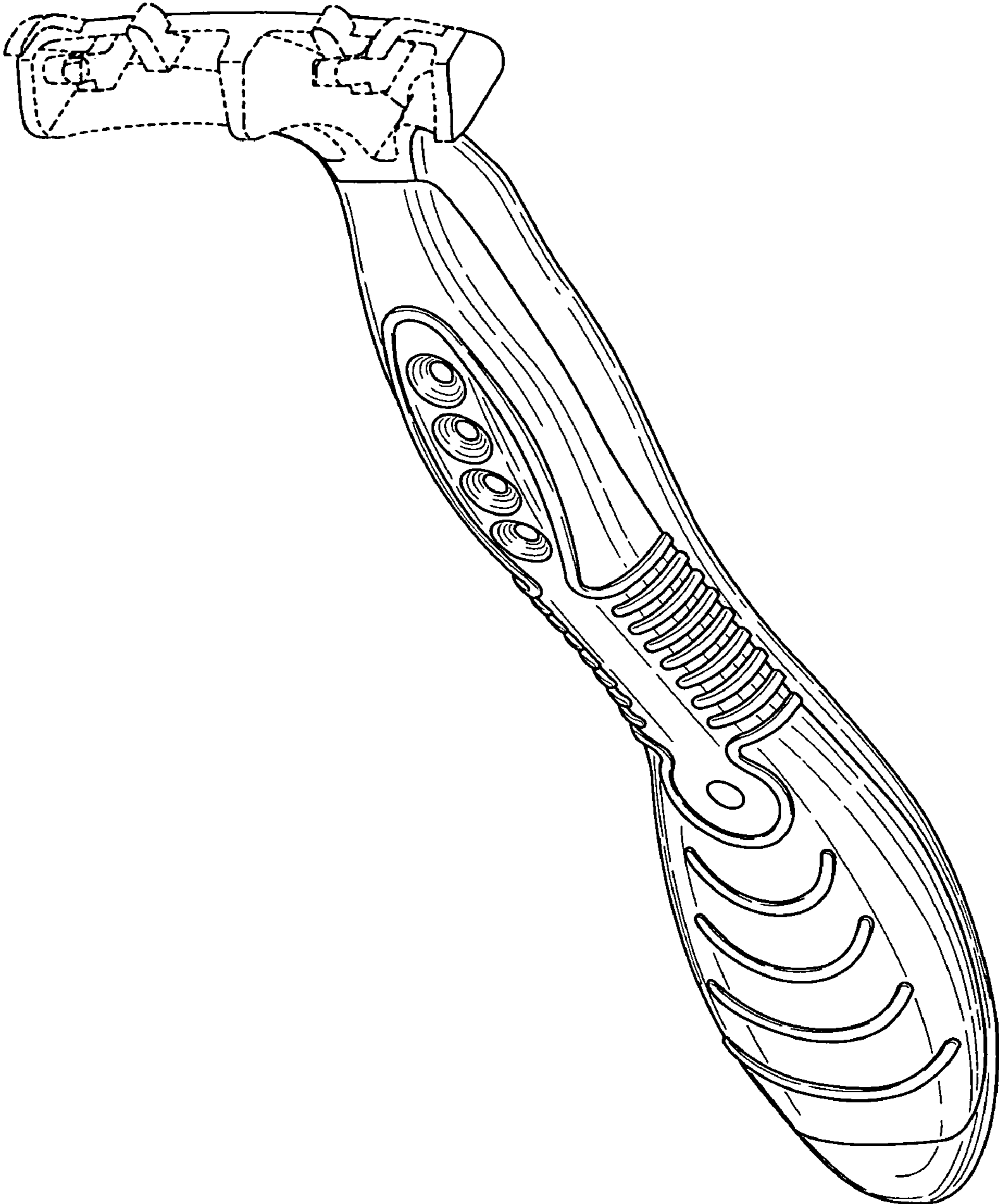

FIG. 2

FIG. 3

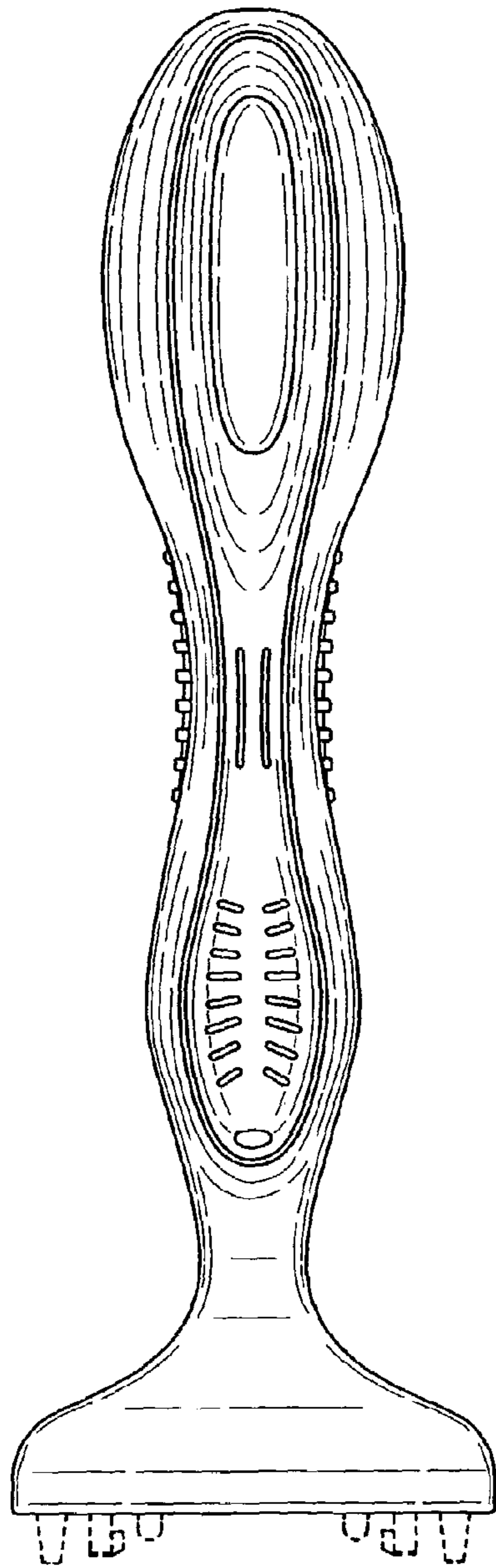

FIG. 4

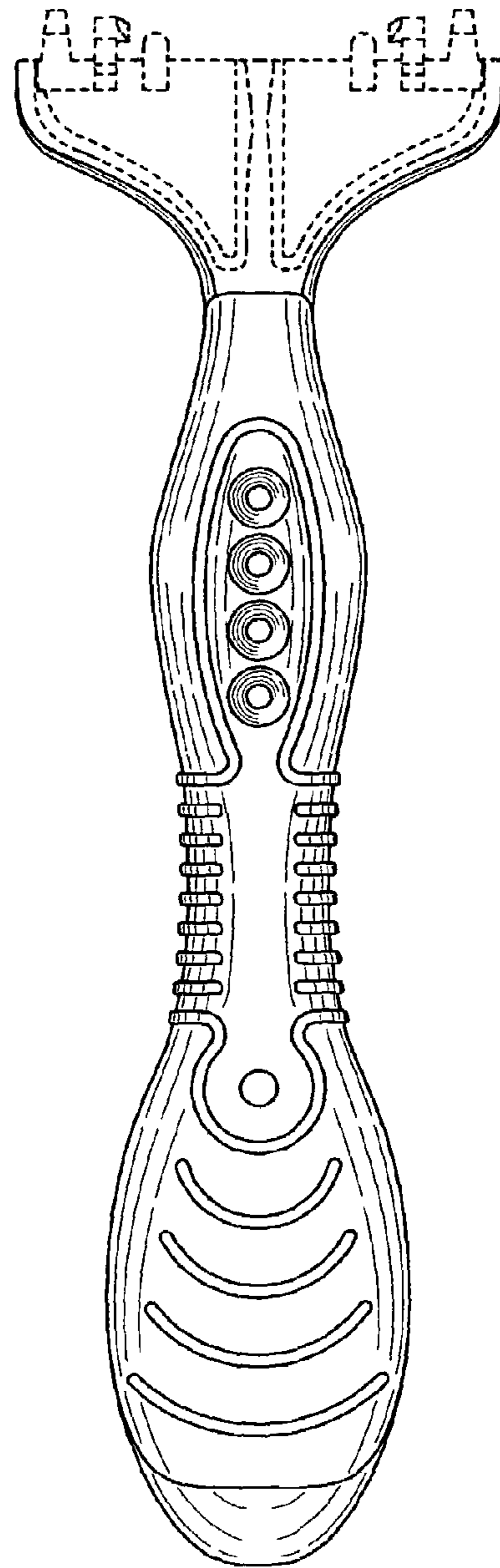

FIG. 5

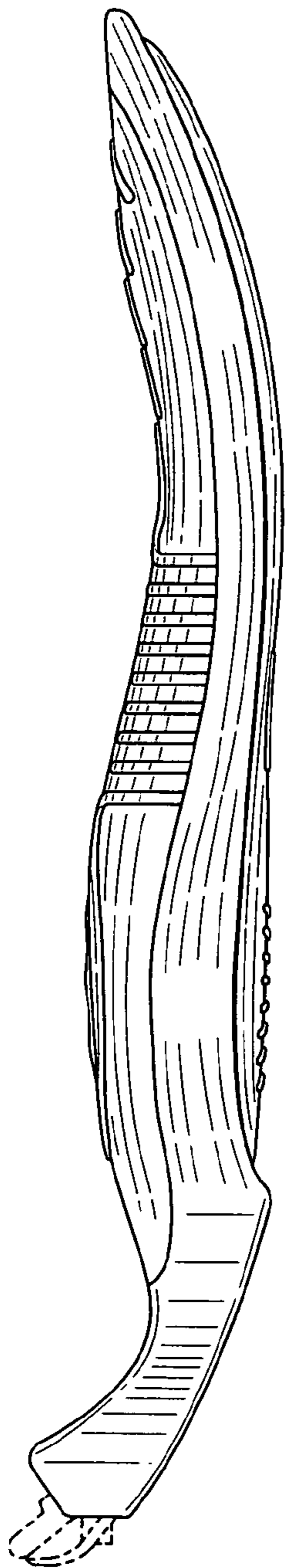

FIG. 6

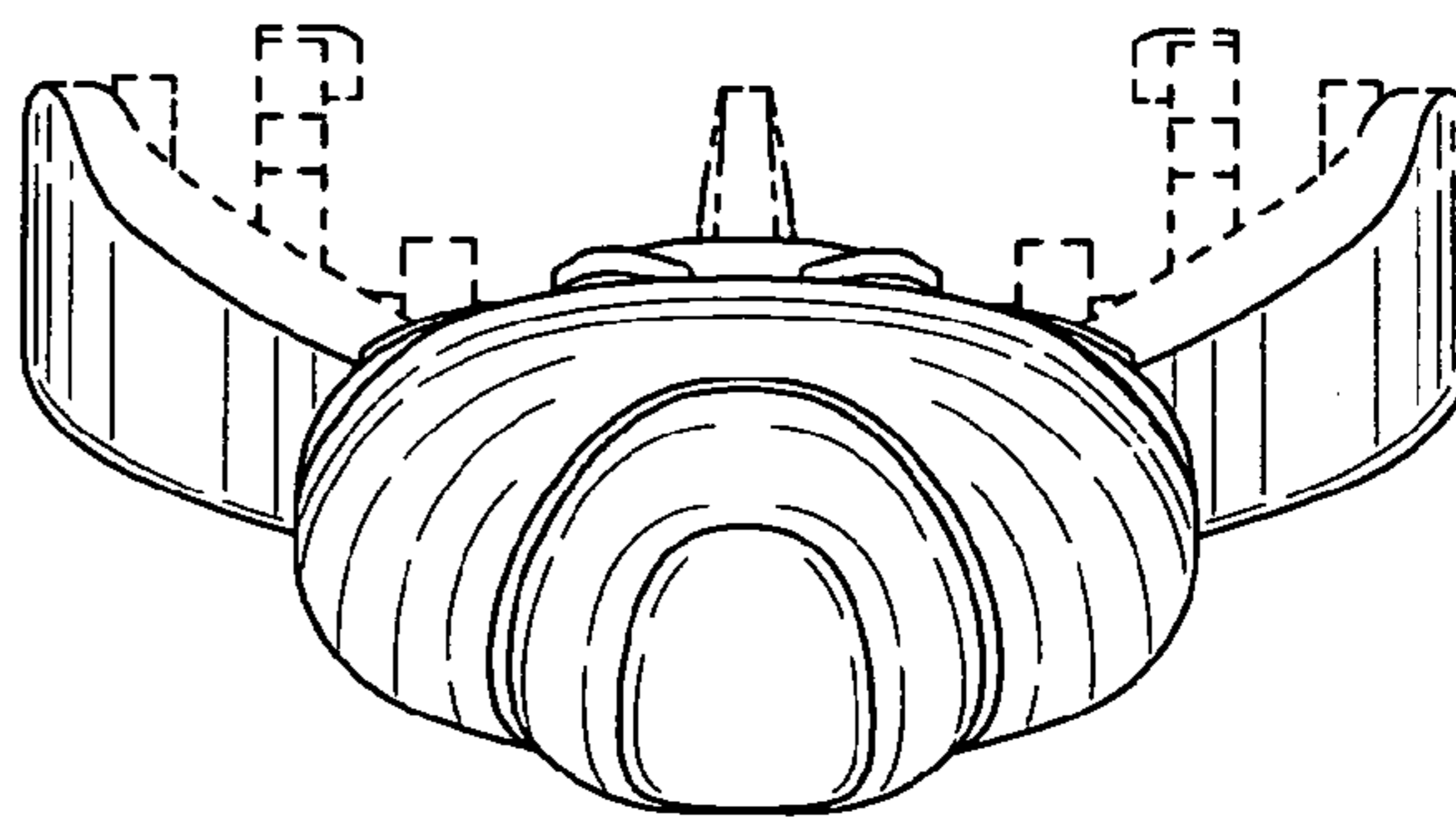

FIG. 7

