



US00D605784S

(12) **United States Design Patent**  
**Waters et al.**

(10) **Patent No.:** **US D605,784 S**

(45) **Date of Patent:** **\*\* Dec. 8, 2009**

(54) **CEILING PANEL**

D575,934 S \* 9/2008 Killinger ..... D2/853  
2008/0245019 A1 \* 10/2008 Vilar Llop et al. .... 52/586.1

(75) Inventors: **James R. Waters**, Lancaster, PA (US);  
**Eric Krantz-Lilienthal**, Lancaster, PA (US)

\* cited by examiner

*Primary Examiner*—T. Chase Nelson  
*Assistant Examiner*—Michael A Pratt

(73) Assignee: **AWI Licensing Company**, Wilmington, DE (US)

(57) **CLAIM**

(\*\*) Term: **14 Years**

The ornamental design for a ceiling panel, as shown.

(21) Appl. No.: **29/263,307**

**DESCRIPTION**

(22) Filed: **Jul. 20, 2006**

(51) **LOC (9) Cl.** ..... **25-01**

(52) **U.S. Cl.** ..... **D25/140**

(58) **Field of Classification Search** ..... D25/139,  
D25/140, 141, 143, 144, 150, 163; 428/47,  
428/48, 49, 77, 141, 142, 143, 194; 52/518,  
52/546, 554, 555, 557, 559

See application file for complete search history.

FIG. 1 is a front perspective view of Embodiment 1:

FIG. 2 is a front perspective view thereof;

FIG. 3 is a front a perspective view thereof;

FIG. 4 is a front perspective view thereof;

FIG. 5 is a front perspective view thereof;

FIG. 6 a bottom plan view thereof;

FIG. 7 is a front perspective view of Embodiment 2;

FIG. 8 is a bottom plan view thereof;

FIG. 9 is a front perspective view of Embodiment 3;

FIG. 10 is a bottom plan view thereof;

FIG. 11 is a front perspective view Embodiment 4;

FIG. 12 is a bottom plan view thereof;

FIG. 13 is a front perspective view of Embodiment 5;

FIG. 14 is a bottom plan view thereof;

FIG. 15 is front perspective view Embodiment 6; and,

FIG. 16 is a bottom plan view thereof.

The broken line showing of suspension hardware and similar panels which form a directional curved array ceiling pattern with integrated lighting is included for the purpose of illustrating environment and forms no part of the claimed design.

(56) **References Cited**

U.S. PATENT DOCUMENTS

888,530	A *	5/1908	Pugh	.....	52/311.2
958,095	A *	5/1910	Coleman	.....	52/411
1,657,271	A *	1/1928	Nelson	.....	52/554
1,729,212	A *	9/1929	Fischer	.....	52/555
3,120,083	A *	2/1964	Dahlberg et al.	.....	52/596
D200,312	S *	2/1965	Monroe	.....	D25/158
3,977,928	A *	8/1976	Odagiri et al.	.....	156/62.2
4,583,341	A *	4/1986	Barth et al.	.....	52/591.1
4,773,790	A *	9/1988	Hagenah	.....	404/41
5,743,059	A *	4/1998	Fifield	.....	52/519
D399,978	S *	10/1998	Barth et al.	.....	D25/113
6,171,015	B1 *	1/2001	Barth et al.	.....	404/34
D464,737	S *	10/2002	Gulbrandsen et al.	.....	D25/58
D474,550	S *	5/2003	Wendt	.....	D25/138
7,182,989	B2 *	2/2007	Higgins et al.	.....	428/51
D569,012	S *	5/2008	Ellis	.....	D25/138

**1 Claim, 16 Drawing Sheets**

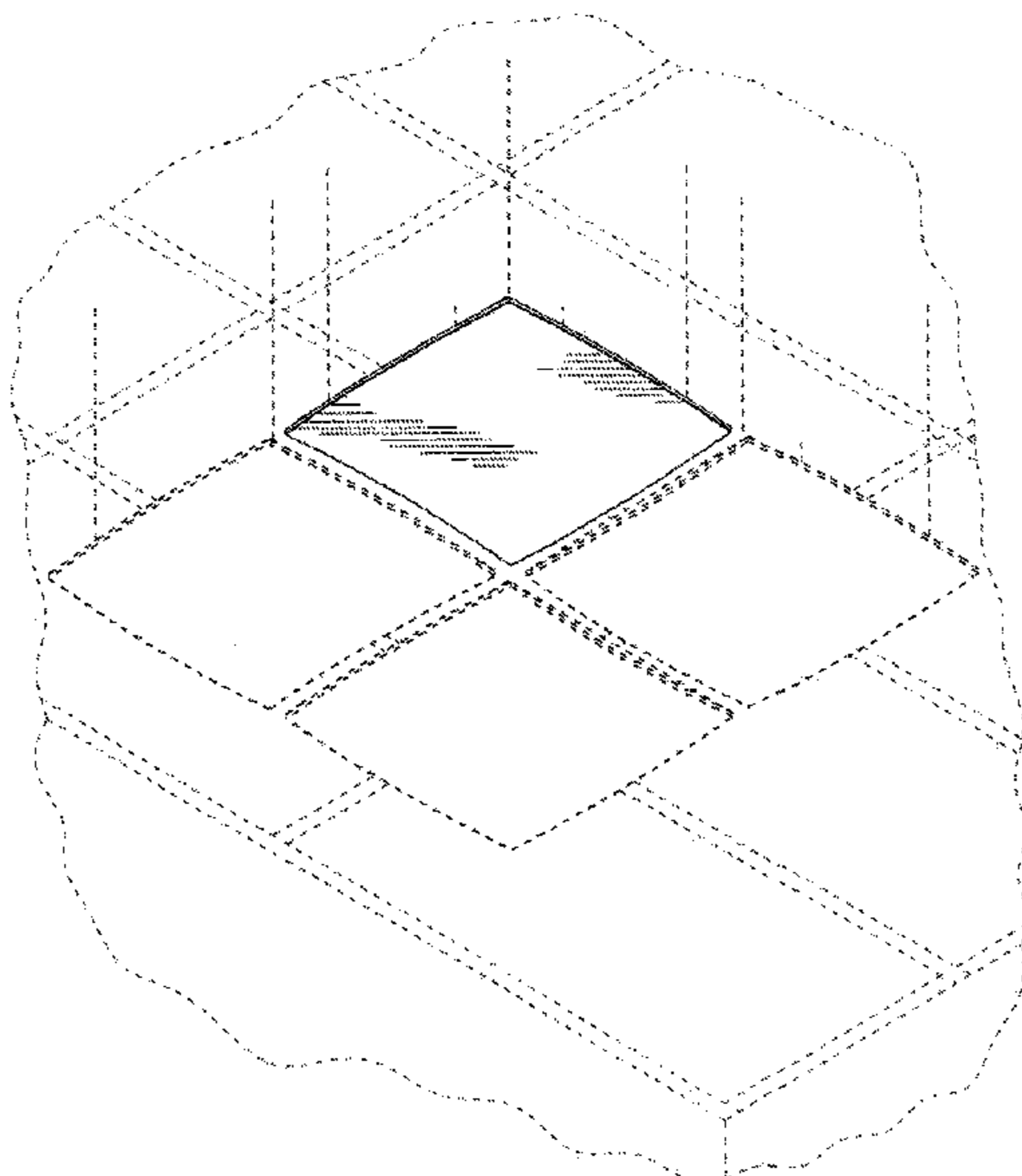

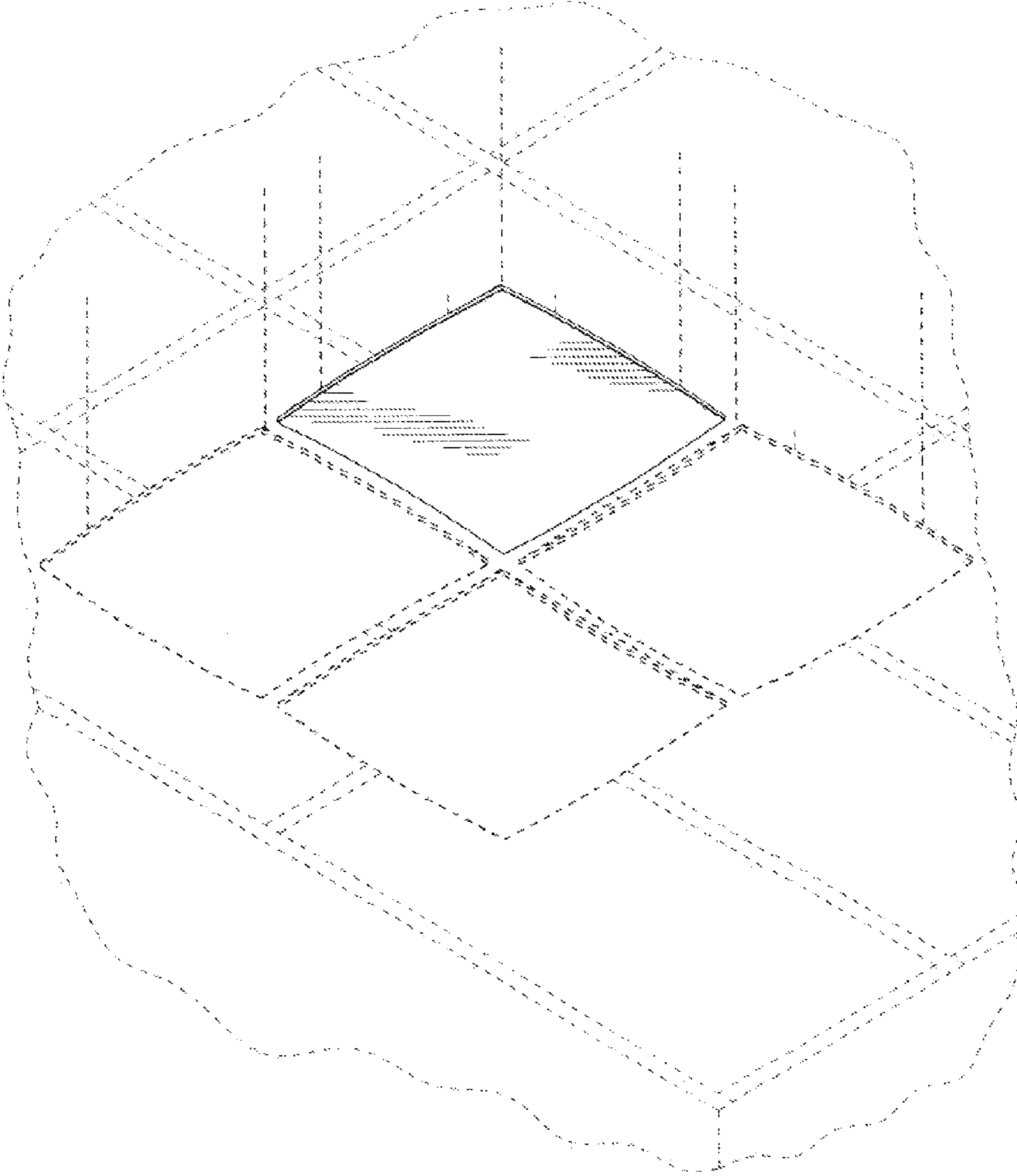

Figure 1

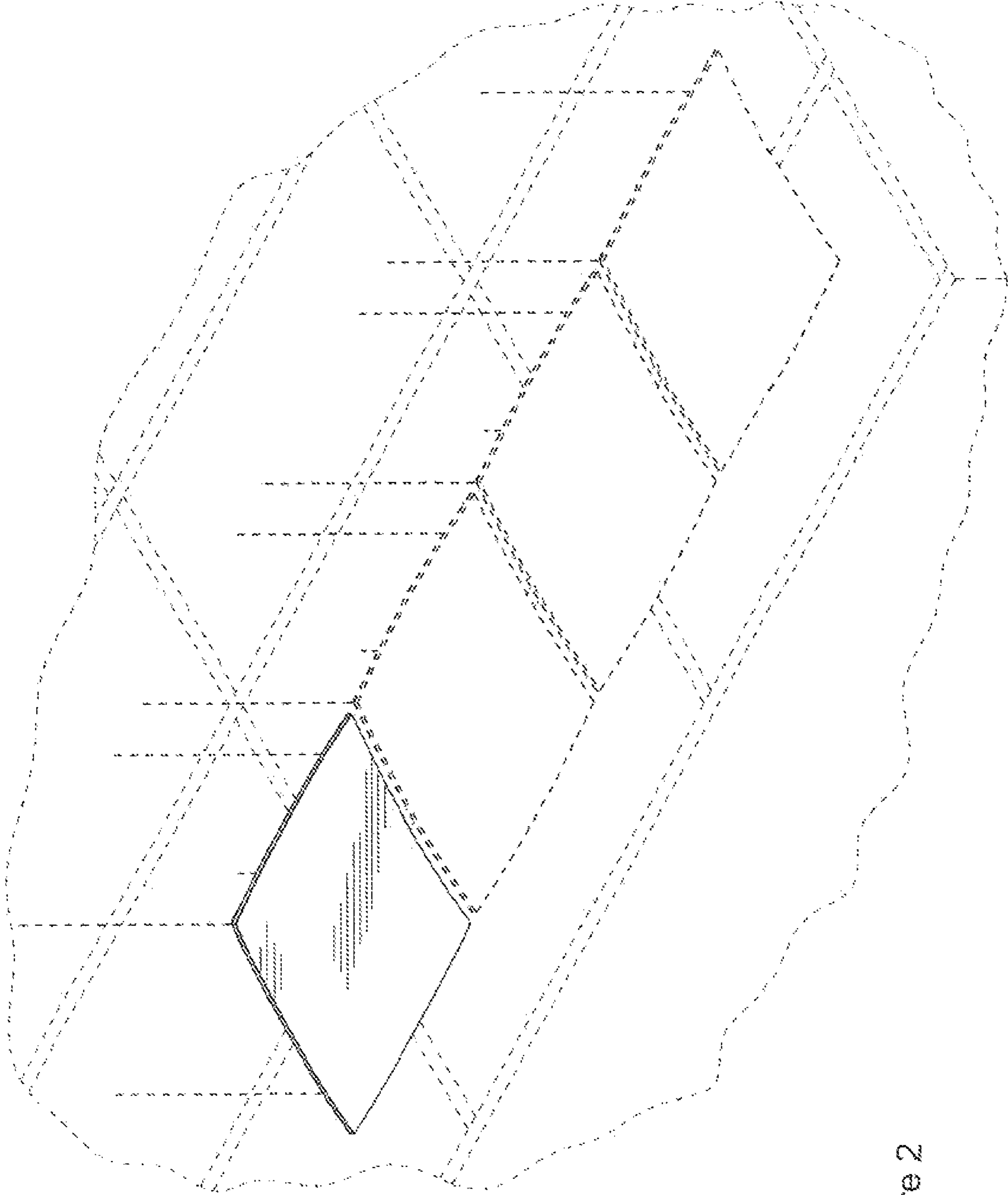

Figure 2

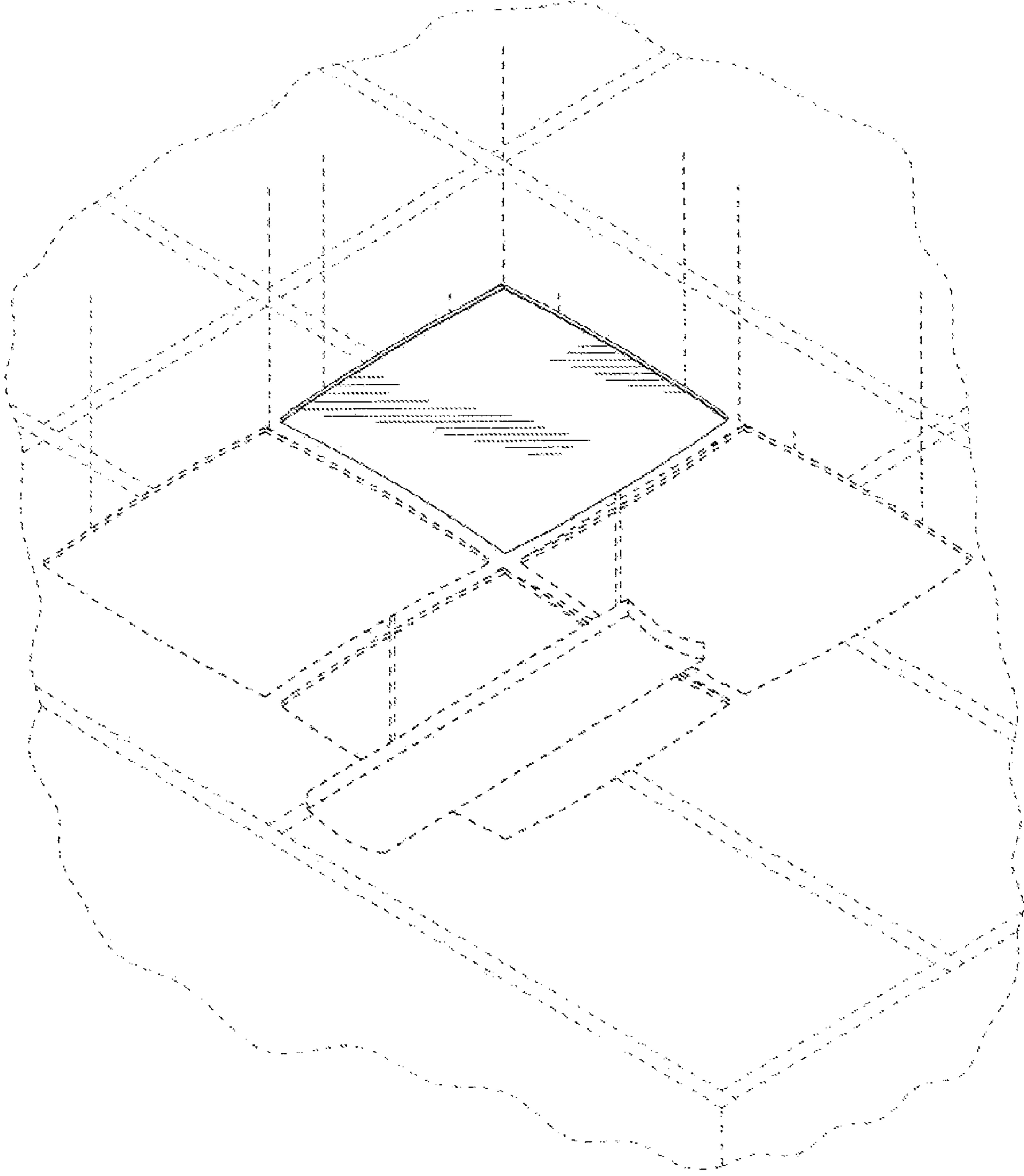

Figure 3

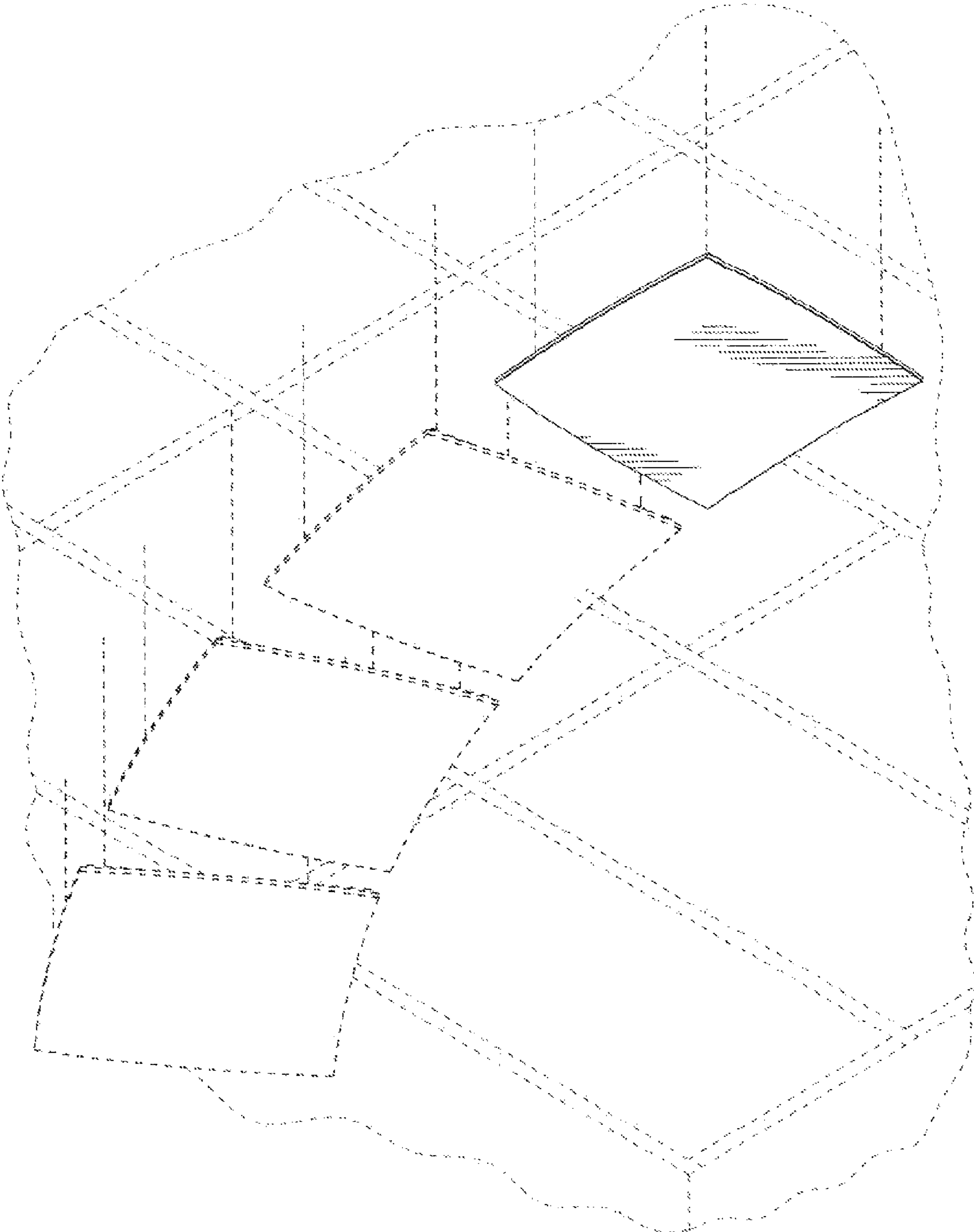

Figure 4

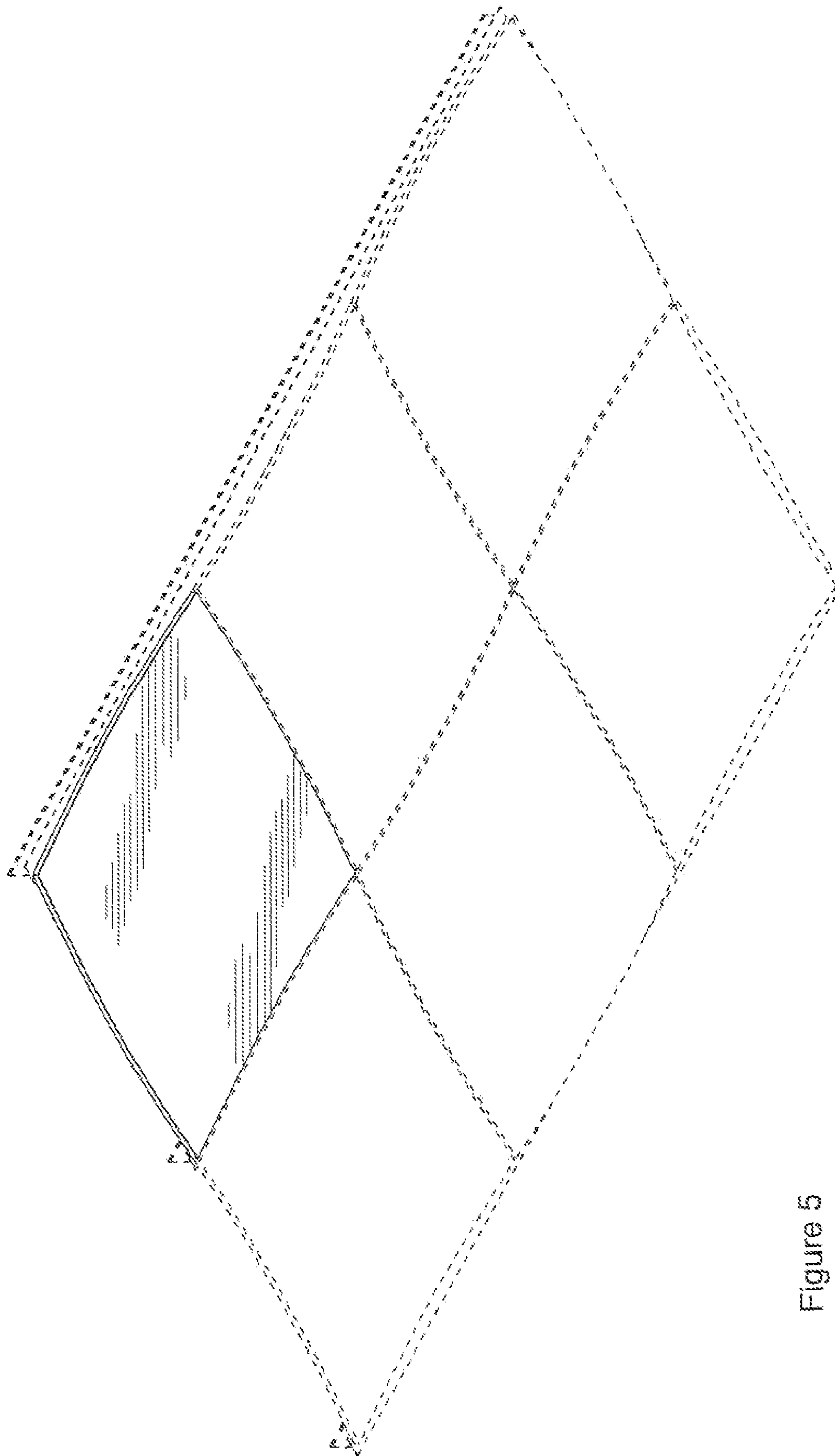
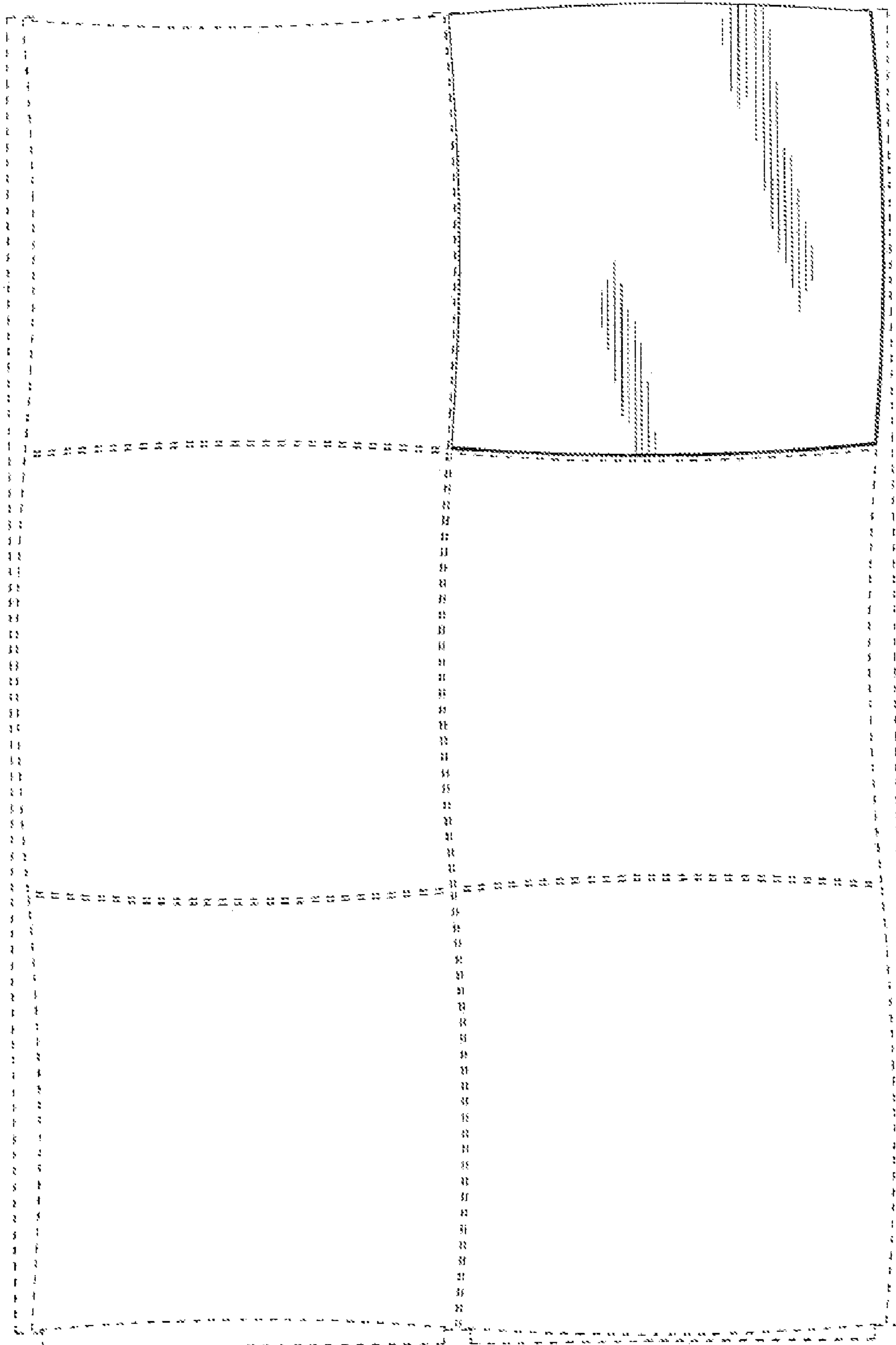

Figure 5

Figure 6



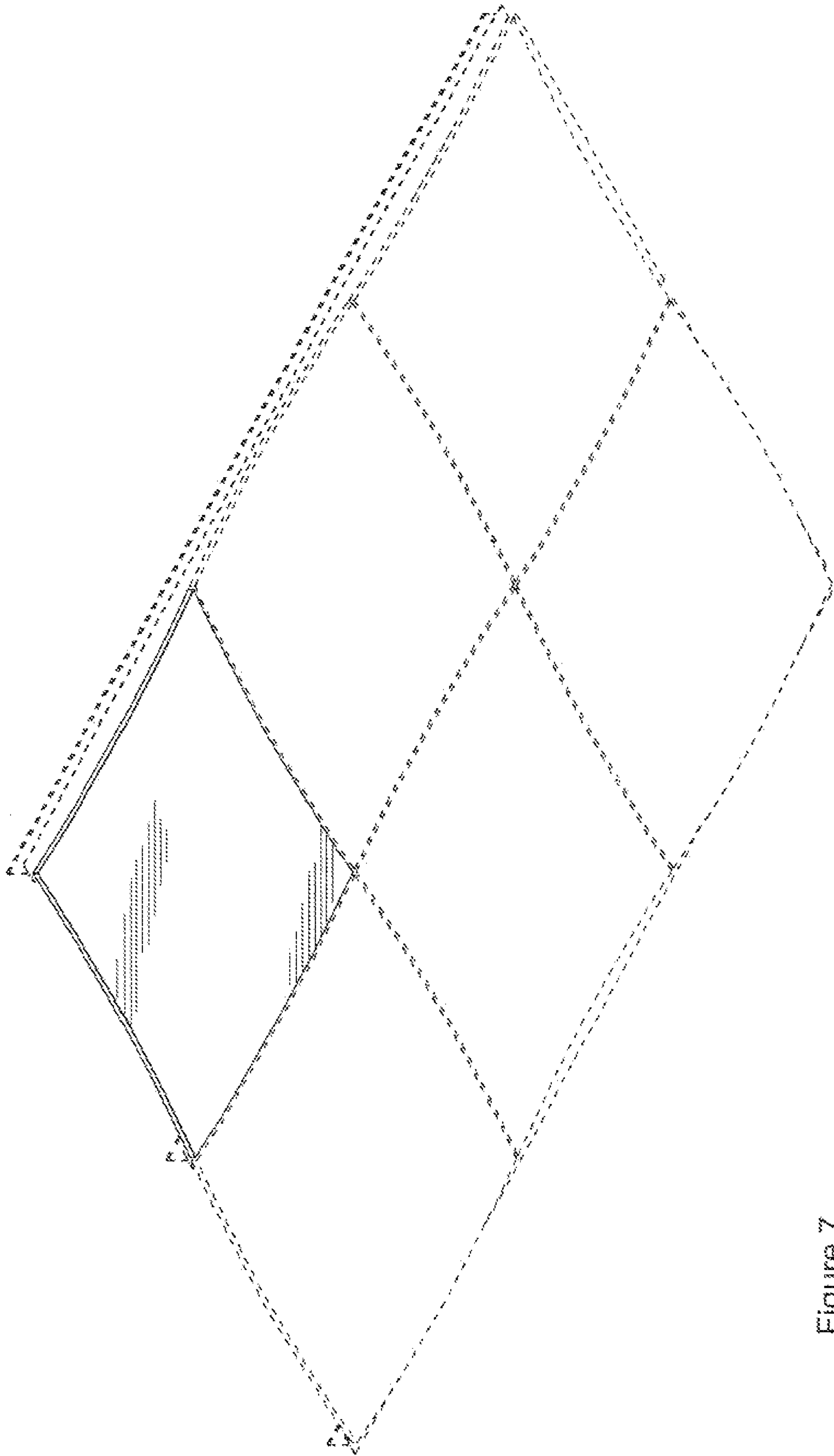
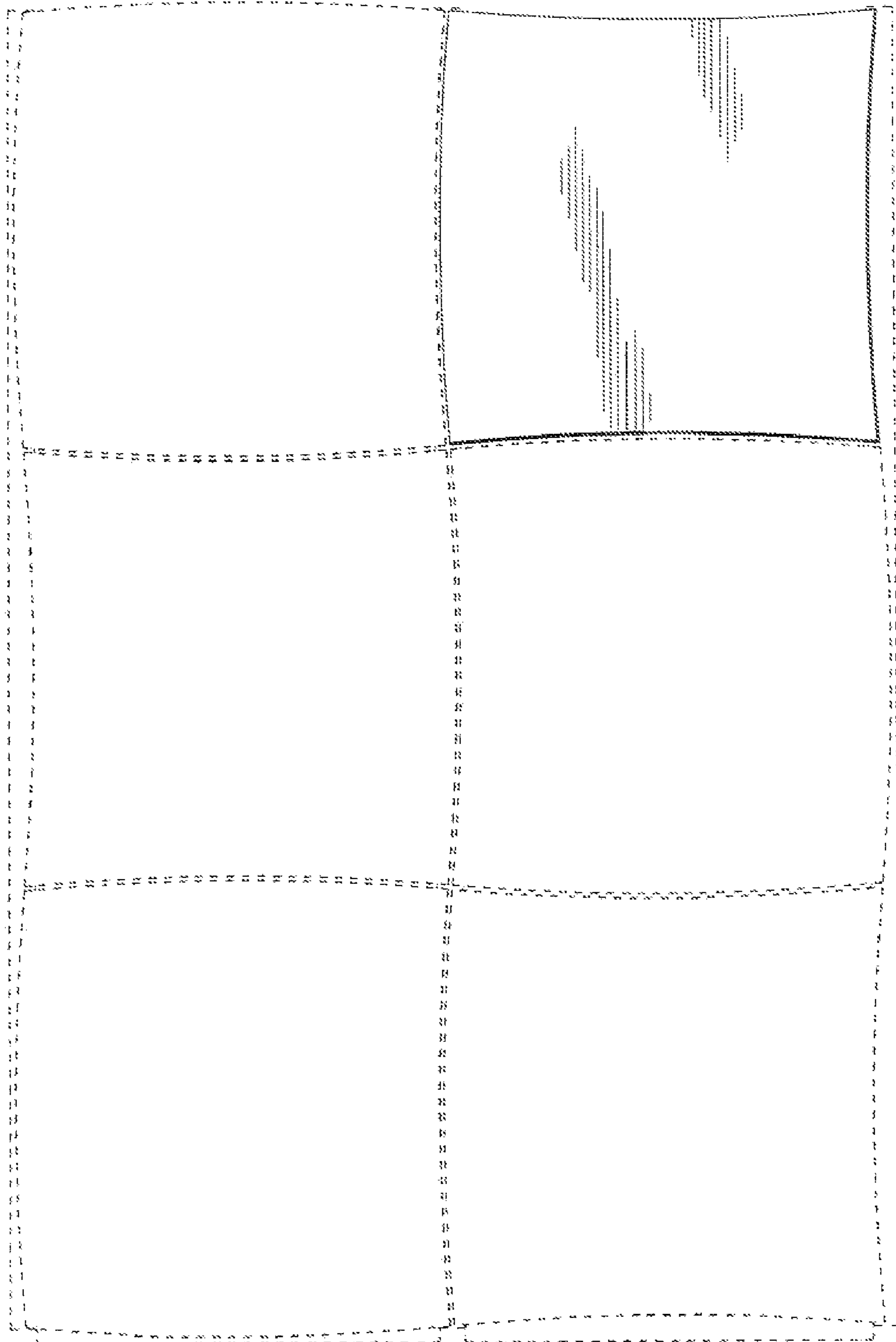

Figure 7



Figure 8



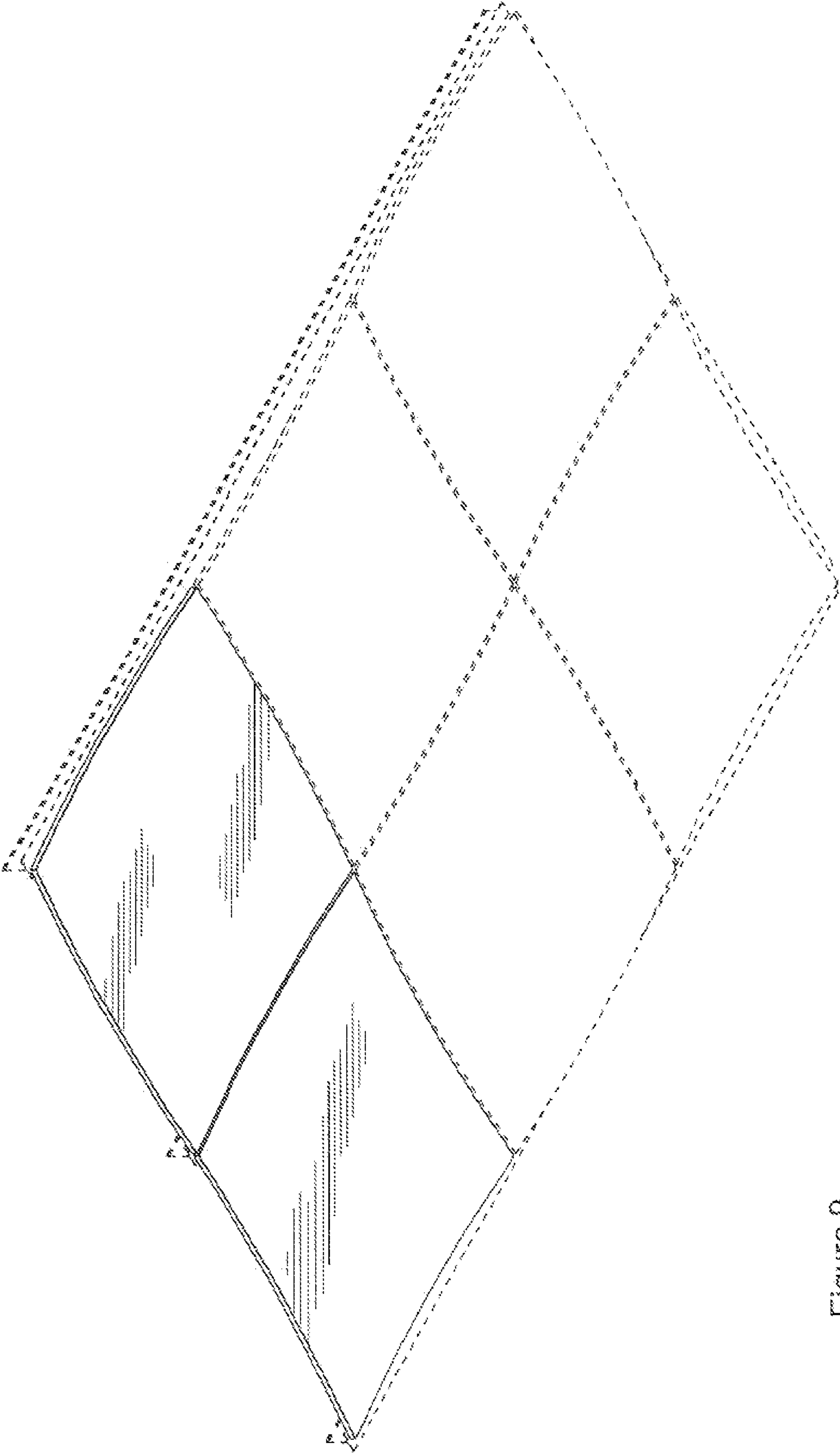
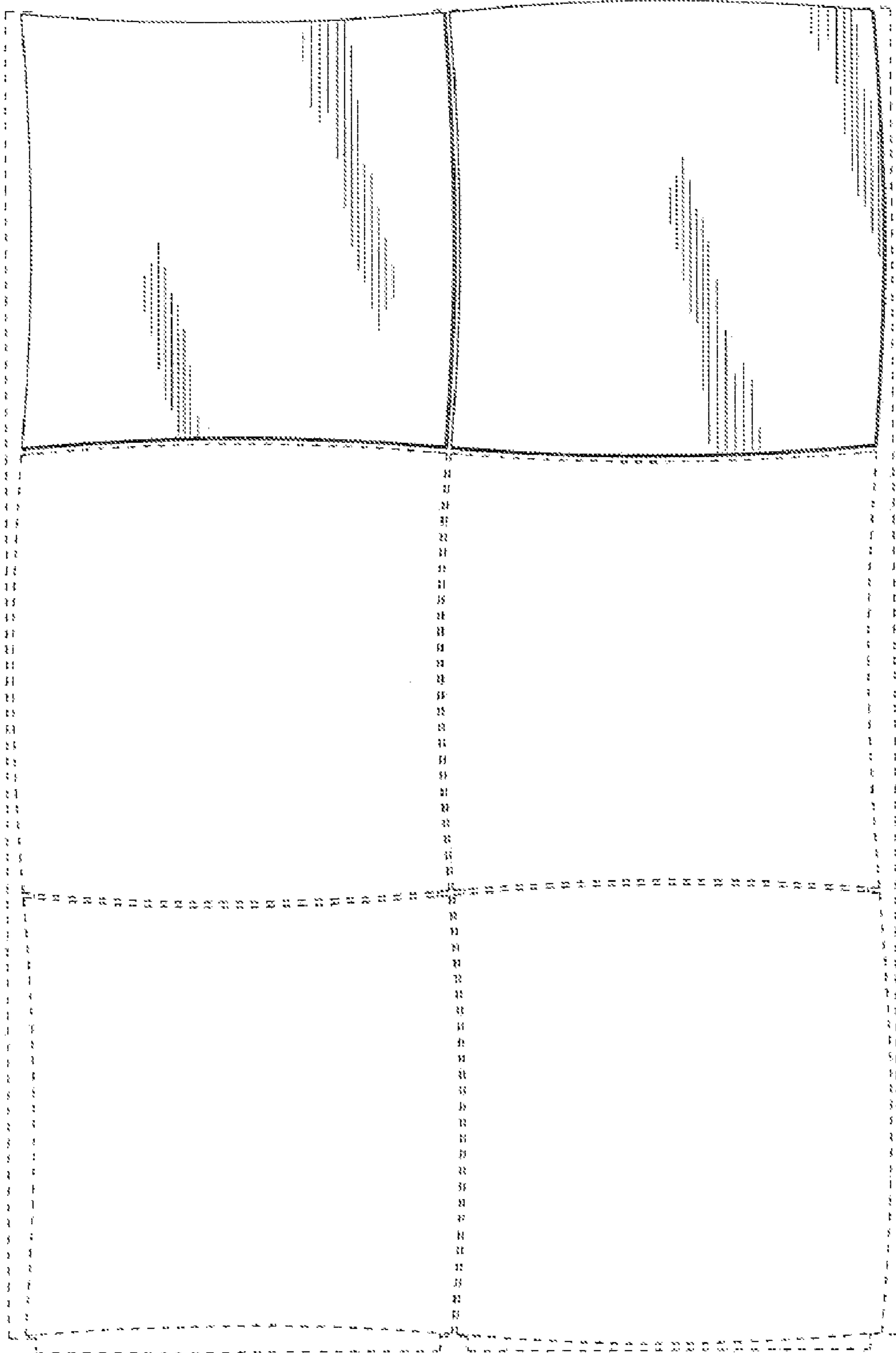

Figure 9

Figure 10



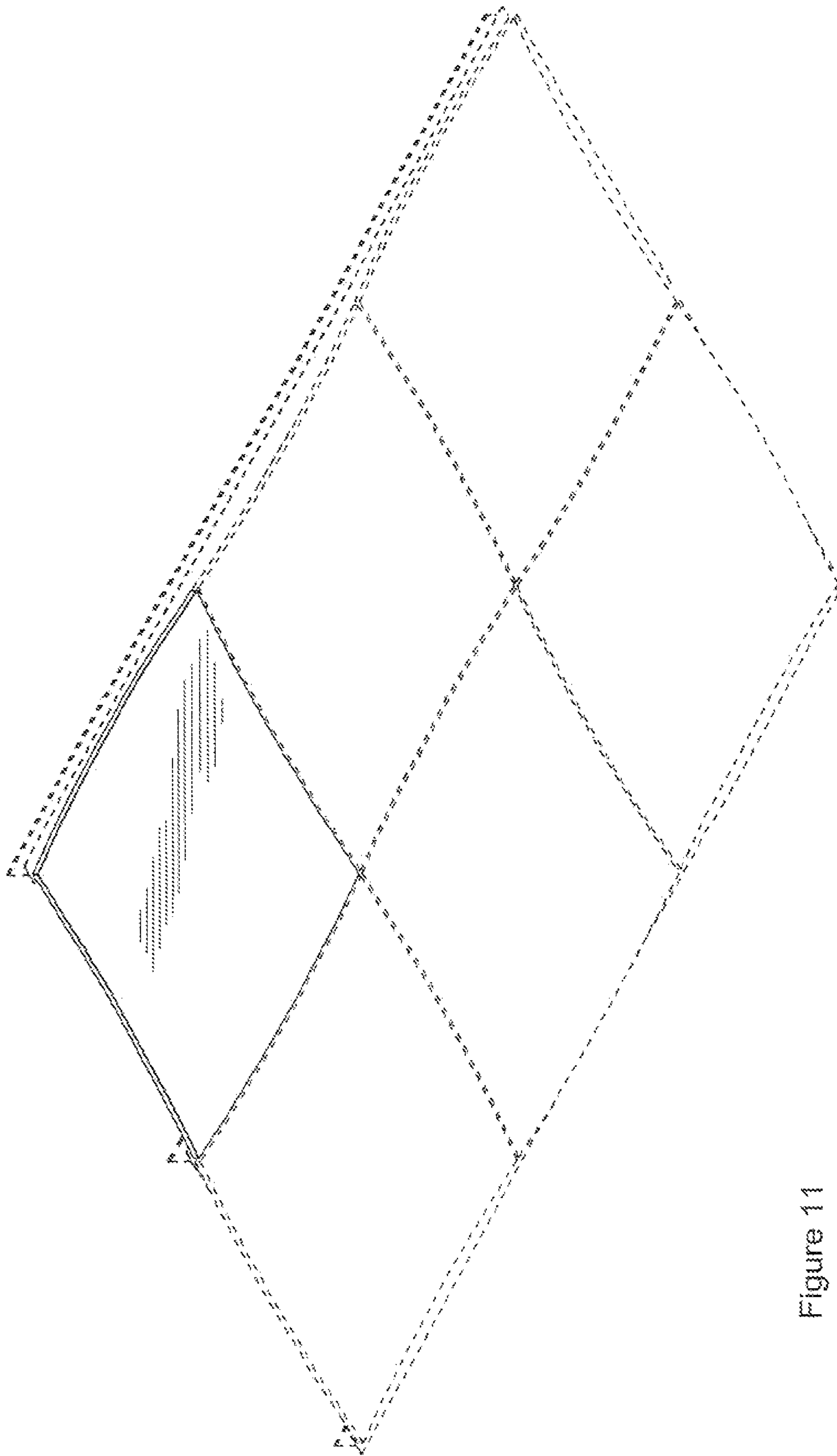
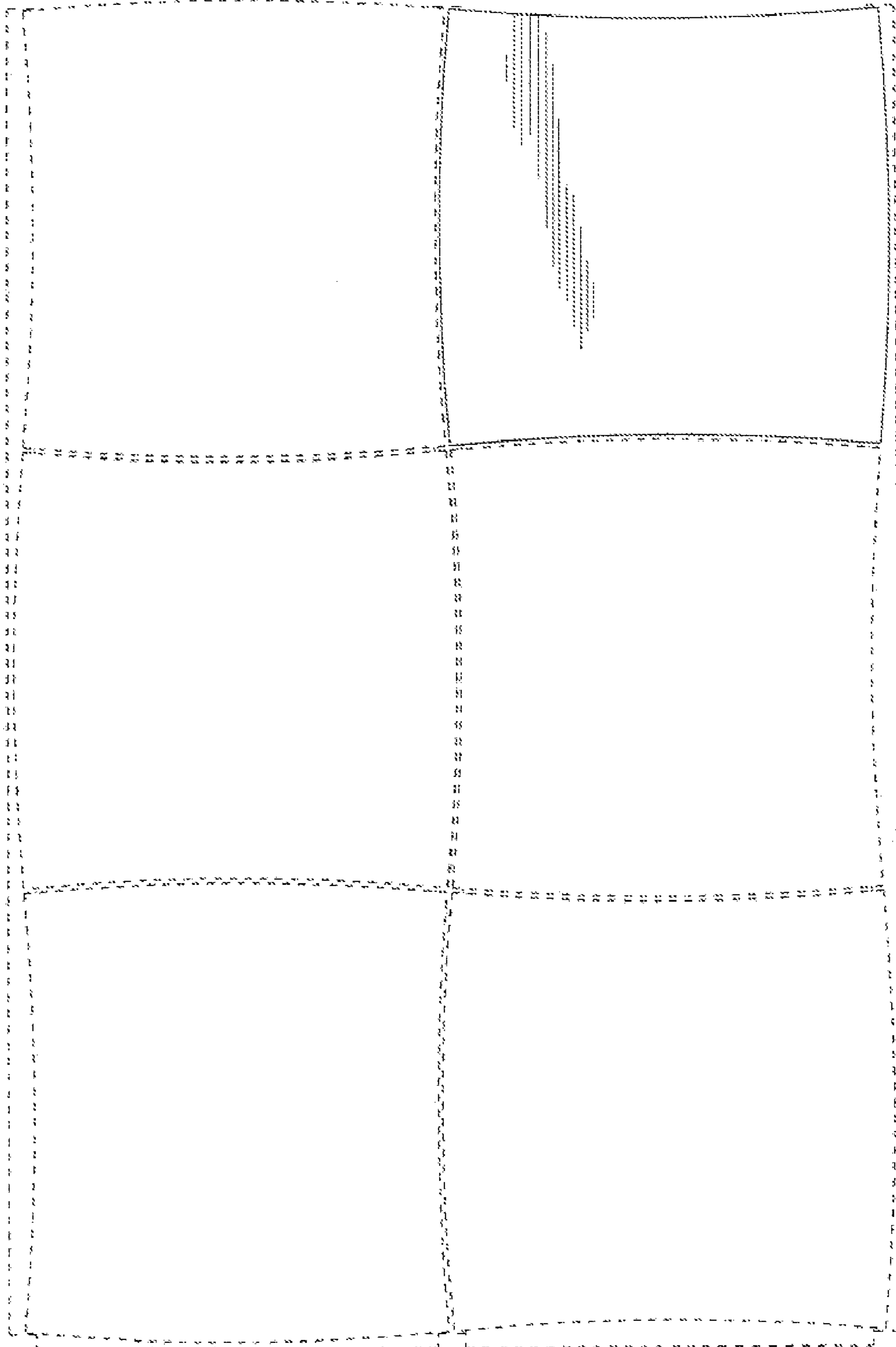

Figure 11

Figure 12



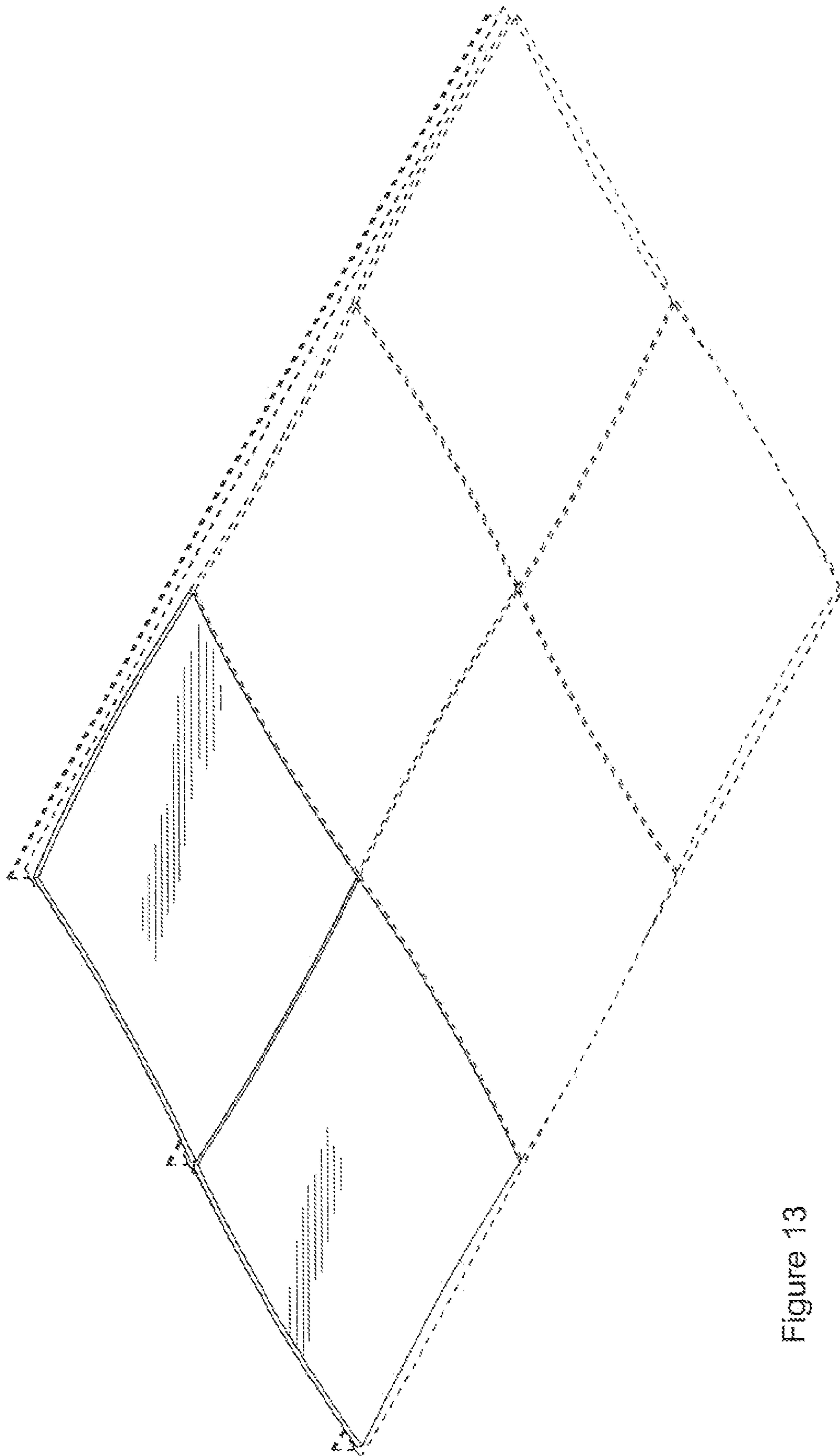
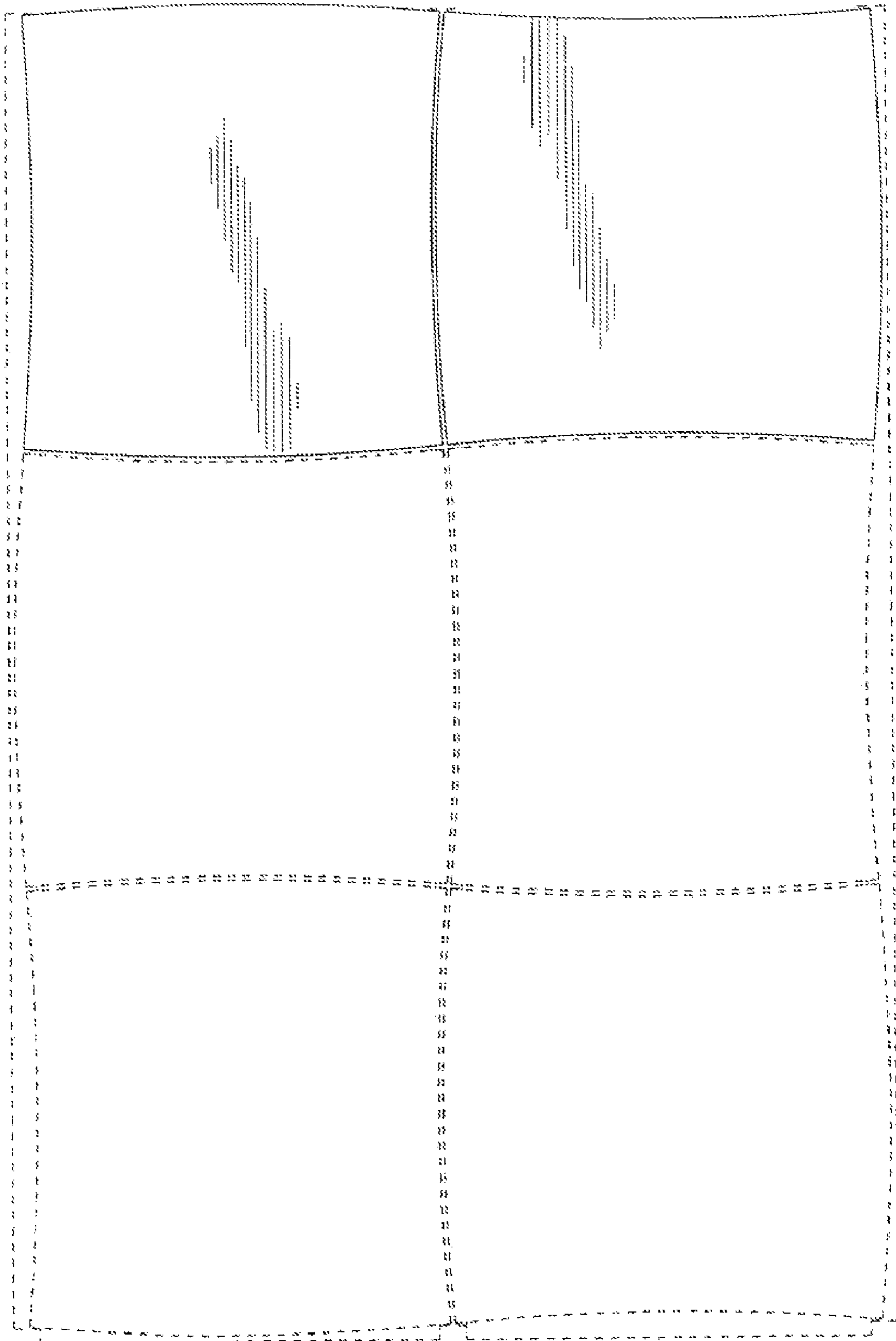

Figure 13

Figure 14



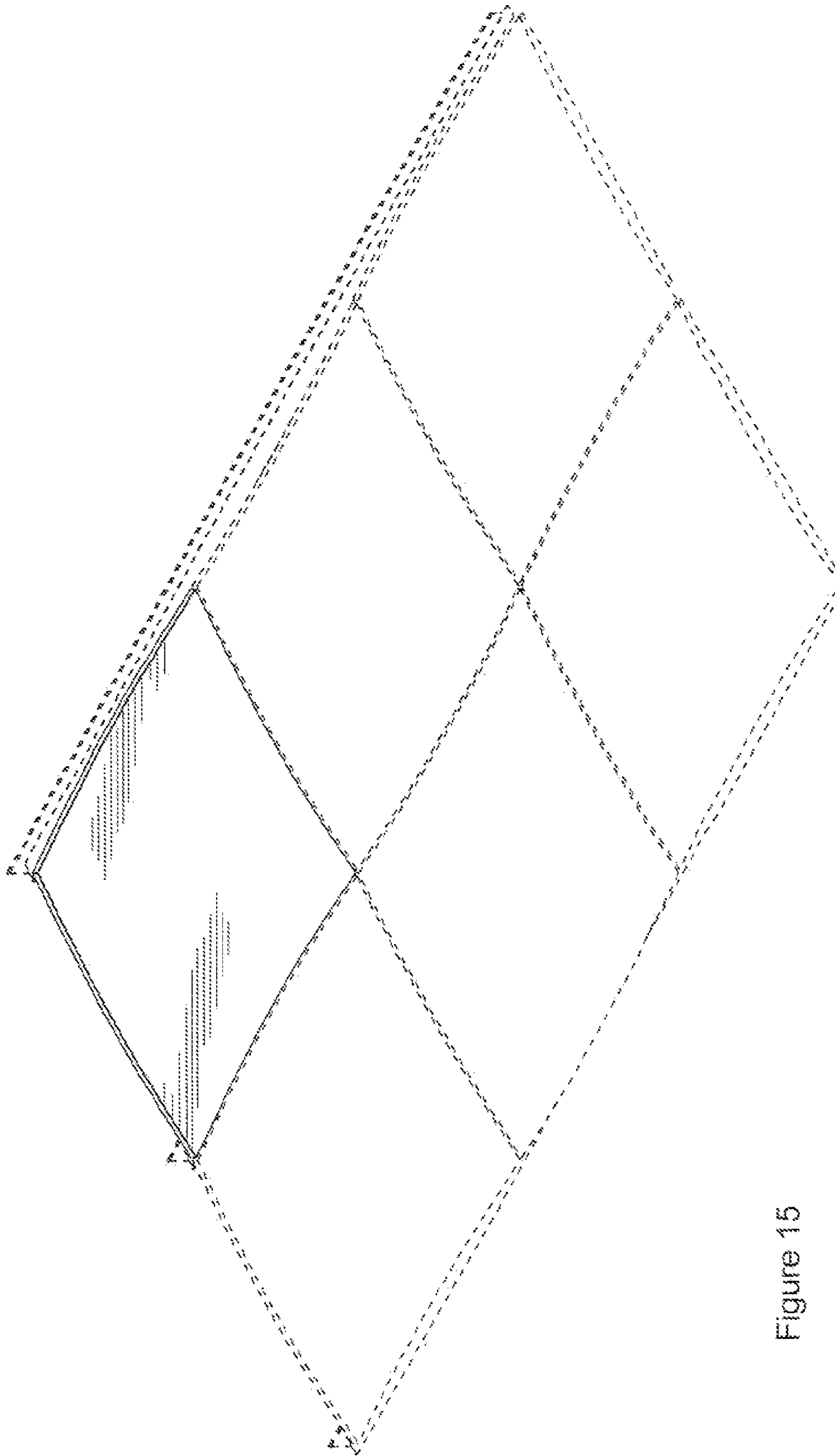

Figure 15



Figure 16

