



US00D605696S

(12) **United States Design Patent**
Ma

(10) **Patent No.:** **US D605,696 S**
(45) **Date of Patent:** **** Dec. 8, 2009**

(54) **HIGHLIGHTER**

(75) Inventor: **Qiankun Ma**, Ningbo (CN)

(73) Assignee: **Beifa Group Co., Ltd.**, Ningbo (CN)

(**) Term: **14 Years**

(21) Appl. No.: **29/319,439**

(22) Filed: **Jun. 9, 2008**

(30) **Foreign Application Priority Data**

Dec. 7, 2007 (CN) 2007 3 0281997

(51) **LOC (9) Cl.** **19-06**

(52) **U.S. Cl.** **D19/43**

(58) **Field of Classification Search** D7/642,
D7/643, 644; D19/35, 36, 41, 42, 43, 44,
D19/45, 46, 47, 48, 49, 50, 51, 54, 55, 56,
D19/57; D26/37, 51; D27/146; 24/11 F,
24/11 P, 11 R; 401/6, 52, 99, 100, 104, 105,
401/106, 107, 108, 109, 192, 195; 708/107

See application file for complete search history.

(56) **References Cited**

U.S. PATENT DOCUMENTS

D89,846 S *	5/1933	Anderson	D19/48
2,555,985 A *	6/1951	Merryman	24/11 F
D201,412 S *	6/1965	DeGroft	D19/43
D220,295 S	3/1971	Anderson		
3,776,673 A *	12/1973	DeGroft	425/125
4,872,777 A *	10/1989	Dalbke	401/199
D441,791 S *	5/2001	Kimura et al.	D19/43
D442,225 S *	5/2001	Lewis, Jr.	D19/47
D457,186 S *	5/2002	Moon	D19/43
D476,364 S	6/2003	Bain		
D476,685 S	7/2003	Metaxatos		

(Continued)

Primary Examiner—Caron Veynar

Assistant Examiner—Karen E Eldridge Powers

(74) *Attorney, Agent, or Firm*—Christensen O'Connor Johnson Kindness PLLC

(57) **CLAIM**

The ornamental design for a highlighter, as shown and described.

DESCRIPTION

FIG. 1 is an upper front right perspective view of a highlighter showing my new design;

FIG. 2 is an exploded lower front right perspective view thereof;

FIG. 3 is a right side elevation view thereof;

FIG. 4 is a bottom plan view thereof;

FIG. 5 is a front elevation view thereof;

FIG. 6 is a left side elevation view thereof;

FIG. 7 is a top plan view thereof;

FIG. 8 is a rear elevation view thereof;

FIG. 9 is an upper front right perspective view of the highlighter shown in FIG. 1, with the cap not shown for convenience of illustration;

FIG. 10 is a right side elevation view thereof;

FIG. 11 is a bottom plan view thereof;

FIG. 12 is a front elevation view thereof;

FIG. 13 is a left side elevation view thereof;

FIG. 14 is a top plan view thereof;

FIG. 15 is a rear elevation view thereof;

FIG. 16 is an upper front perspective view of the cap of the highlighter shown in FIG. 1, with the highlighter not shown for convenience of illustration;

FIG. 17 is a right side elevation view thereof;

FIG. 18 is a front elevation view thereof;

FIG. 19 is a left side elevation view thereof;

FIG. 20 is a rear elevation view thereof;

FIG. 21 is a bottom plan view thereof; and,

FIG. 22 is a top plan view thereof.

1 Claim, 8 Drawing Sheets

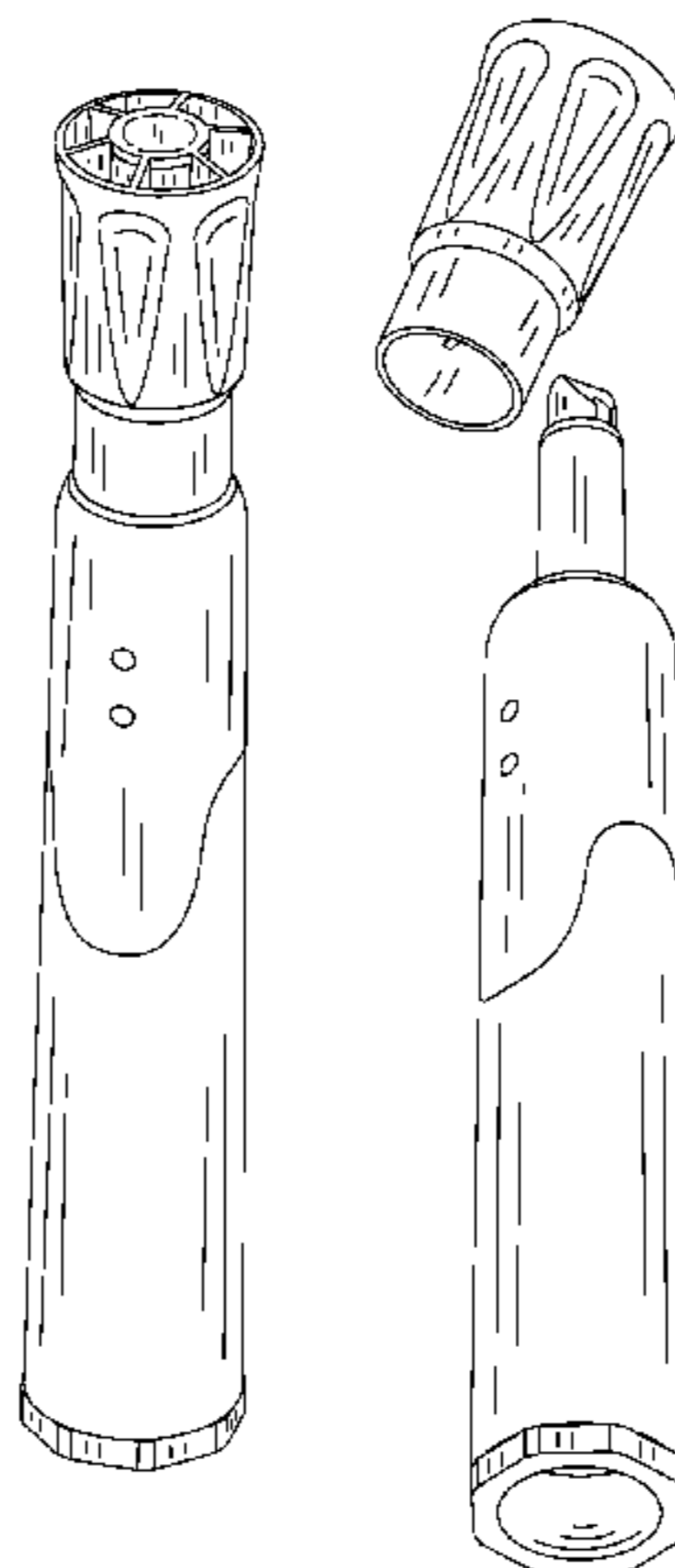

US D605,696 S

Page 2

U.S. PATENT DOCUMENTS

D493,832 S *	8/2004	Hung	D19/43	D557,744 S *	12/2007	Lecce	D19/51
D502,739 S *	3/2005	Shova et al.	D19/66	D569,428 S *	5/2008	Qiu	D19/43
D508,079 S *	8/2005	Qiu	D19/43	D572,753 S *	7/2008	Brigham et al.	D19/41
D534,211 S	12/2006	Kent			D573,183 S *	7/2008	Qiu et al.	D19/36
D535,330 S *	1/2007	Hung	D19/43	D581,461 S *	11/2008	Li	D19/48
					D589,088 S *	3/2009	Li	D19/50

* cited by examiner

Fig.1.

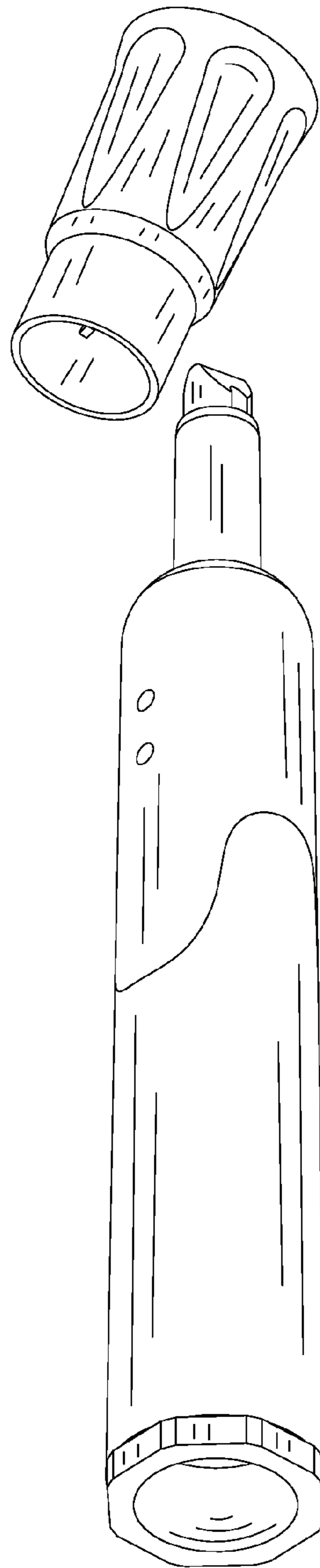
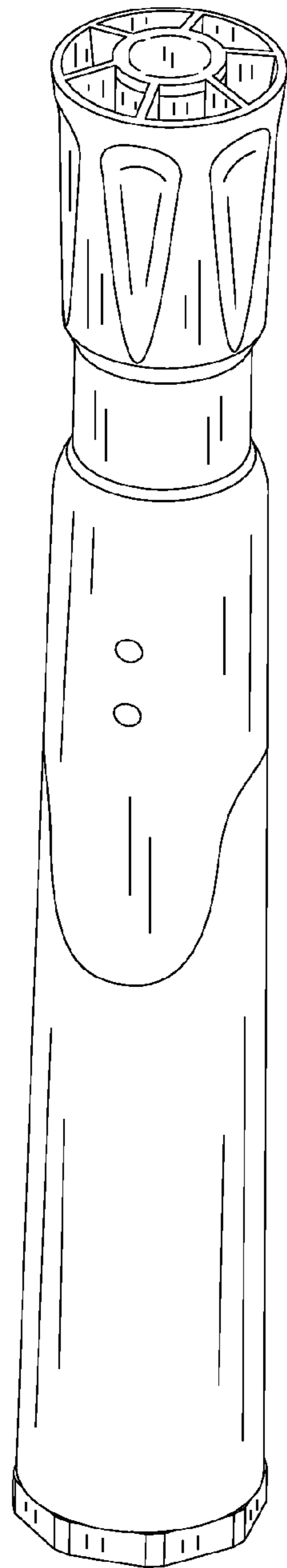

Fig.2.

Fig.3.

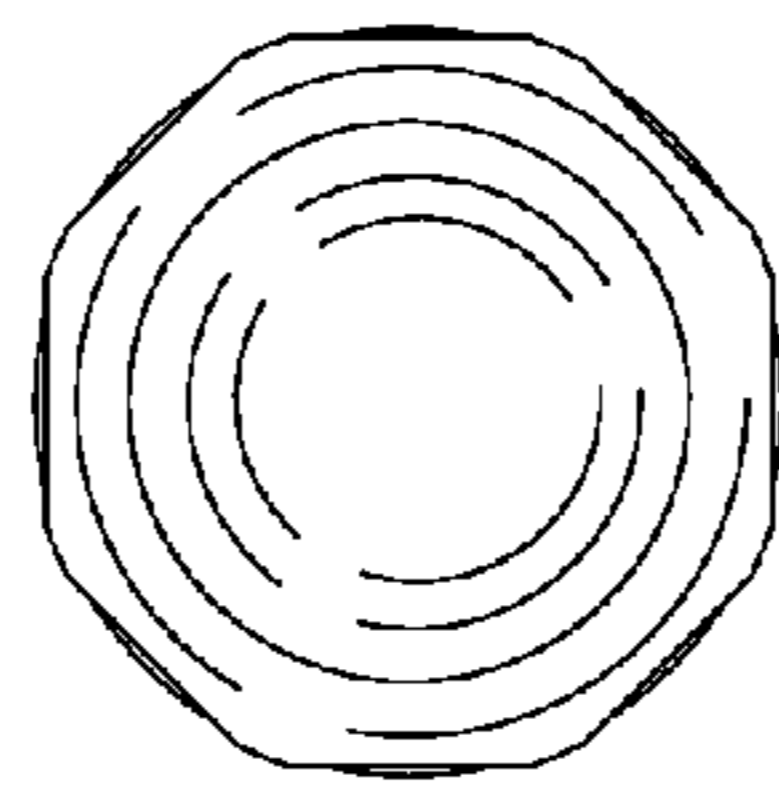
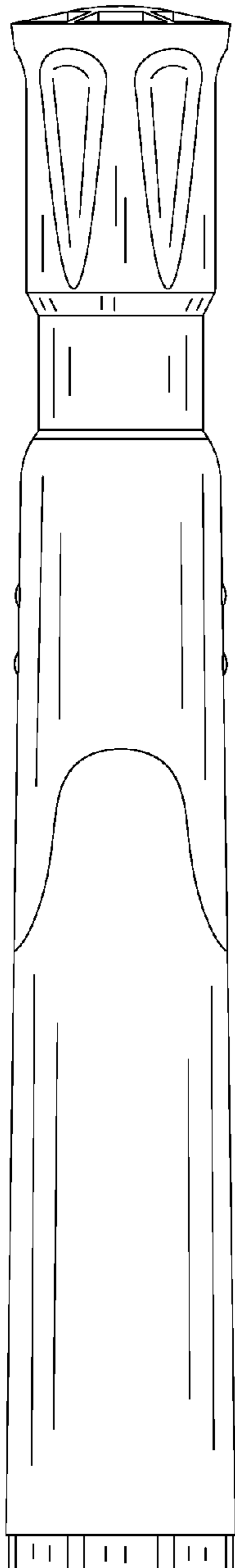

Fig.4.

Fig.5.

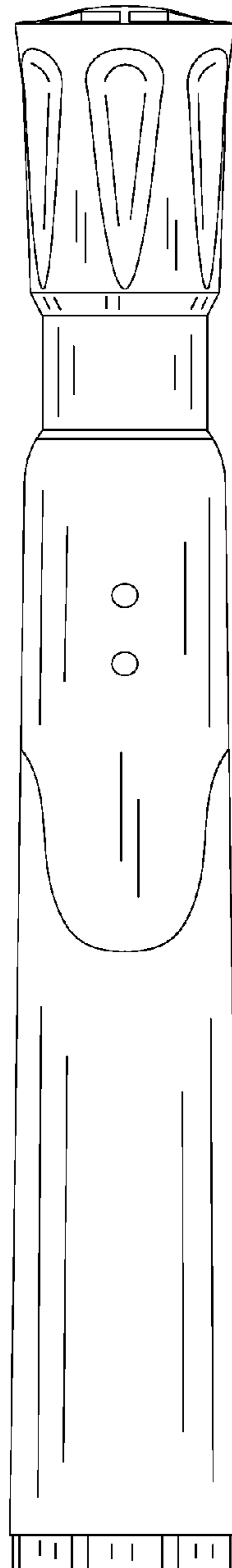

Fig. 6.

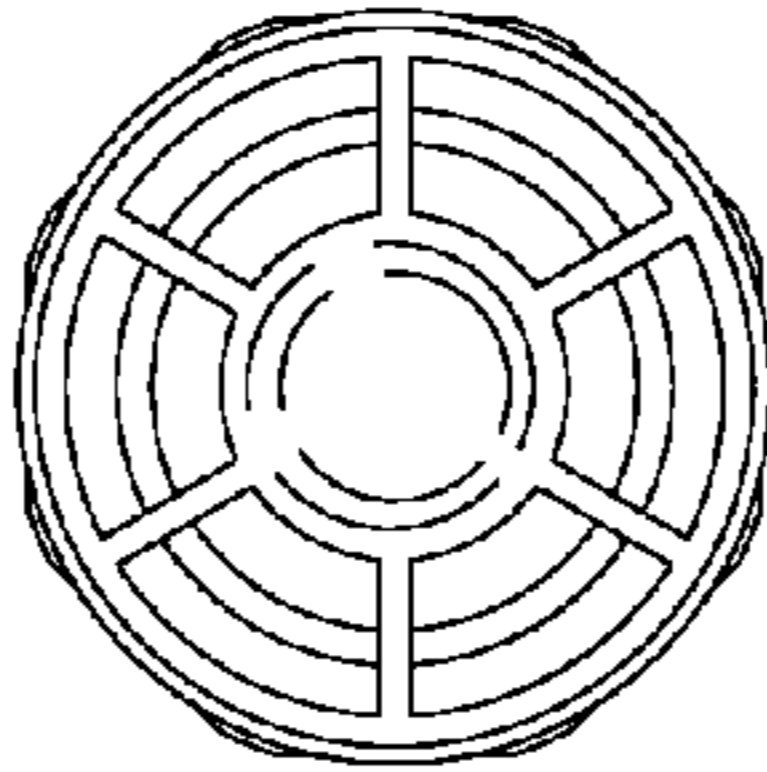
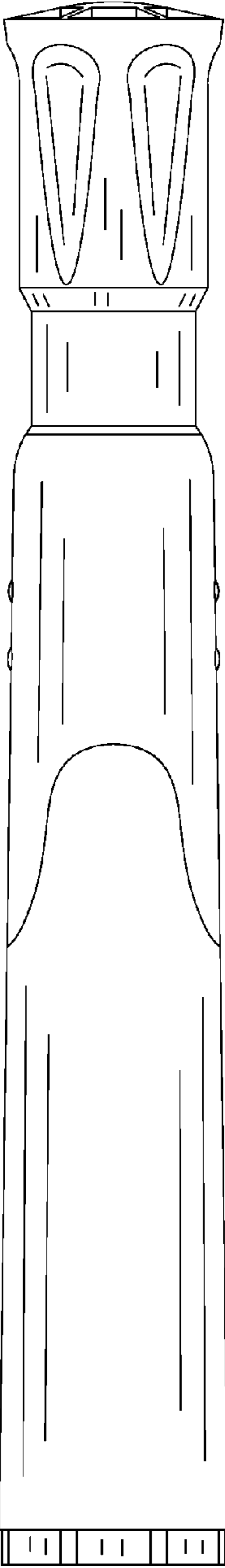

Fig. 7.

Fig. 8.

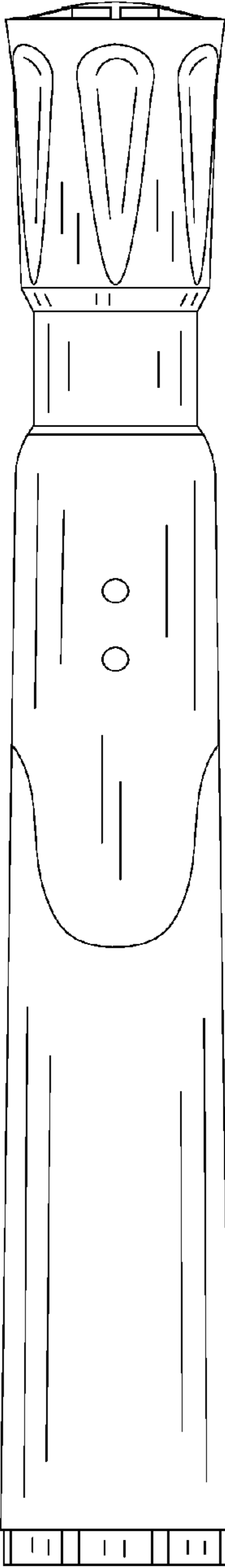
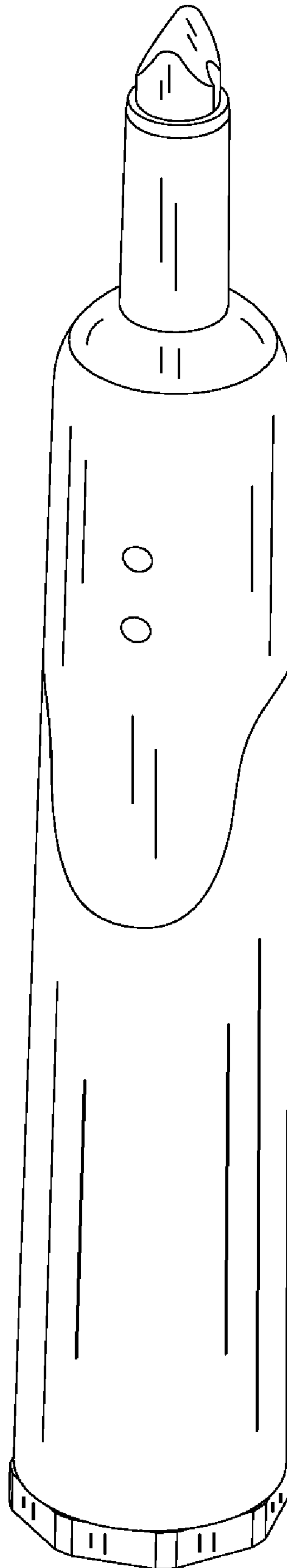
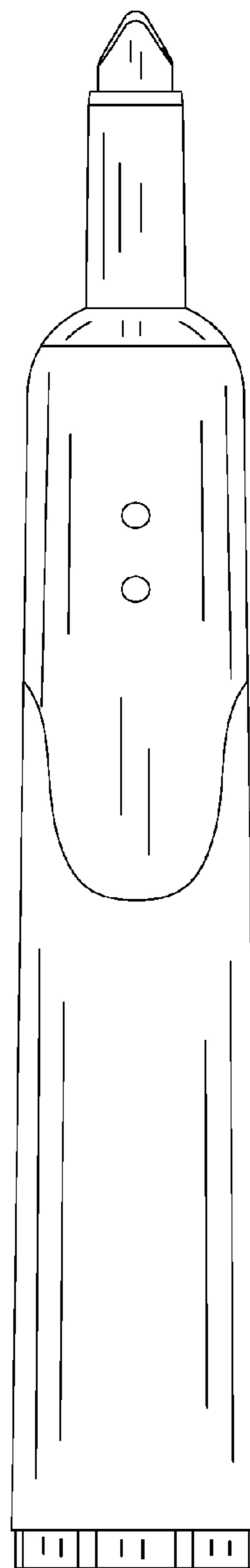
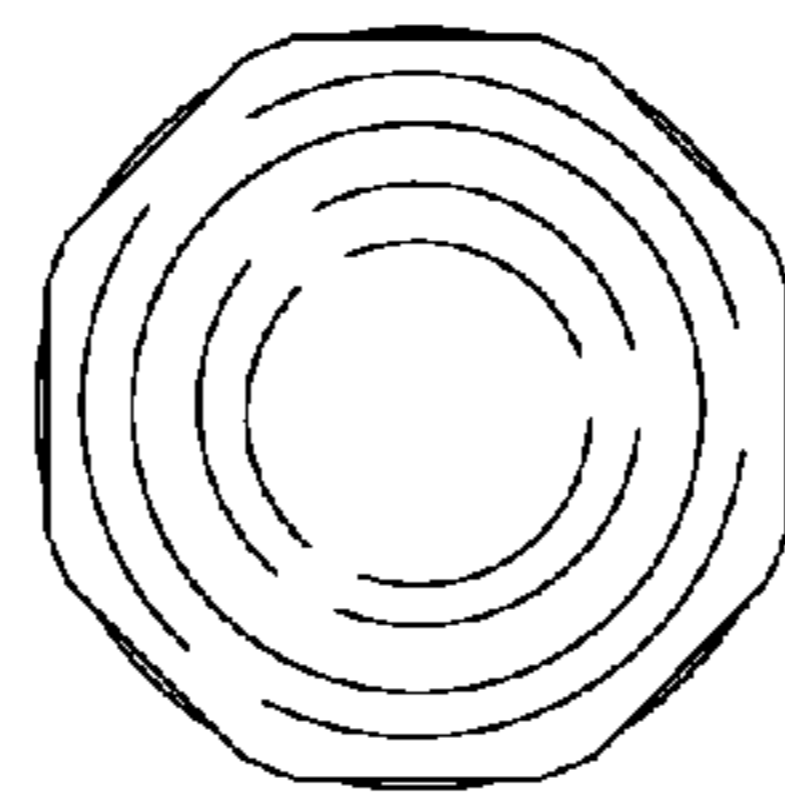
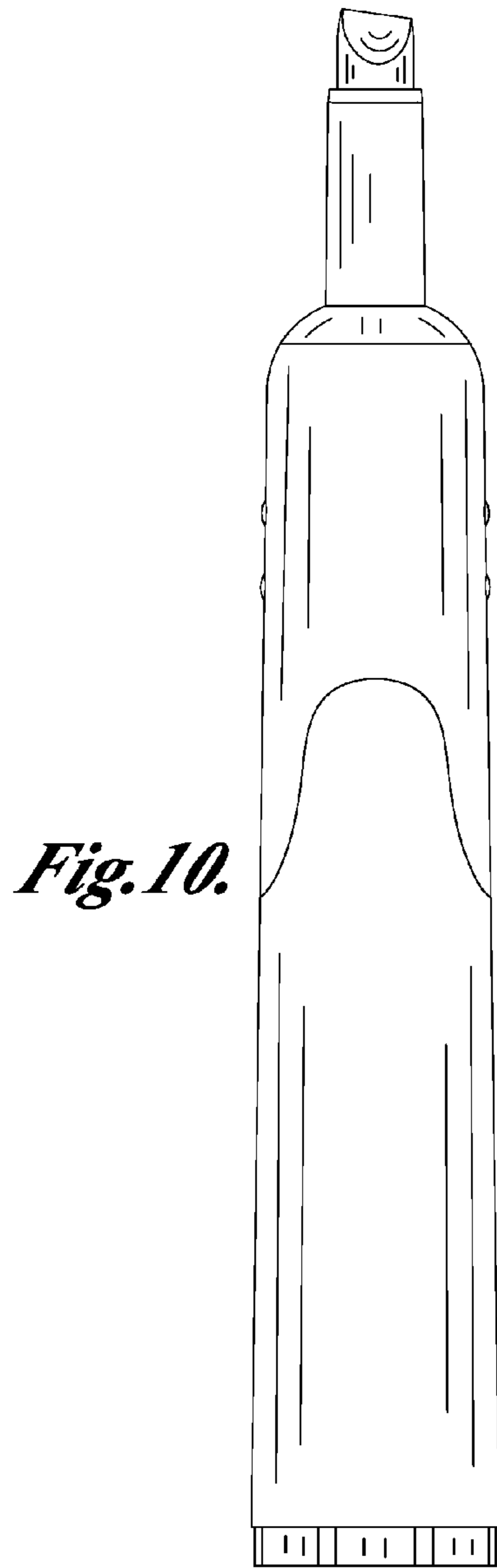
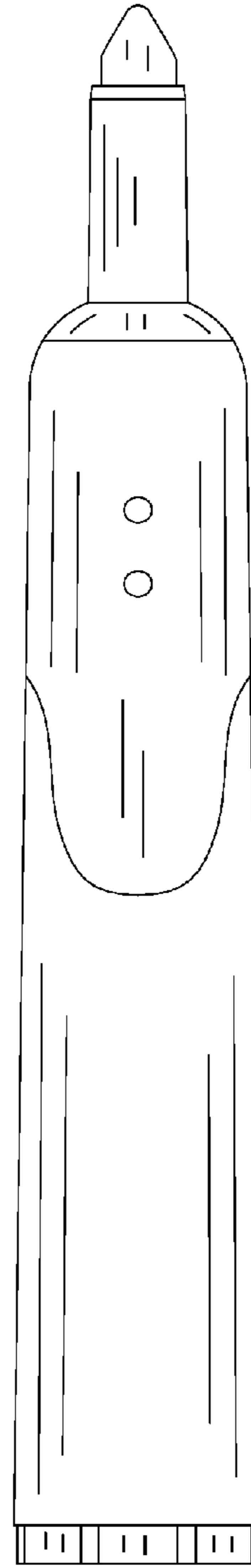
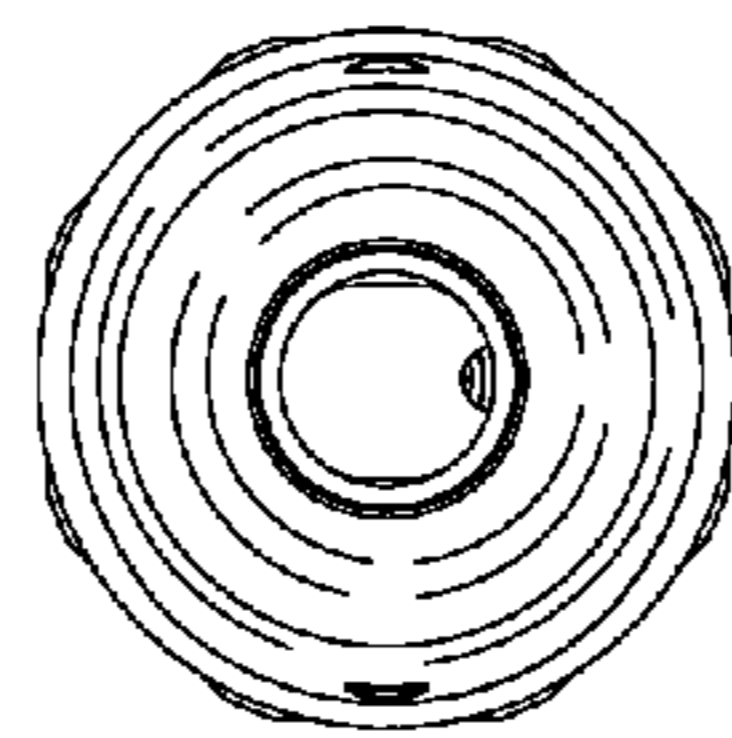
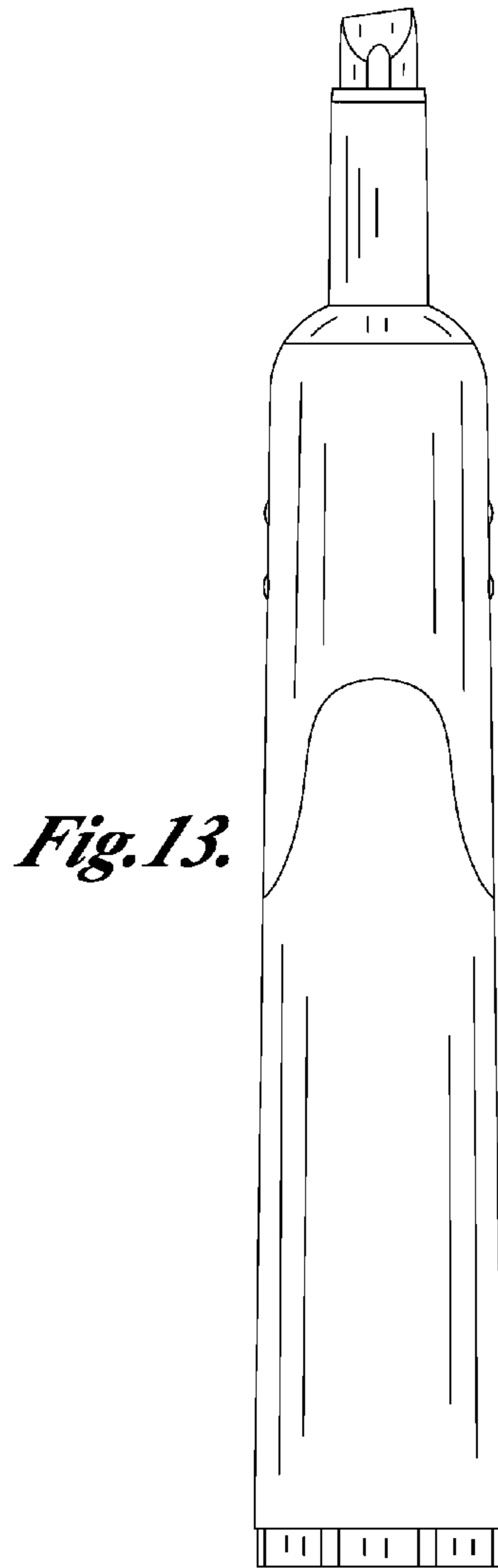

Fig. 9.







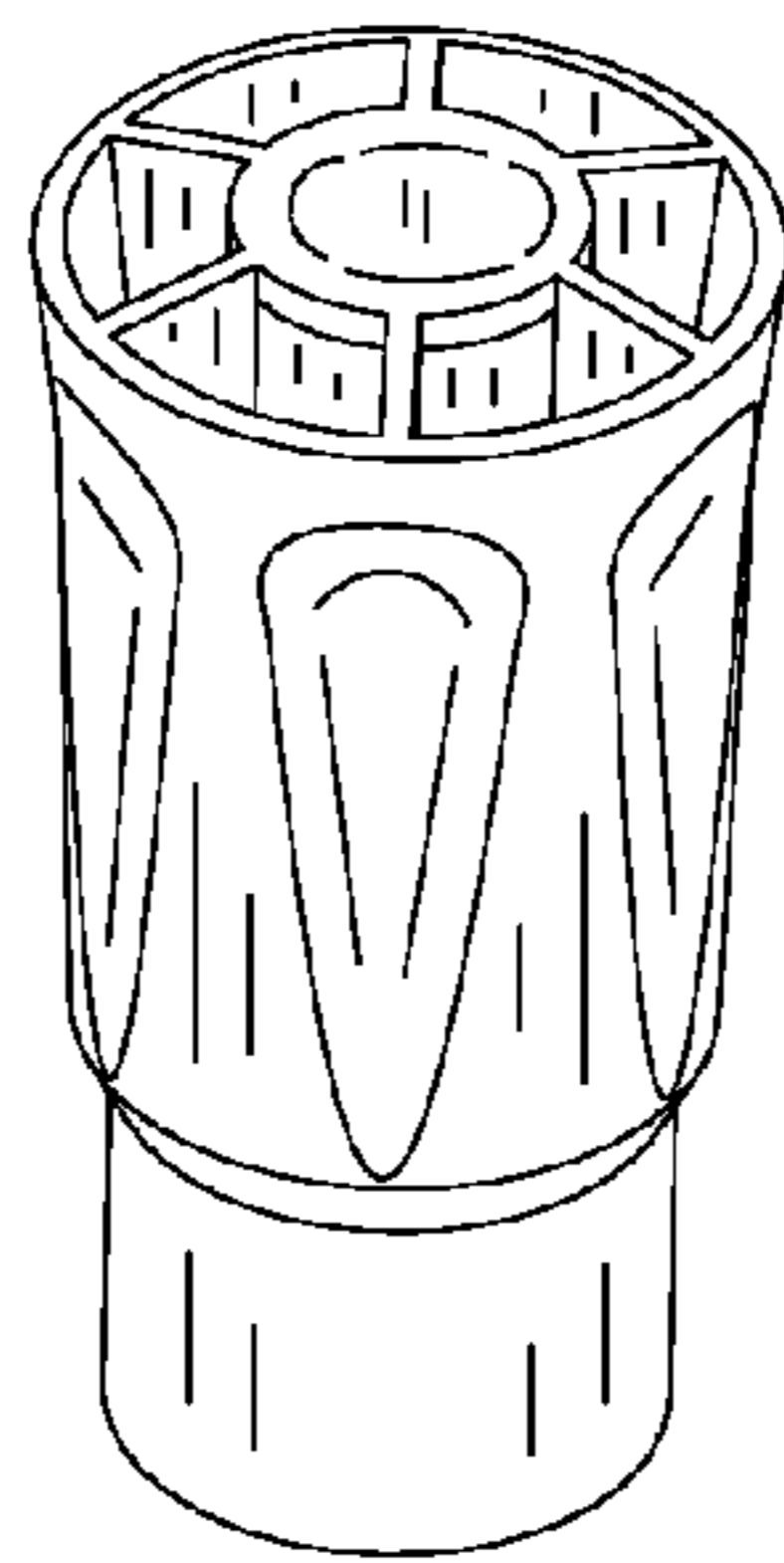

Fig. 16.

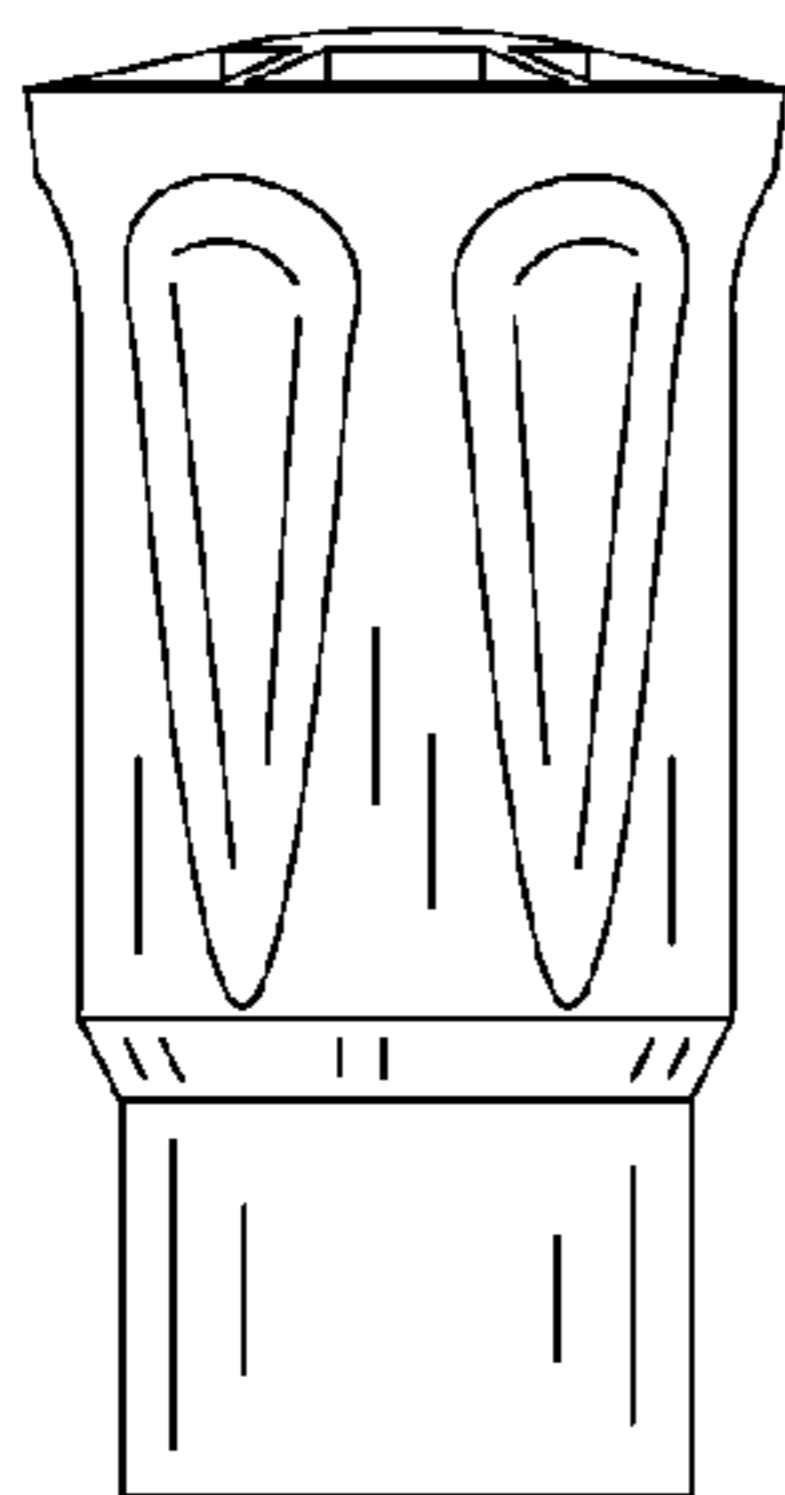

Fig. 17.

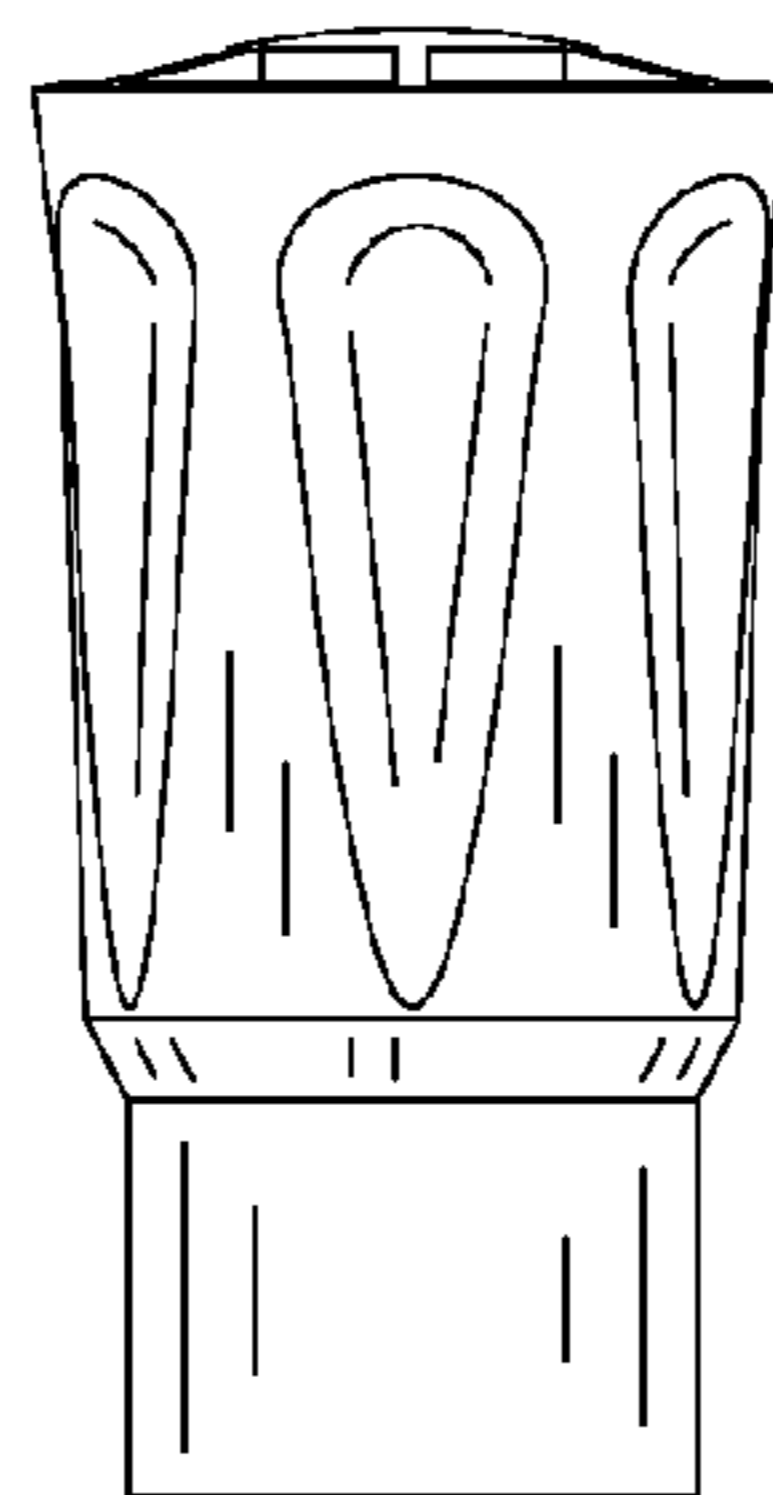

Fig. 18.

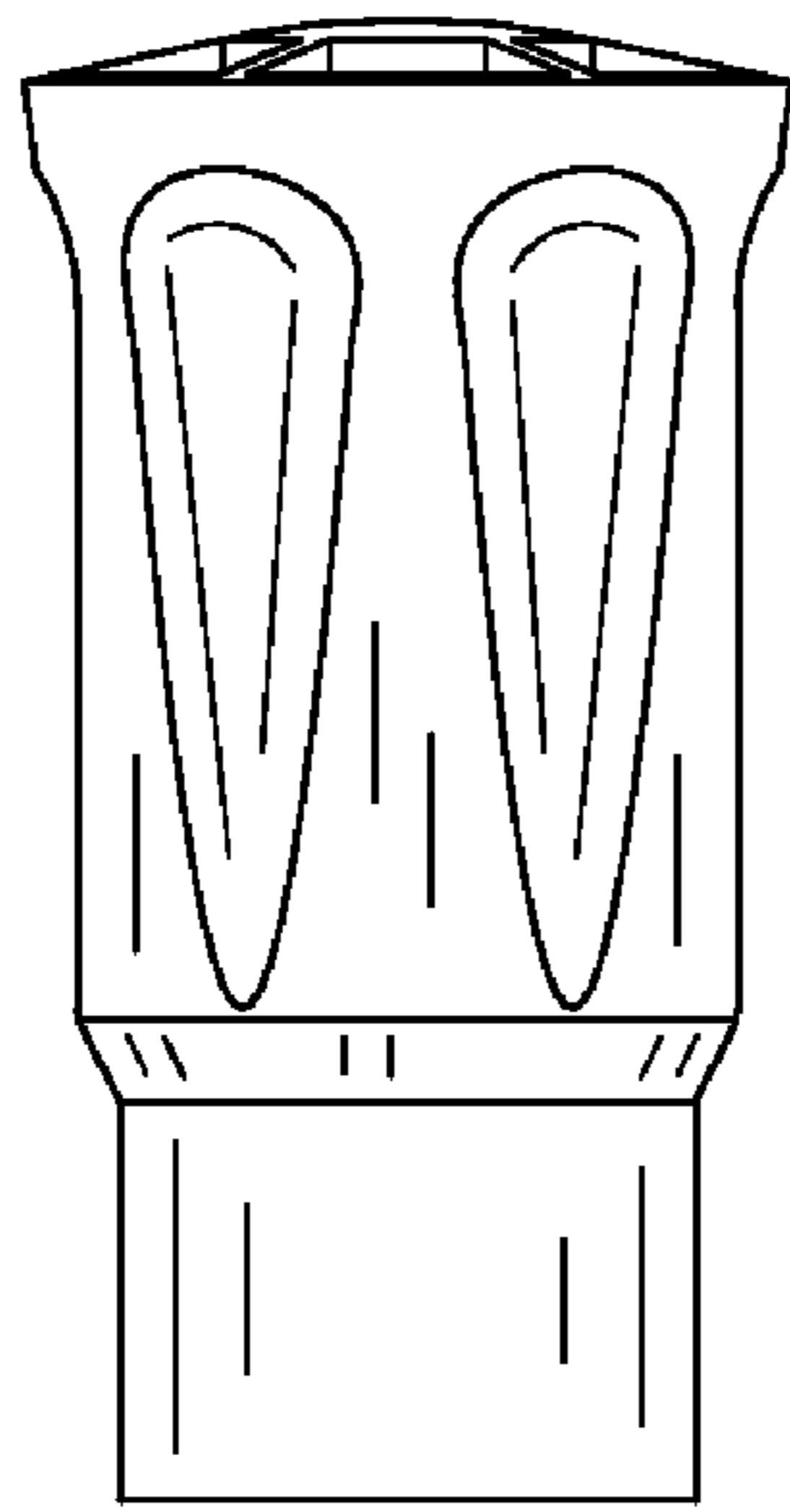

Fig. 19.

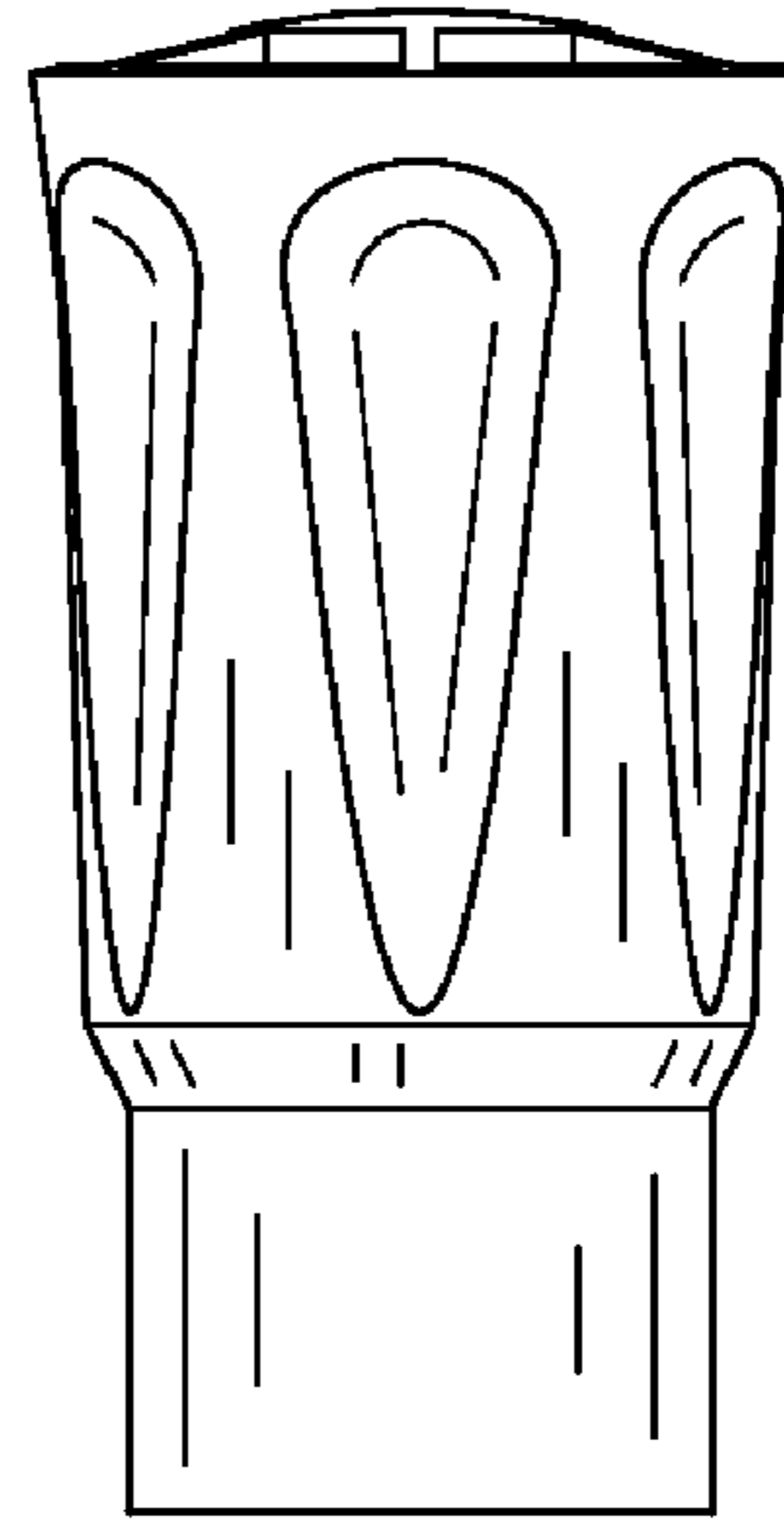

Fig. 20.

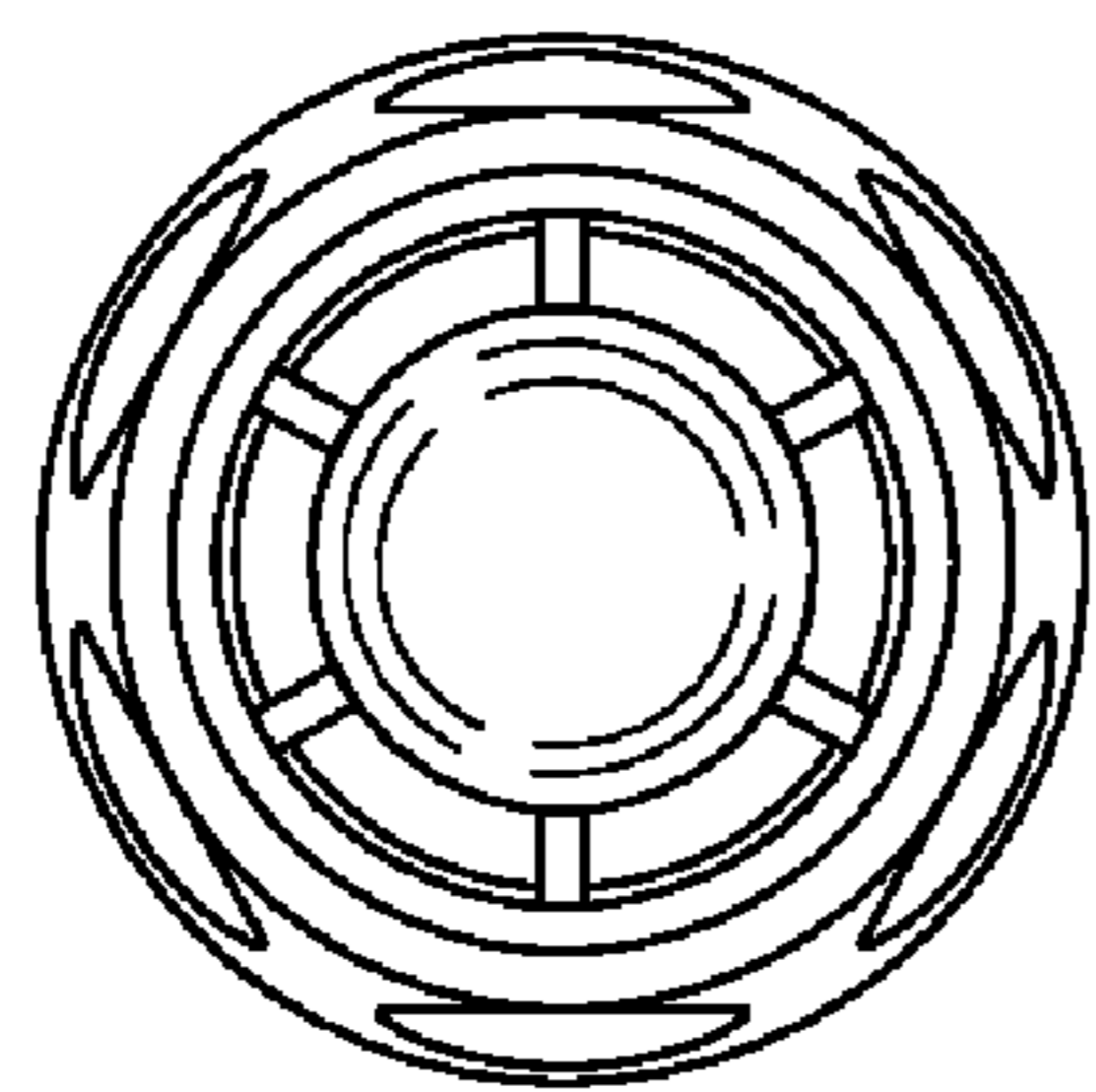

Fig. 21.

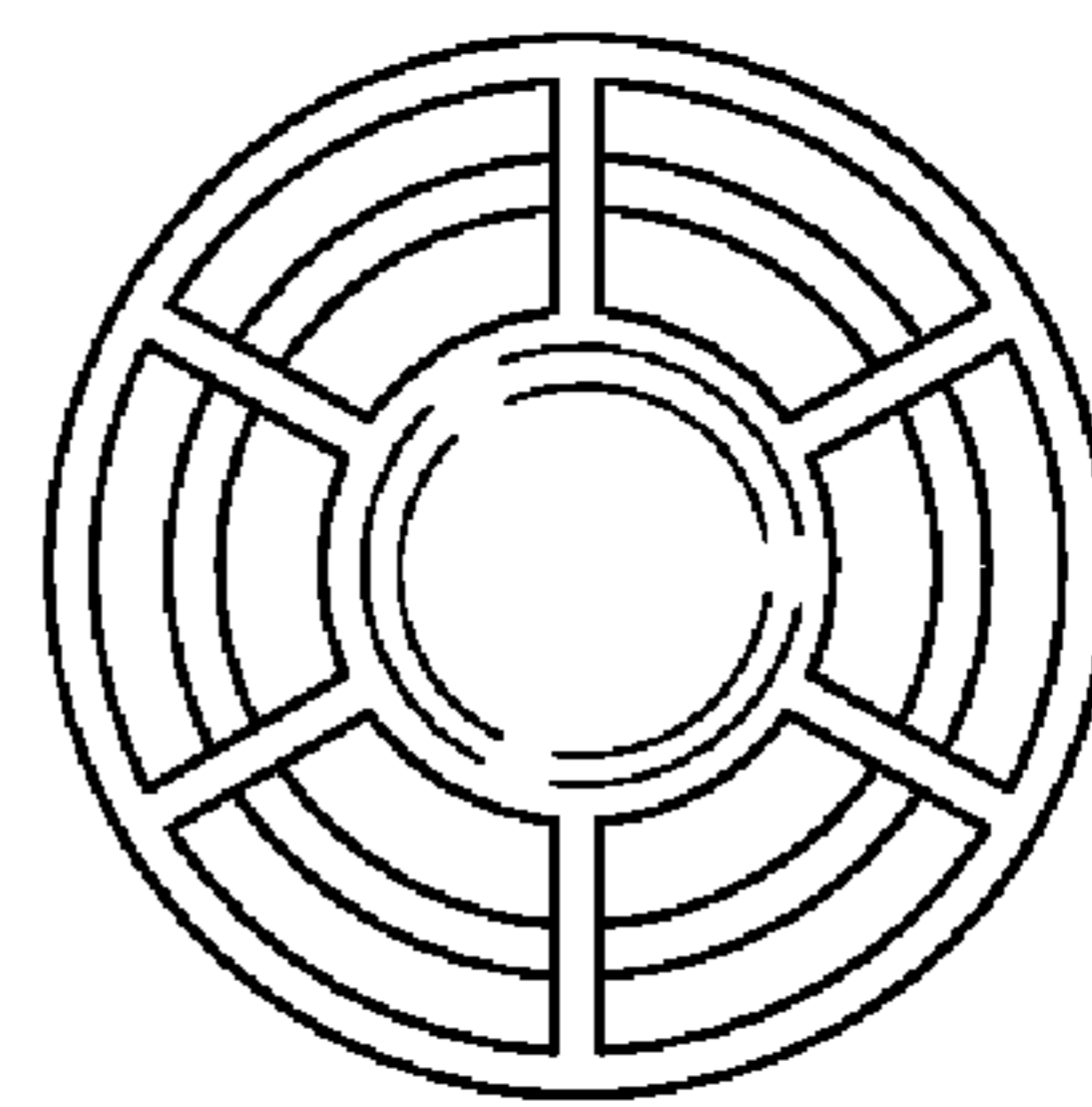

Fig. 22.