



US00D605672S

(12) **United States Design Patent**
Allen et al.

(10) **Patent No.:** **US D605,672 S**
(45) **Date of Patent:** **** Dec. 8, 2009**

(54) **CUTTING BLADE**

4,244,667 A 1/1981 Timmons

(75) Inventors: **Douglas Allen**, Pewaukee, WI (US);
Richard Hohnl, Jr., Racine, WI (US)

(Continued)

(73) Assignee: **Milwaukee Electric Tool Corporation**,
Brookfield, WI (US)

FOREIGN PATENT DOCUMENTS

(**) Term: **14 Years**

CA	2097971	12/1994
CA	2313749	9/2001
DE	282475	8/1913
EP	0870561	10/1998
GB	674018	6/1952
GB	791571	3/1958
JP	11-179720	7/1999

(21) Appl. No.: **29/277,563**

(22) Filed: **Mar. 1, 2007**

(51) **LOC (9) Cl.** **15-09**

Primary Examiner—Sandra Snapp

(52) **U.S. Cl.** **D15/139**

Assistant Examiner—Patricia Palasik

(58) **Field of Classification Search** D8/7,
D8/8, 70; D15/127, 138, 139; 29/239, 252;
30/134, 180, 228; 81/186, 302, 349; 175/420.1,
175/420.2, 426-435; 407/107-119

(74) *Attorney, Agent, or Firm*—Michael Best & Friedrich
LLP

See application file for complete search history.

(57) **CLAIM**

(56) **References Cited**

I claim the ornamental design for a cutting blade, as shown
and described.

U.S. PATENT DOCUMENTS

DESCRIPTION

371,954 A	10/1887	Larger	
632,560 A	9/1899	Furbish	
1,787,229 A	12/1930	Zimmermann	
2,172,070 A	9/1939	Palmgren	
2,179,070 A	11/1939	Weise	
2,577,987 A	12/1951	Wilson	
2,593,823 A	4/1952	Wilson	
2,779,361 A	1/1957	McKiff	
2,794,469 A	6/1957	Shortell	
3,165,131 A	1/1965	Mackay	
3,262,474 A	7/1966	Enders	
3,390,596 A	7/1968	Trevathan	
3,609,056 A	9/1971	Hougen	
3,610,768 A	10/1971	Cochran	
3,648,508 A	3/1972	Hougen	
3,687,565 A	8/1972	Byers et al.	
3,945,753 A	3/1976	Byers et al.	
D239,519 S *	4/1976	Townsend	D15/139
4,090,807 A	5/1978	Stewart	
4,239,427 A	12/1980	Walton, II	

FIG. 1 is a front perspective view of a cutting blade with the
cutting edge shown broken away to indicate indeterminate
length.

FIG. 2 is a front view of the cutting blade shown in FIG. 1.

FIG. 3 is a top view of the cutting blade shown in FIG. 1.

FIG. 4 is a bottom view of the cutting blade shown in FIG. 1.

FIG. 5 is a rear view of the cutting blade shown in FIG. 1.

FIG. 6 is a right side view of the cutting blade shown in FIG.
1; and,

FIG. 7 is a left side view of the cutting blade shown in FIG. 1.

The present application is directed to independent features of
the shape and contour of the design illustrated in the draw-
ings. The broken line showing of the cutting tool is included
for the purpose of illustrating portions of the cutting tool and
forms no part of the claimed design.

1 Claim, 5 Drawing Sheets

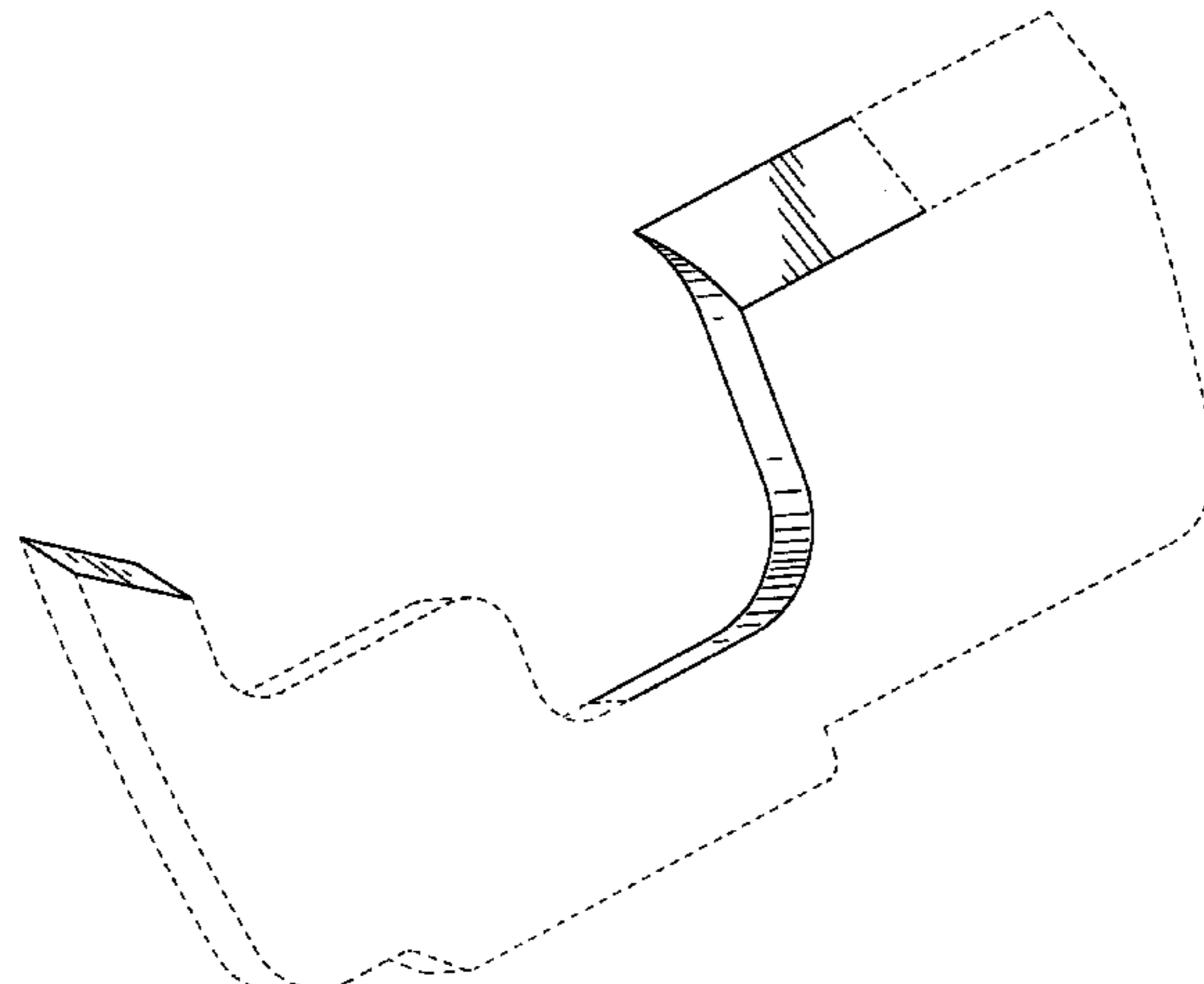

US D605,672 S

Page 2

U.S. PATENT DOCUMENTS						
			6,457,916 B2	10/2002	Wienhold	
			6,488,452 B1	12/2002	Hoskins et al.	
4,367,991 A	1/1983	Grafe et al.	6,511,268 B1	1/2003	Vasudeva et al.	
4,406,334 A	9/1983	Baumann et al.	6,543,789 B2	4/2003	Frenzel et al.	
4,419,032 A	12/1983	Flowers	6,543,959 B1	4/2003	Jore	
4,536,107 A	8/1985	Sandy et al.	6,561,523 B1	5/2003	Wienhold	
4,589,807 A	5/1986	Martin	6,568,876 B2	5/2003	Augustin	
4,625,593 A	12/1986	Schmotzer	6,599,063 B1	7/2003	Capstran	
4,752,161 A	6/1988	Hill	6,612,788 B2	9/2003	Thomas et al.	
4,768,901 A	9/1988	Reinauer et al.	6,652,202 B2	11/2003	Remke et al.	
D298,633 S *	11/1988	Kenemore D15/139	6,659,473 B2	12/2003	Below et al.	
4,841,824 A *	6/1989	Hartmann et al. 83/830	6,695,321 B2	2/2004	Bedi et al.	
4,900,202 A	2/1990	Wienhold	6,702,529 B1 *	3/2004	Tagtstrom et al. 407/110	
4,968,193 A	11/1990	Chaconas et al.	6,705,807 B1	3/2004	Rudolph et al.	
5,011,344 A	4/1991	Johnson	6,722,667 B2	4/2004	Cantlon	
5,013,194 A	5/1991	Wienhold	6,817,429 B2 *	11/2004	Sollami 175/420.1	
5,193,951 A	3/1993	Schimke	6,874,978 B2	4/2005	Gongola	
D338,607 S *	8/1993	Anderson D8/98	6,929,434 B2	8/2005	Prokop	
5,288,183 A	2/1994	Chaconas et al.	D509,519 S *	9/2005	Sollami D15/139	
D347,150 S *	5/1994	Falconbridge D8/8	6,959,631 B2	11/2005	Sako	
5,358,361 A	10/1994	Jurski	6,968,912 B2 *	11/2005	Sollami et al. 175/420.1	
5,423,640 A	6/1995	Lindblom et al.	D513,273 S *	12/2005	Sollami D15/139	
5,570,978 A	11/1996	Rees et al.	D515,115 S *	2/2006	Sollami D15/139	
5,586,847 A	12/1996	Mattern, Jr. et al.	D522,339 S *	6/2006	Kimura D8/70	
5,649,794 A	7/1997	Kress et al.	7,100,714 B1 *	9/2006	Sollami 175/427	
5,695,304 A	12/1997	Ebert	7,168,511 B2 *	1/2007	Woods et al. 175/420.1	
D392,297 S	3/1998	Brutscher	D551,269 S	9/2007	Burke, III	
5,803,677 A	9/1998	Brutscher et al.	7,331,096 B2 *	2/2008	Kugler et al. 407/109	
5,807,039 A	9/1998	Booher et al.	2001/0013430 A1 *	8/2001	Hauptmann et al. 175/420.1	
5,813,802 A	9/1998	Ajimi et al.	2001/0019687 A1	9/2001	Eberhard	
5,820,319 A	10/1998	Hull et al.	2002/0081165 A1 *	6/2002	Hecht 407/110	
5,829,540 A *	11/1998	Peay et al. 175/420.1	2002/0106254 A1	8/2002	Rudolph	
5,934,843 A *	8/1999	Brask et al. 407/106	2002/0141838 A1	10/2002	Thomas et al.	
D416,567 S *	11/1999	Vogelsanger D15/139	2003/0068208 A1	4/2003	Eberhard	
5,975,814 A	11/1999	Pomp	2003/0103822 A1	6/2003	Wirth et al.	
6,024,520 A	2/2000	Haughton et al.	2003/0230862 A1	12/2003	Peters et al.	
D422,459 S *	4/2000	Webb et al. D7/625	2004/0042861 A1	3/2004	Capstran	
6,045,302 A	4/2000	Orr	2004/0101376 A1	5/2004	Shemeta	
6,053,675 A	4/2000	Holland et al.	2004/0101379 A1	5/2004	Mabuchi et al.	
6,109,841 A	8/2000	Johne	2004/0175244 A1	9/2004	Otten	
6,179,718 B1	1/2001	Morath et al.	2004/0179912 A1	9/2004	Quanz	
D438,219 S	2/2001	Brutscher	2004/0265080 A1	12/2004	Danielsson et al.	
6,199,872 B1	3/2001	Hasan	2005/0025594 A1	2/2005	Lindblom	
6,261,033 B1	7/2001	Thames et al.	2005/0105981 A1	5/2005	Byrley et al.	
6,270,297 B1	8/2001	Fang et al.	2005/0135887 A1	6/2005	Borschert et al.	
6,302,408 B1	10/2001	Zierpka	2005/0249562 A1	11/2005	Frejd	
6,347,914 B1	2/2002	Boyle et al.	2005/0249563 A1	11/2005	Scott et al.	
6,354,177 B2	3/2002	Peters	2007/0172325 A1	7/2007	Ebert	
6,354,773 B1	3/2002	Konen	2007/0212179 A1	9/2007	Khangar et al.	
6,354,774 B1	3/2002	Haughton et al.	2007/0277656 A1 *	12/2007	Zeiler et al. 83/13	
6,394,714 B2	5/2002	Eberhard	2008/0008548 A1	1/2008	Corso et al.	
6,394,715 B1	5/2002	Boyle et al.				
D459,741 S *	7/2002	Erickson D15/139				

* cited by examiner

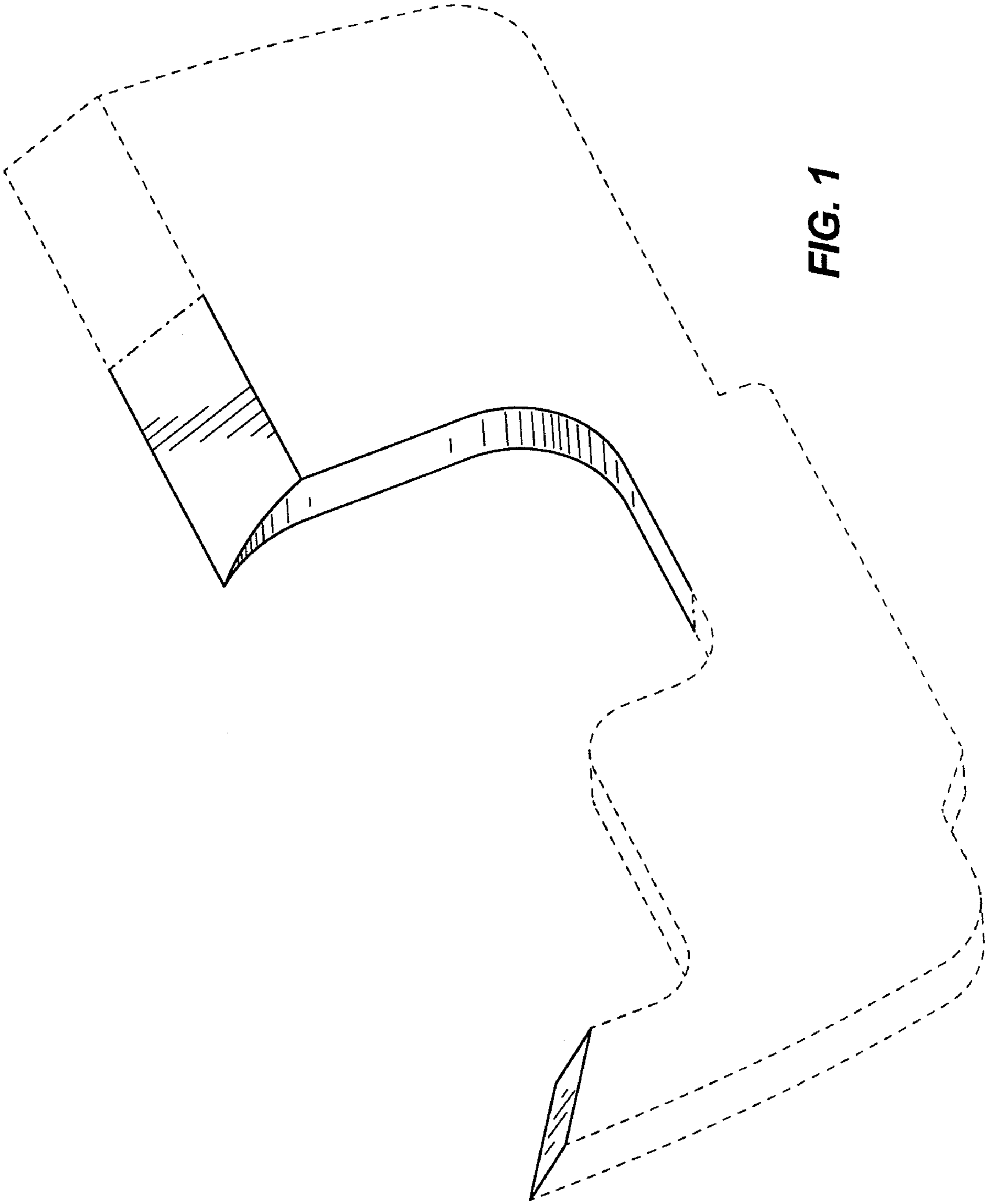

FIG. 1

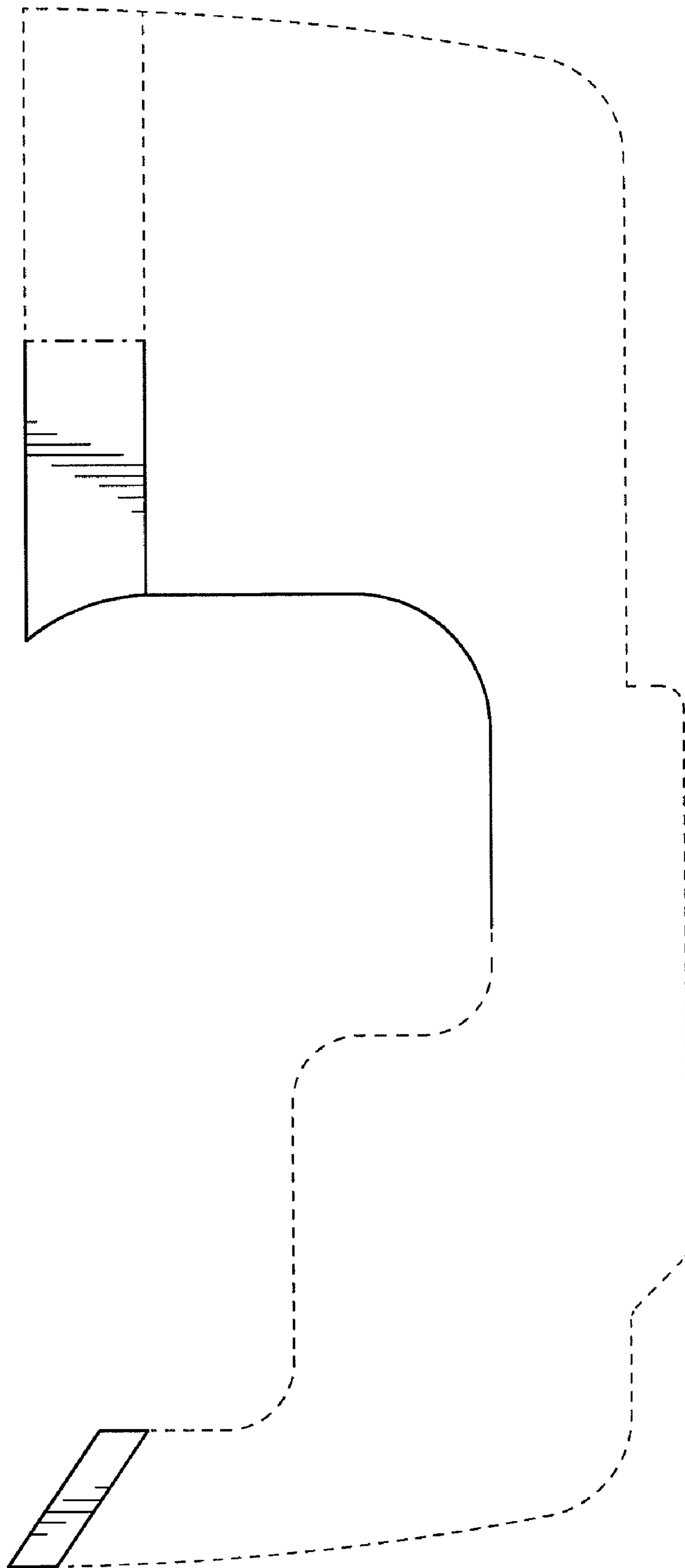

FIG. 2

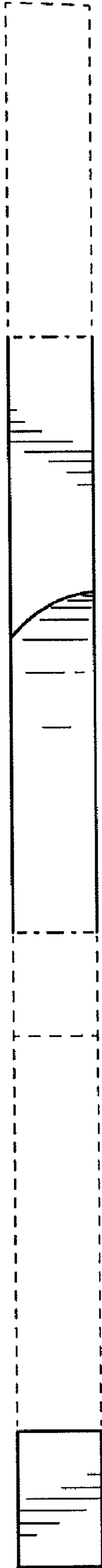

FIG. 3

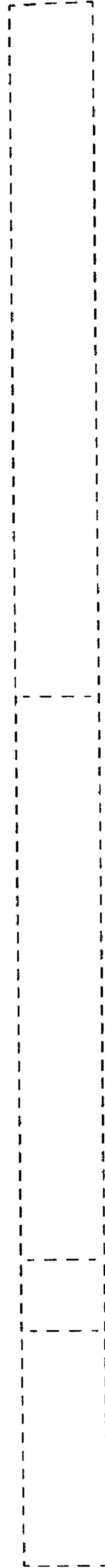

FIG. 4

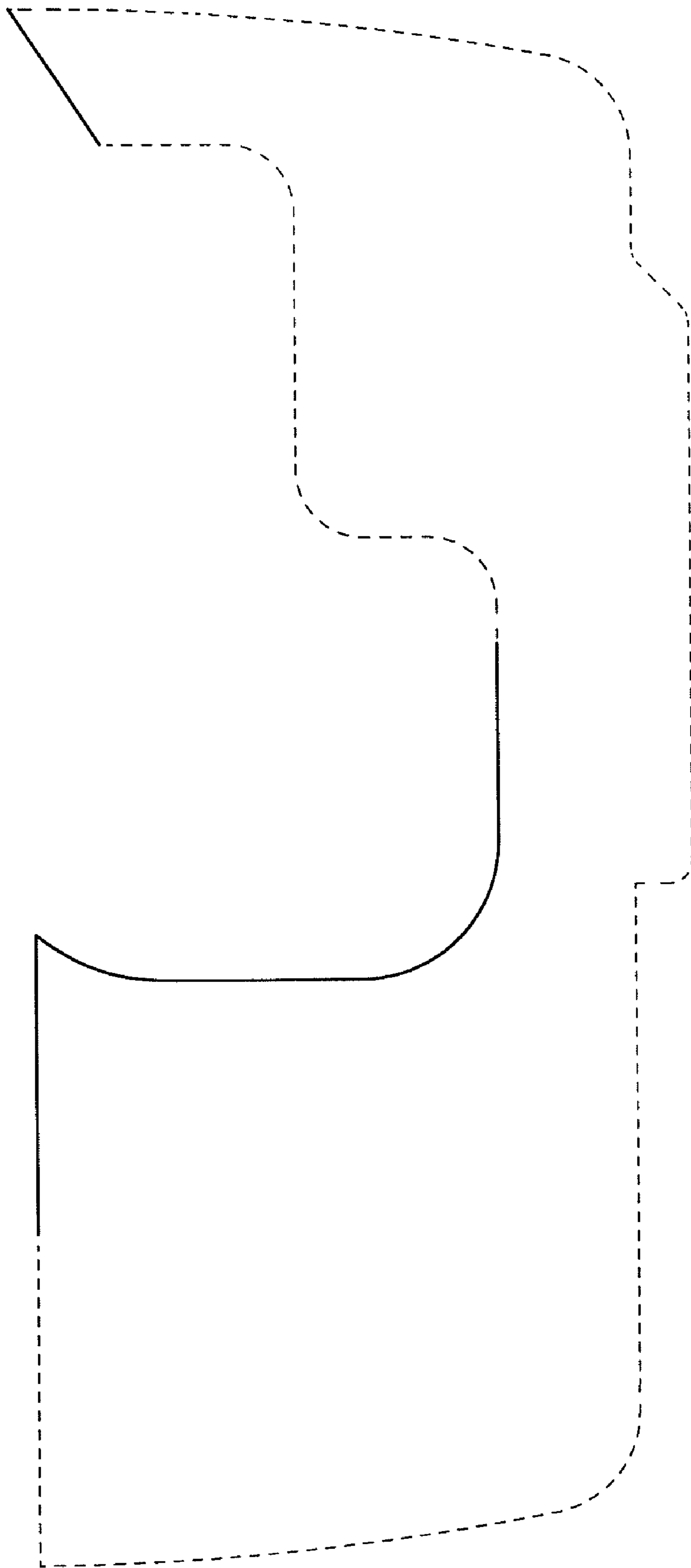

FIG. 5

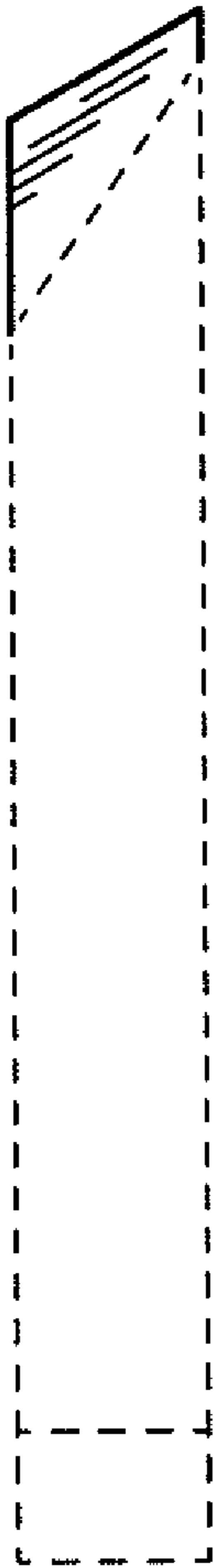

FIG. 6

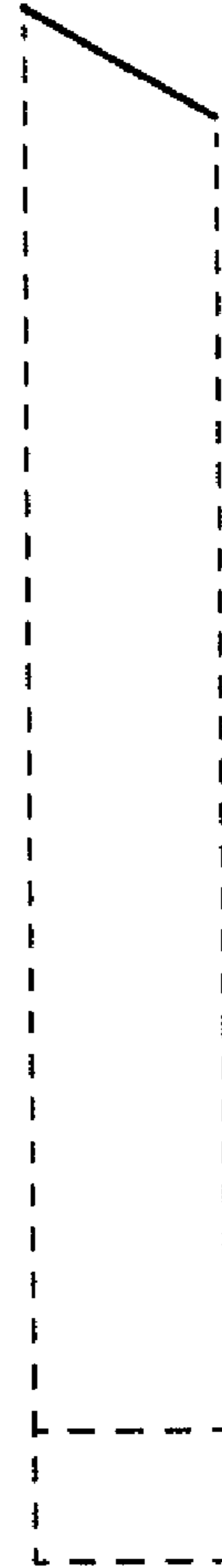

FIG. 7