



US00D605562S

(12) **United States Design Patent**  
**Kitayama et al.**

(10) **Patent No.:** **US D605,562 S**

(45) **Date of Patent:** **\*\* Dec. 8, 2009**

(54) **MOTOR SCOOTER OR MOTOR SCOOTER REPLICA**

(75) Inventors: **Kyosuke Kitayama**, Wako (JP);  
**Tomotake Shimoji**, Wako (JP); **Paolo Cuccagna**, Rome (IT)

(73) Assignee: **Honda Motor Co., Ltd.**, Tokyo (JP)

(\*\*) Term: **14 Years**

(21) Appl. No.: **29/331,980**

(22) Filed: **Feb. 6, 2009**

(30) **Foreign Application Priority Data**

Aug. 6, 2008 (JP) ..... 2008-020393

(51) **LOC (9) Cl.** ..... **12-11**

(52) **U.S. Cl.** ..... **D12/110**

(58) **Field of Classification Search** ..... D12/110;  
180/219, 220

See application file for complete search history.

(56) **References Cited**

**U.S. PATENT DOCUMENTS**

D399,174 S \* 10/1998 Takeshita et al. .... D12/110

D427,944 S \* 7/2000 Sakuma et al. .... D12/110

D443,849 S \* 6/2001 Chen ..... D12/110

D455,677 S \* 4/2002 Kokubu et al. .... D12/110

D596,535 S \* 7/2009 Katagiri et al. .... D12/110

\* cited by examiner

*Primary Examiner*—Cathron C Brooks

*Assistant Examiner*—Linda G. Brooks

(74) *Attorney, Agent, or Firm*—Westerman, Hattori, Daniels & Adrian, LLP

(57) **CLAIM**

The ornamental design for a motor scooter or motor scooter replica, as shown and described.

**DESCRIPTION**

FIG. 1 is a front, elevation view of a motor scooter or motor scooter replica showing our new design;

FIG. 2 is a rear, elevation view thereof;

FIG. 3 is a top, plan view thereof;

FIG. 4 is a bottom, plan view thereof;

FIG. 5 is a right-side elevation view thereof;

FIG. 6 is a left-side elevation view thereof;

FIG. 7 is a left-front perspective view thereof;

FIG. 8 is a right-front perspective view thereof;

FIG. 9 is a left-rear perspective view thereof; and,

FIG. 10 is a right-rear perspective view thereof.

The portions shown in broken lines form no part of the claimed design.

**1 Claim, 5 Drawing Sheets**

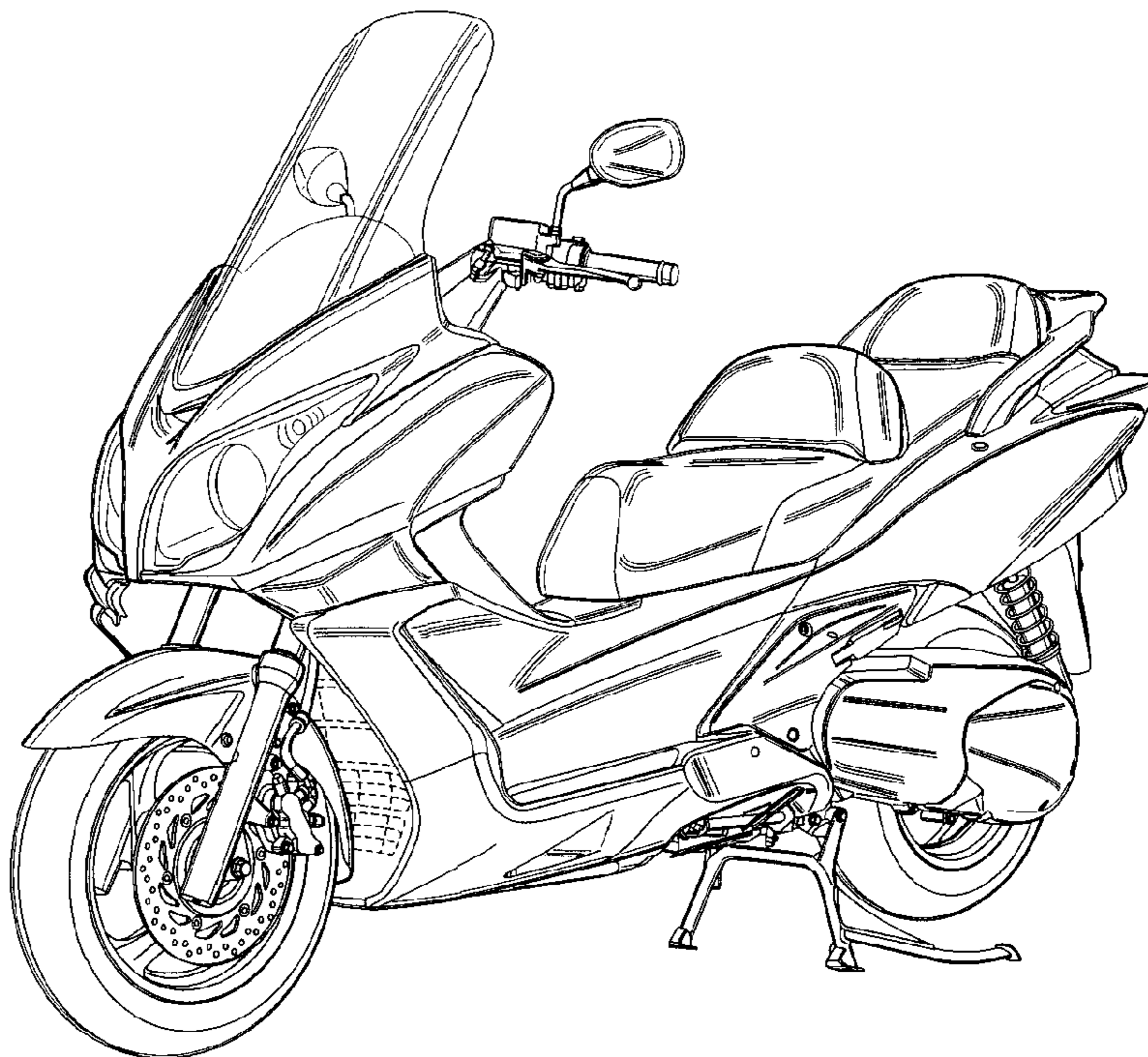
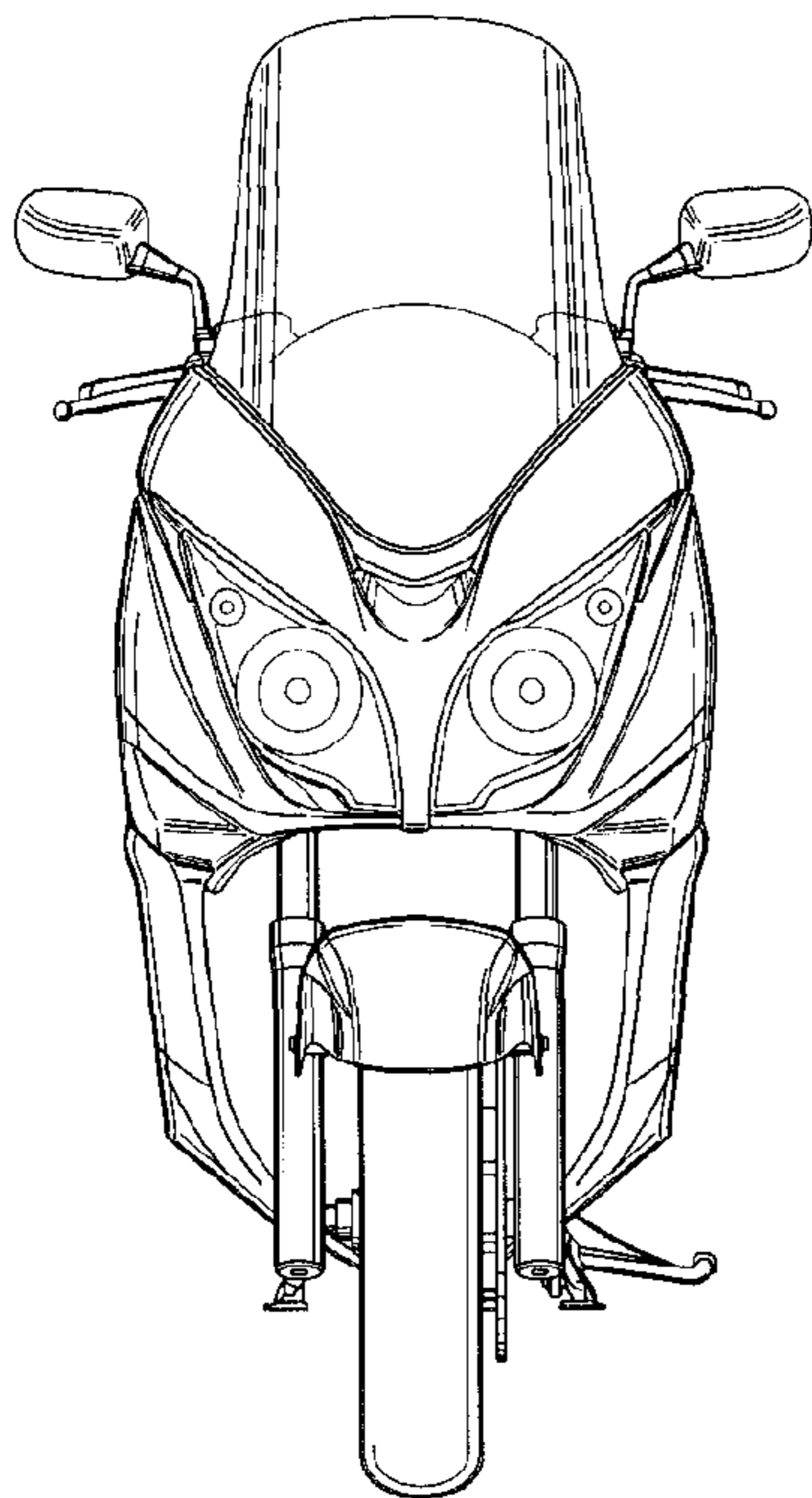

FIG.1

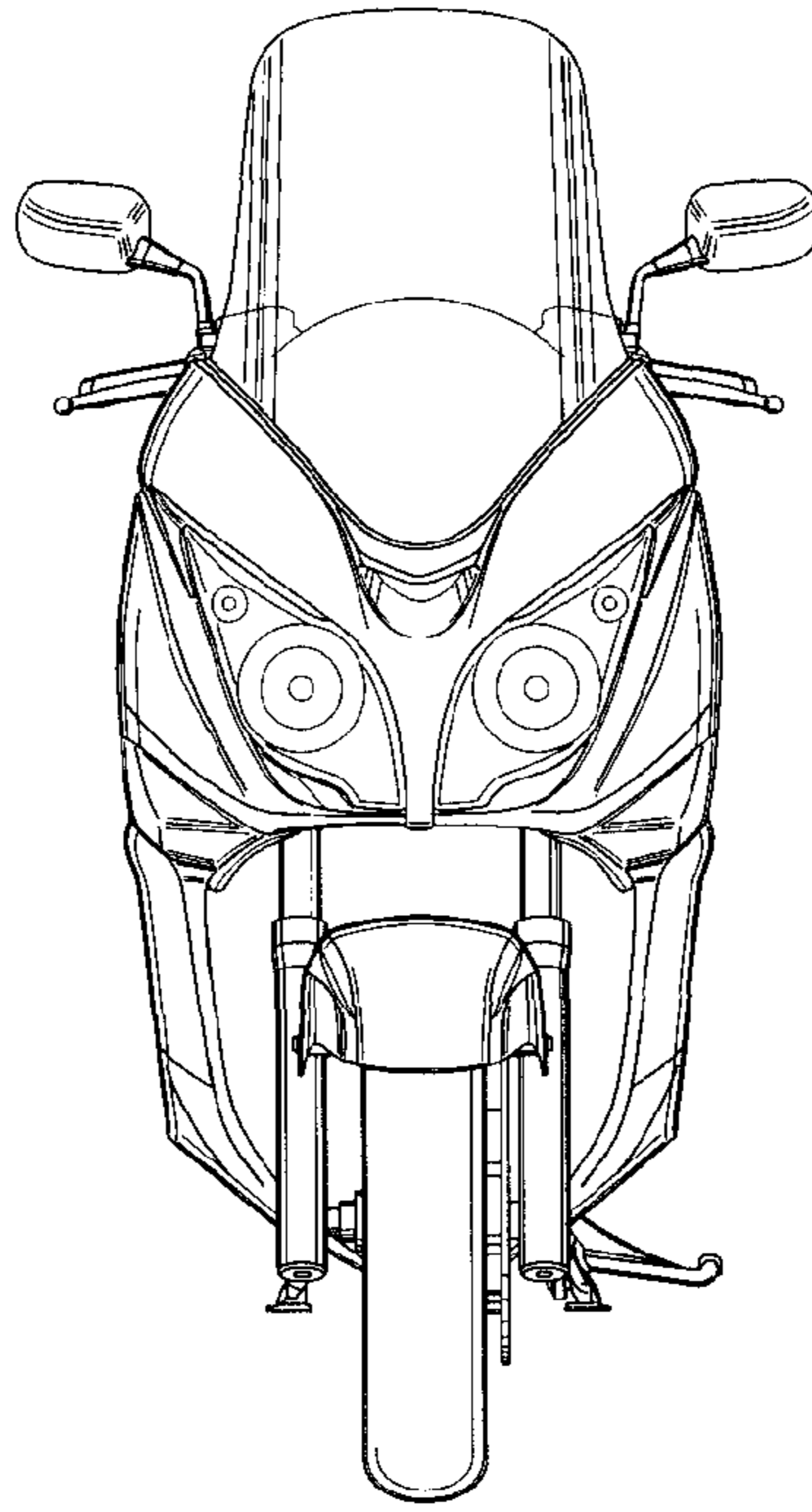

FIG.2

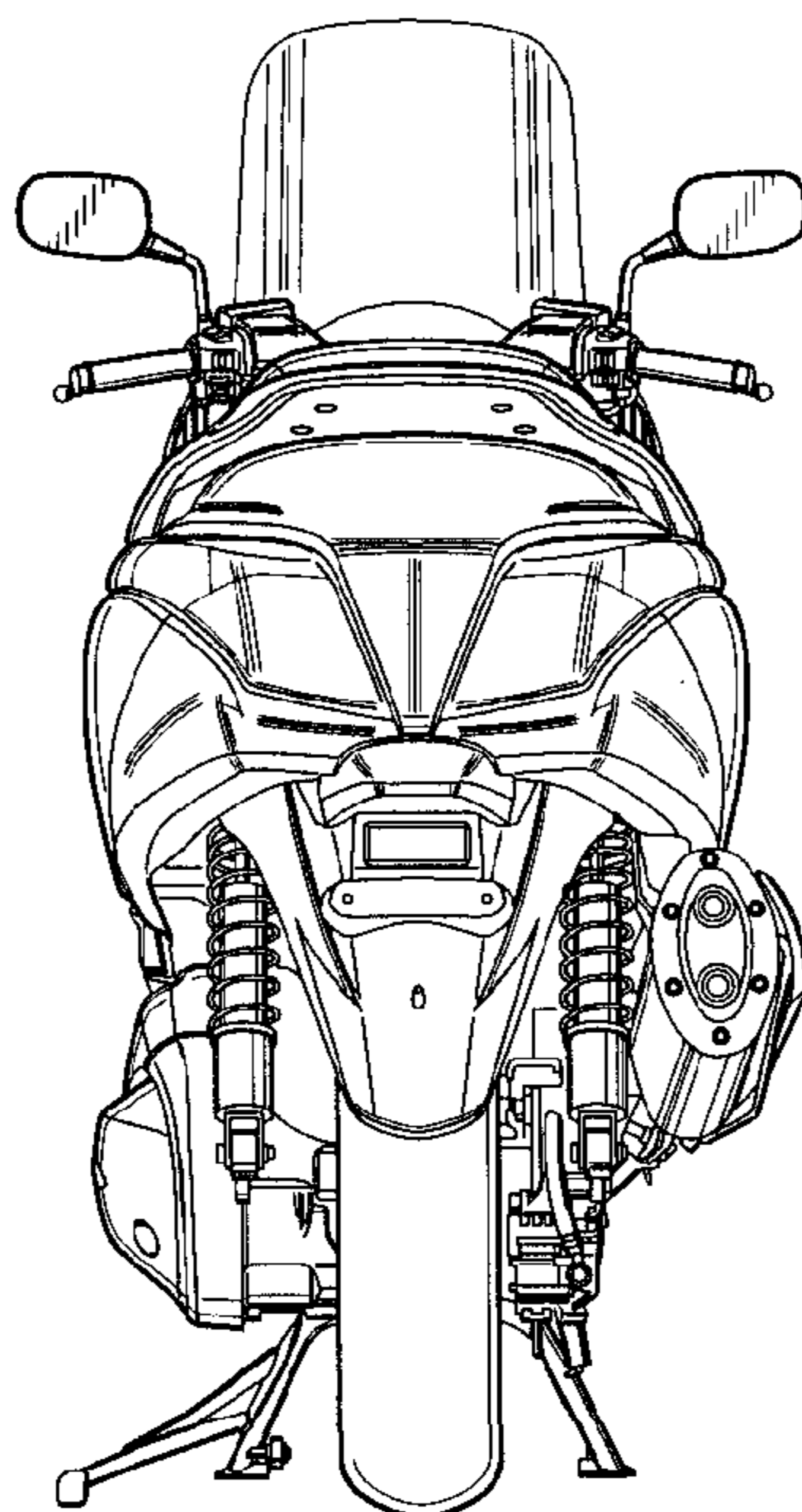

FIG.3

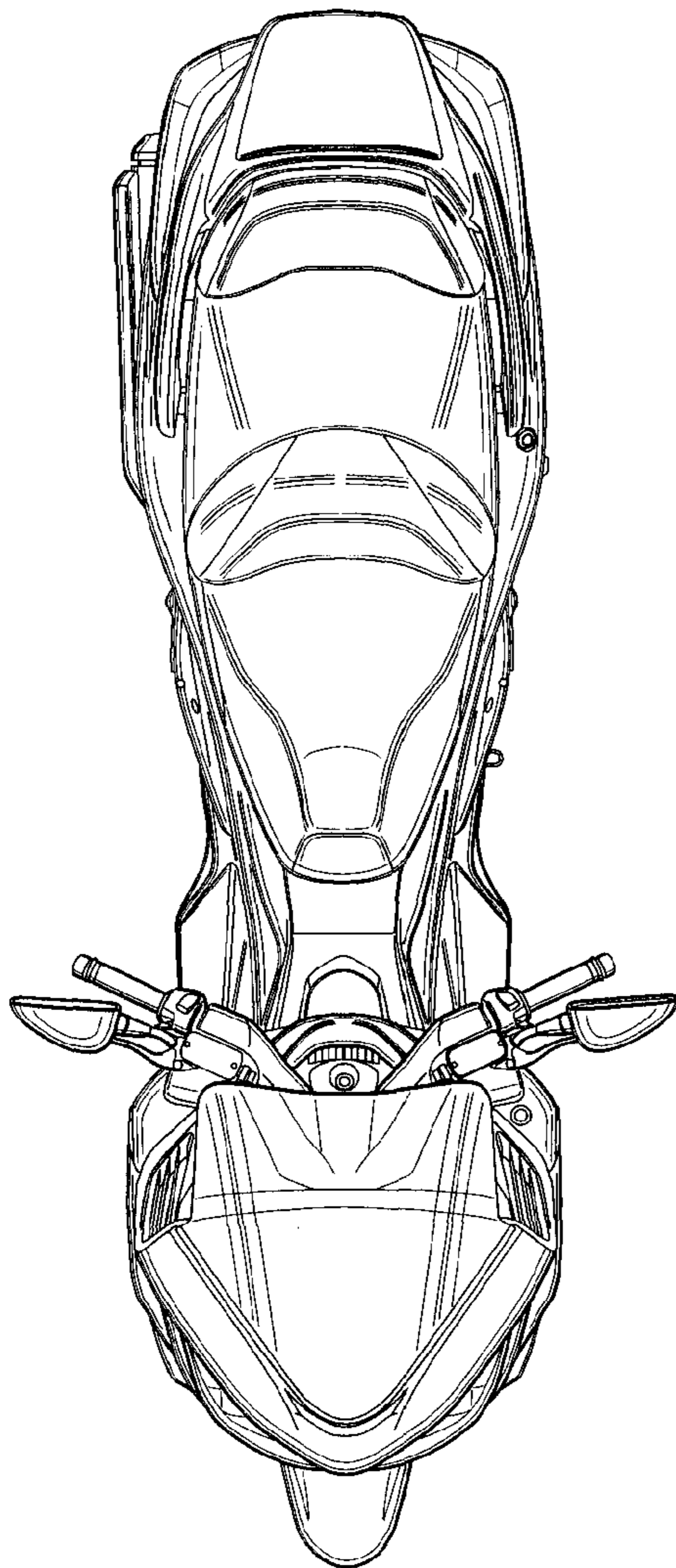

FIG.4

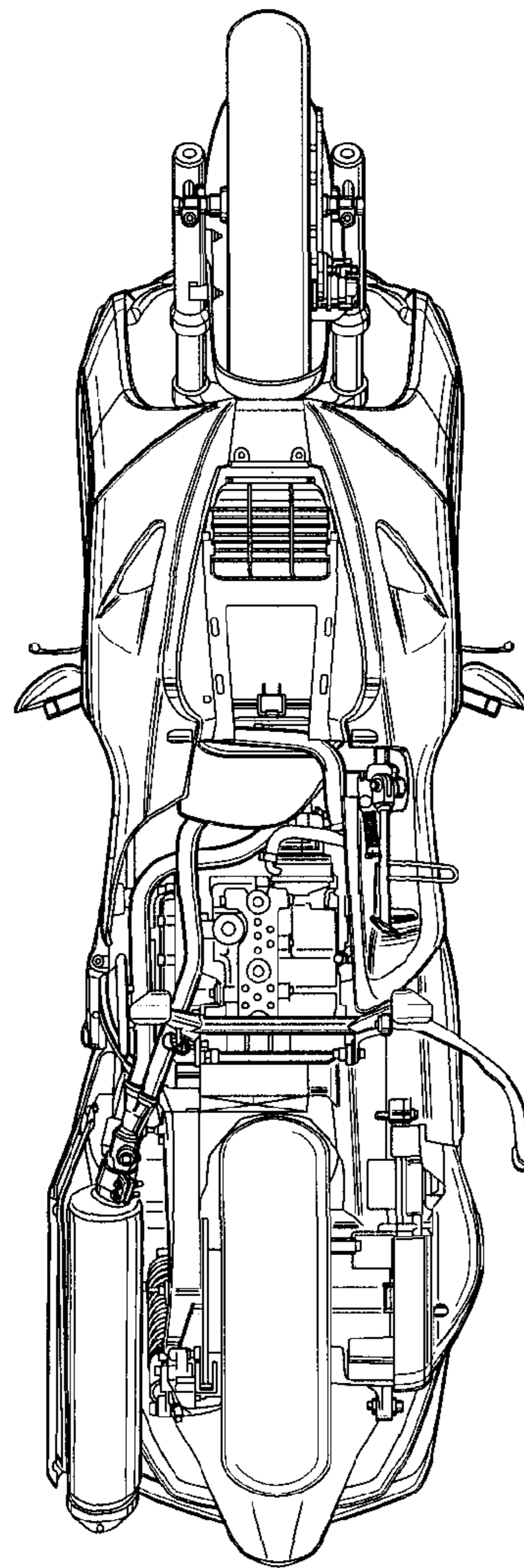

FIG.5

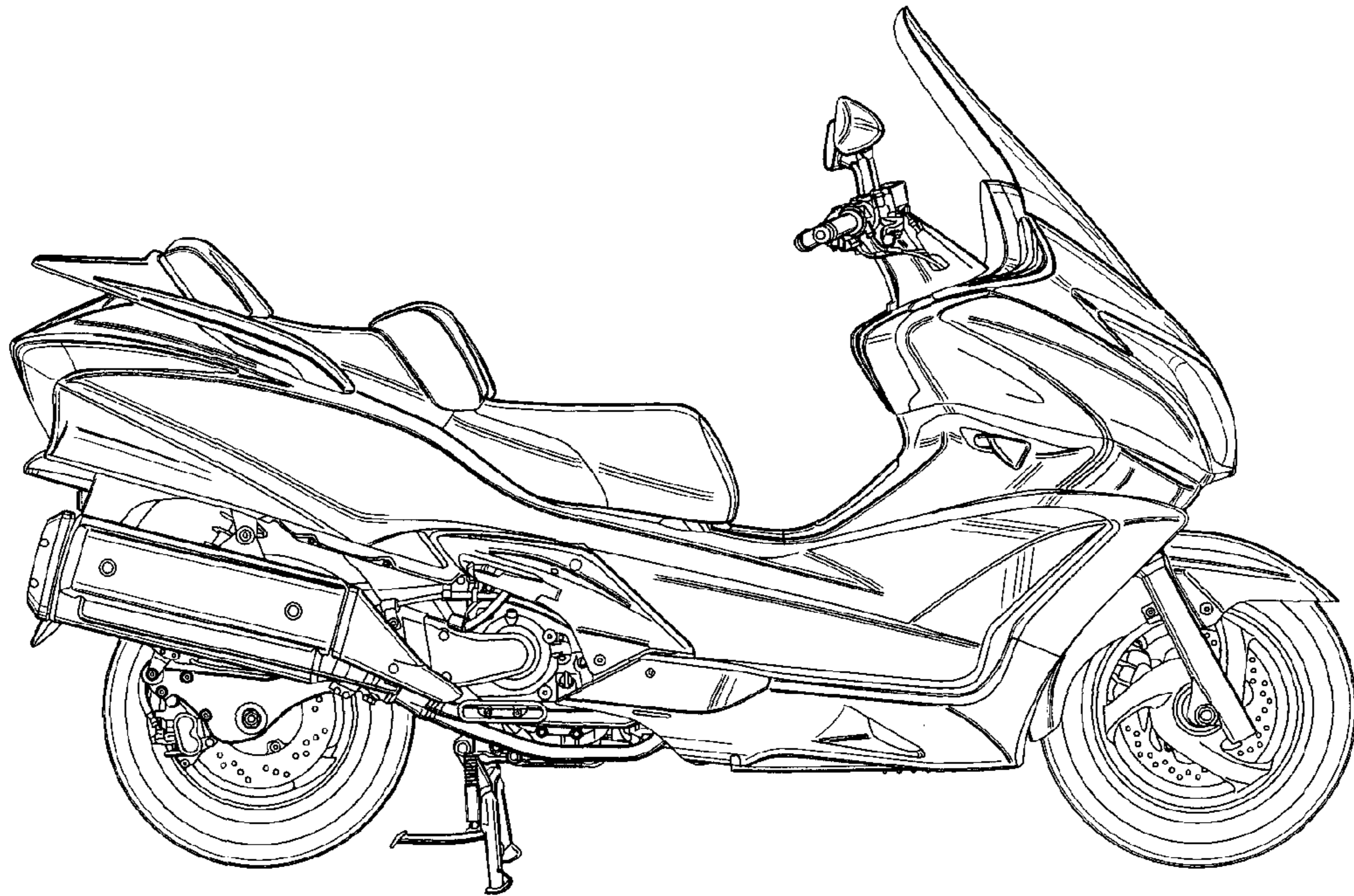

FIG.6

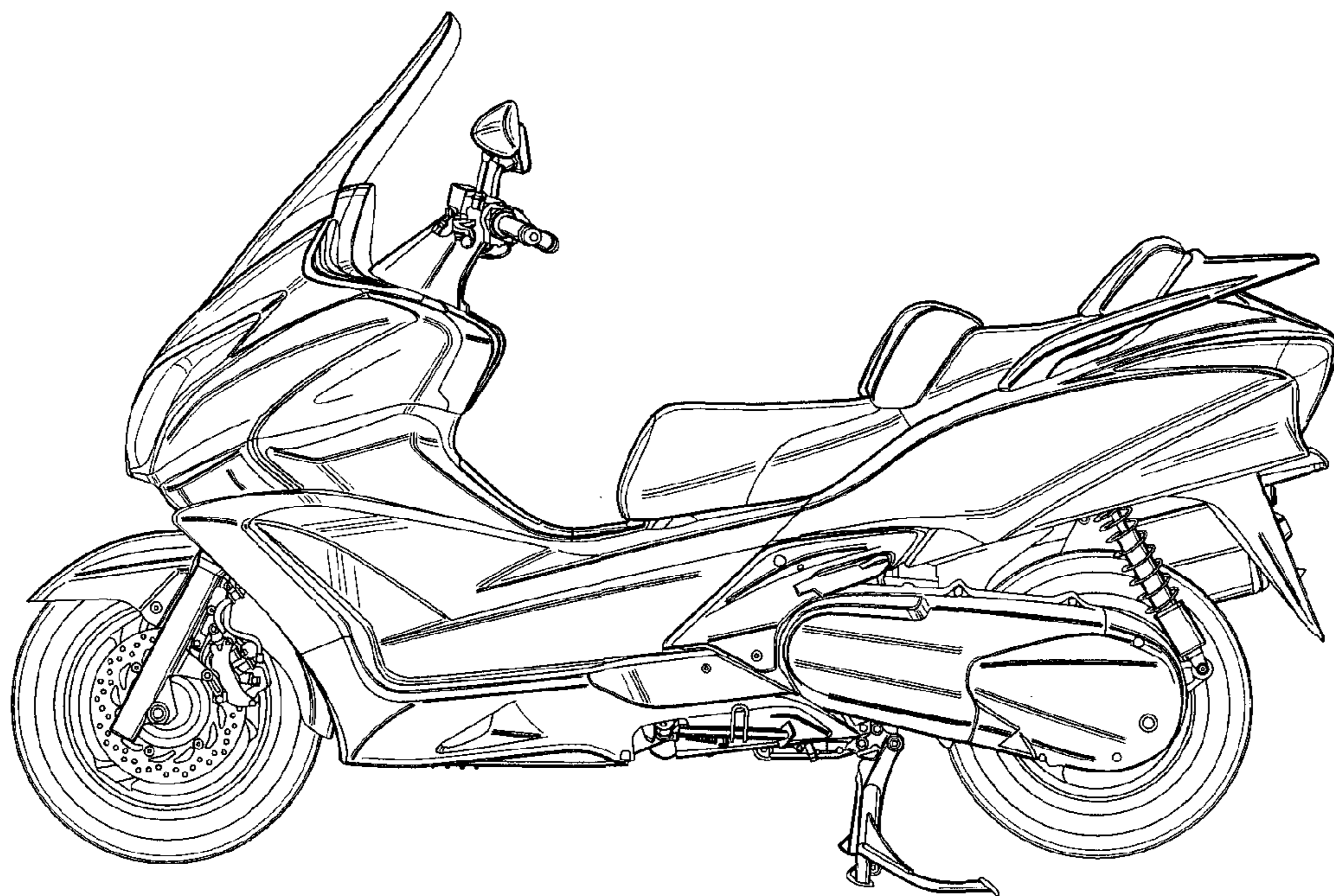

FIG.7

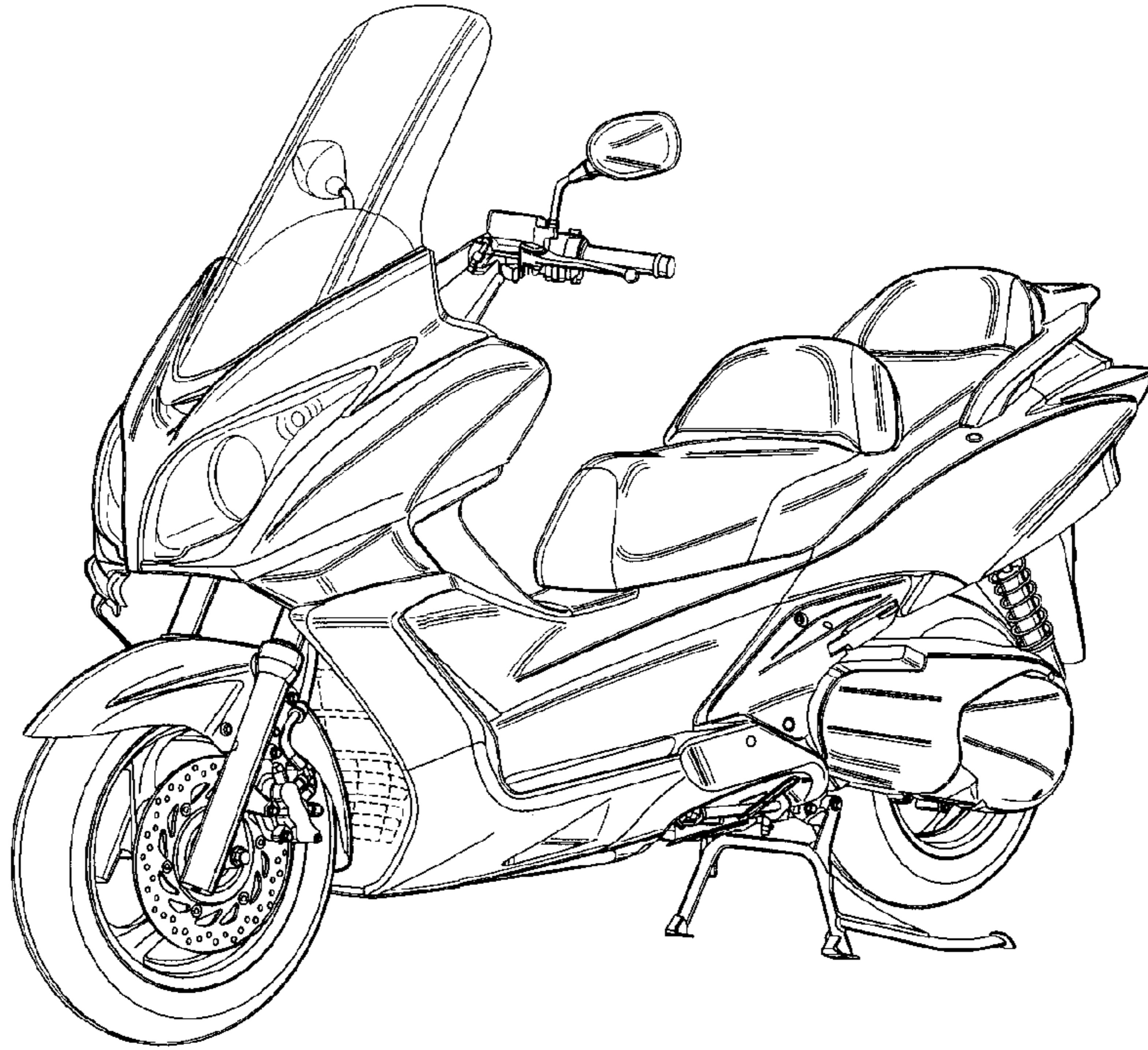

FIG.8

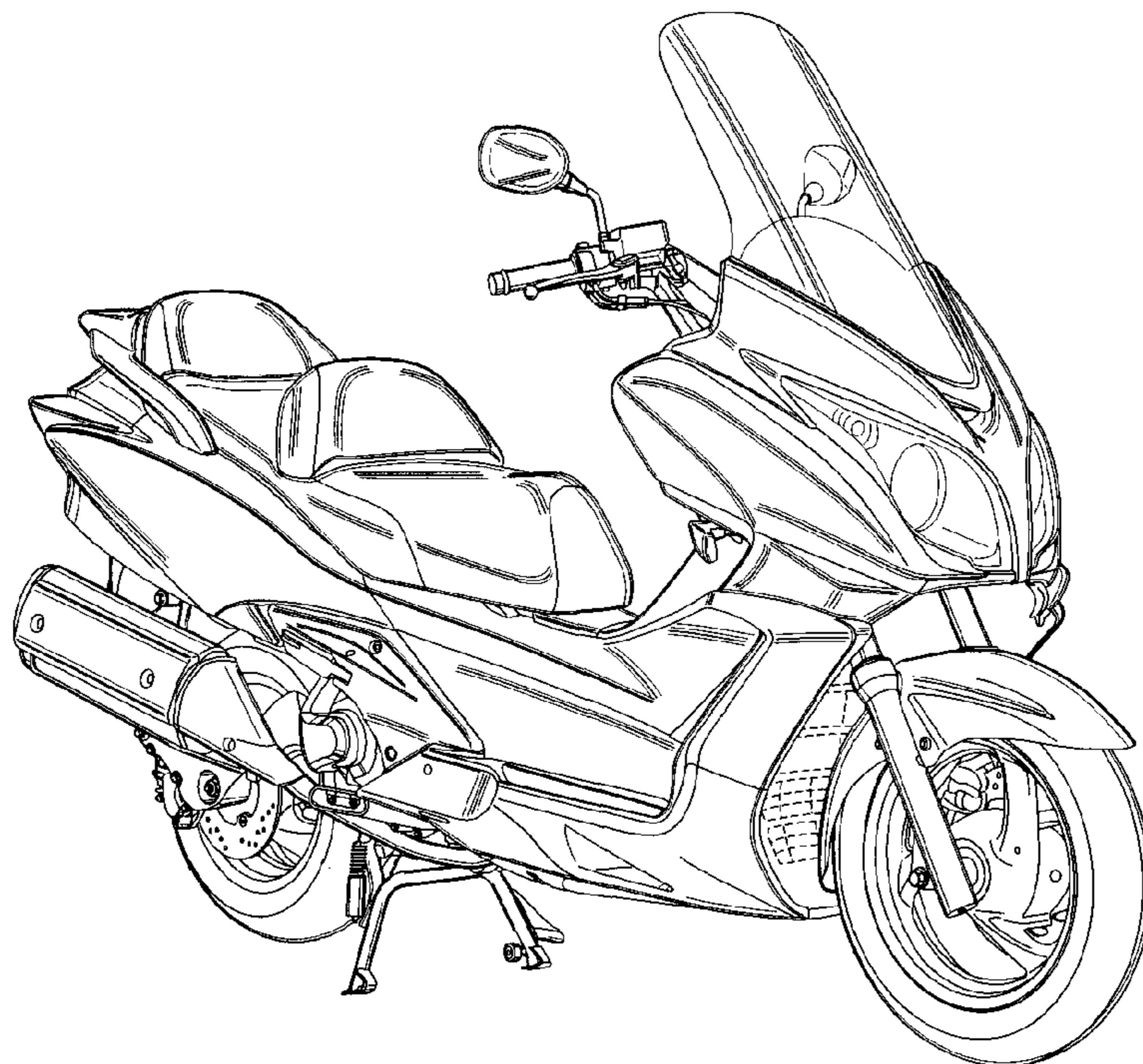

FIG.9

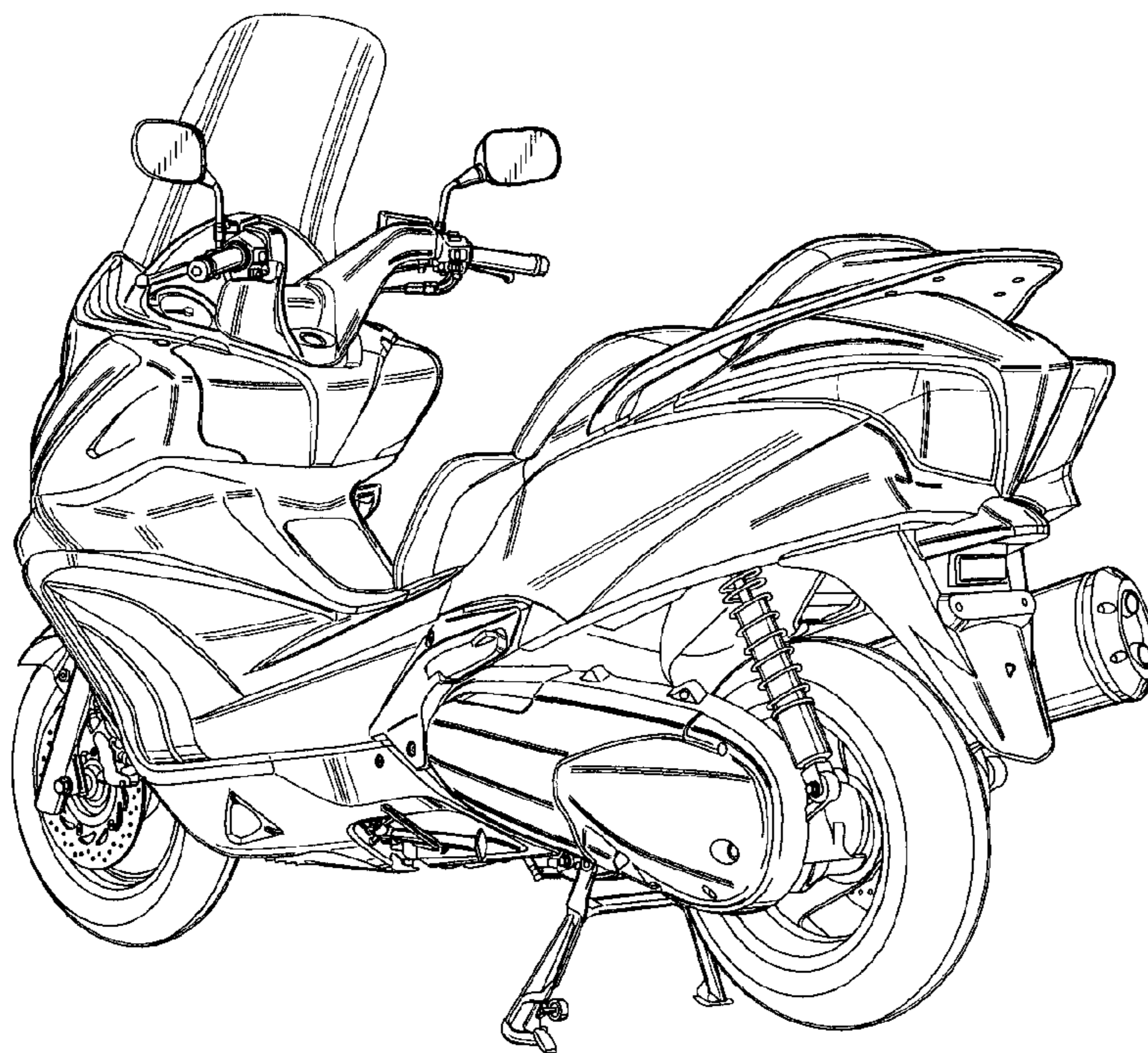

FIG.10

