



US00D605444S

(12) **United States Design Patent**  
**Marietta-Tondin**

(10) **Patent No.:** **US D605,444 S**

(45) **Date of Patent:** **\*\* \*Dec. 8, 2009**

(54) **PAPER DISPENSER**

(75) Inventor: **Julien Marietta-Tondin**, Marckolsheim  
(FR)

(73) Assignee: **Georgia-Pacific France** (FR)

(\*\*) Term: **14 Years**

(21) Appl. No.: **29/306,665**

(22) Filed: **Apr. 14, 2008**

(30) **Foreign Application Priority Data**

Oct. 31, 2007 (EM) ..... 000819875

(51) **LOC (9) Cl.** ..... **23-02**

(52) **U.S. Cl.** ..... **D6/523**

(58) **Field of Classification Search** ..... D6/515,  
D6/518, 520, 523; 242/560, 560.3, 570,  
242/590-598; 312/34.1; 206/389; 211/85.5  
See application file for complete search history.

(56) **References Cited**

U.S. PATENT DOCUMENTS

- 5,265,816 A 11/1993 Collins
- 5,310,129 A \* 5/1994 Whittington et al. .... 242/560.3
- D351,520 S \* 10/1994 Frazier et al. .... D6/523
- D351,749 S \* 10/1994 Omdoll et al. .... D6/523
- D373,276 S 9/1996 Omdoll et al.

- D436,774 S \* 1/2001 Engelstein et al. .... D6/522
- D458,490 S \* 6/2002 Omdoll et al. .... D6/523
- D556,482 S \* 12/2007 Goeking et al. .... D6/520

FOREIGN PATENT DOCUMENTS

FR 522565 11/1998

\* cited by examiner

*Primary Examiner*—Brian N Vinson

(74) *Attorney, Agent, or Firm*—Joel T. Charlton

(57) **CLAIM**

The ornamental design for a paper dispenser, as shown and described.

**DESCRIPTION**

FIG. 1 is a top, front, and right side perspective view of a paper dispenser showing our new design;

FIG. 2 is a bottom plan view thereof;

FIG. 3 is a front elevational view thereof;

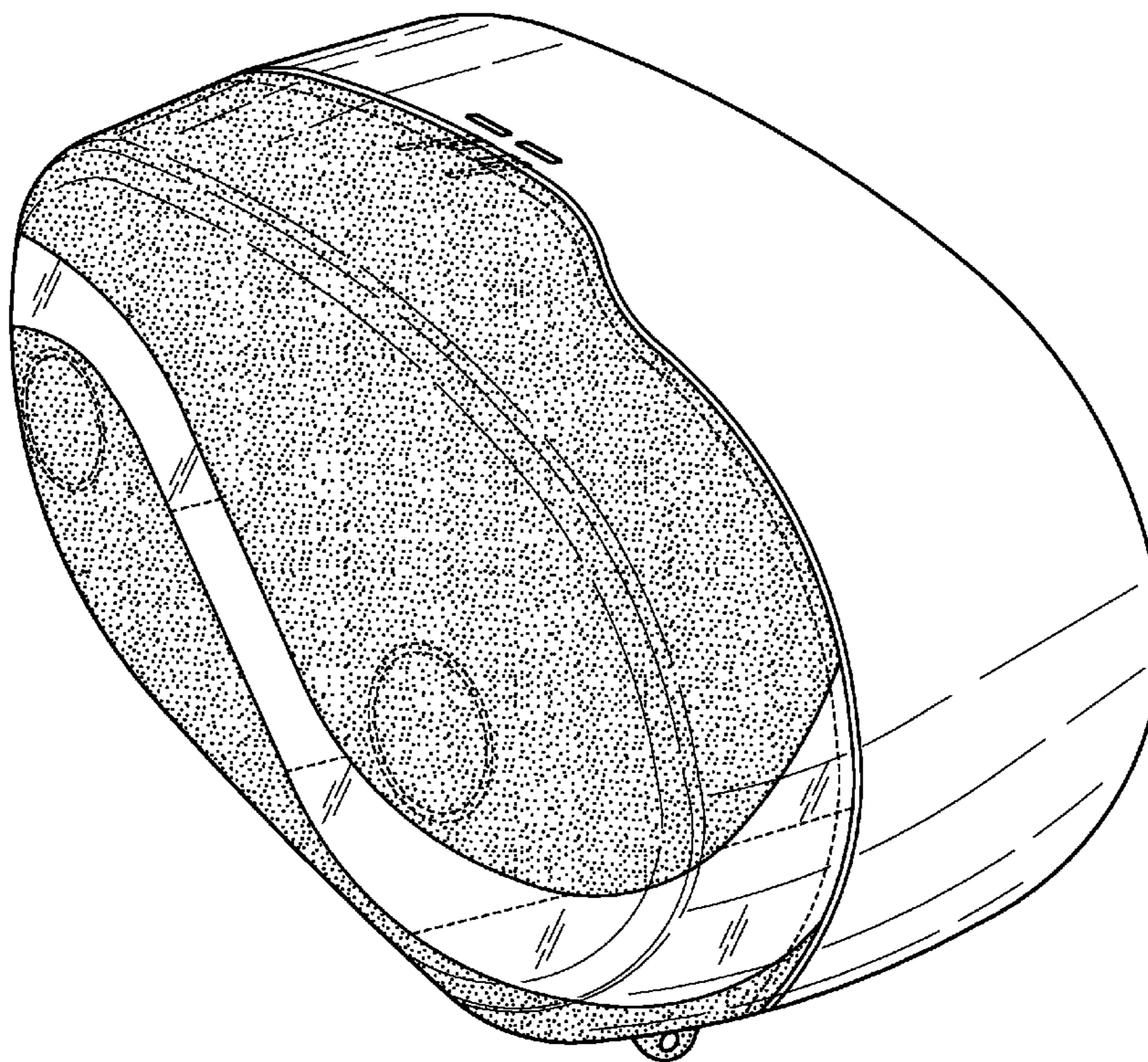
FIG. 4 is a top plan view thereof;

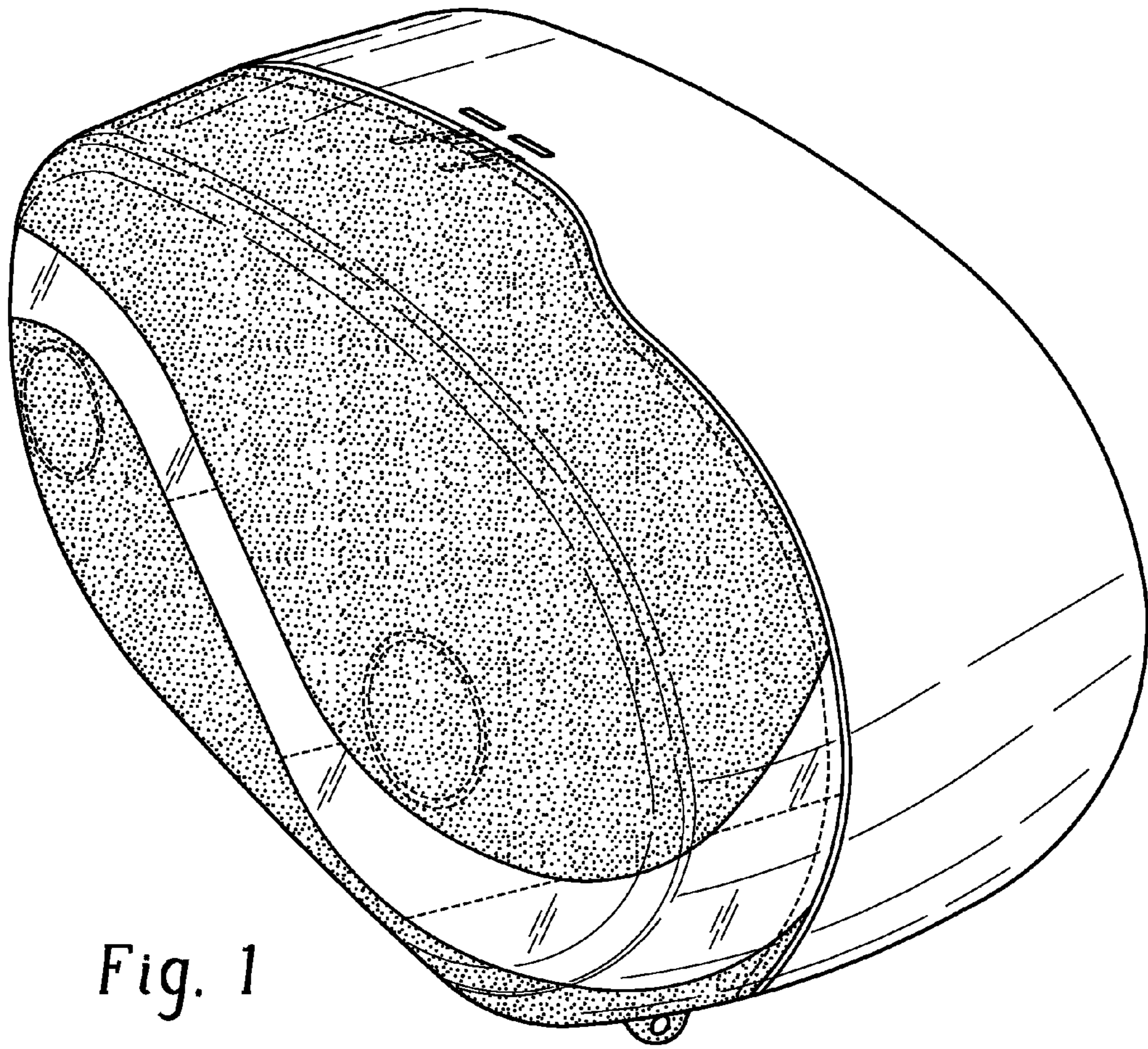
FIG. 5 is a right side elevational view thereof; and,

FIG. 6 is a left side elevational view thereof.

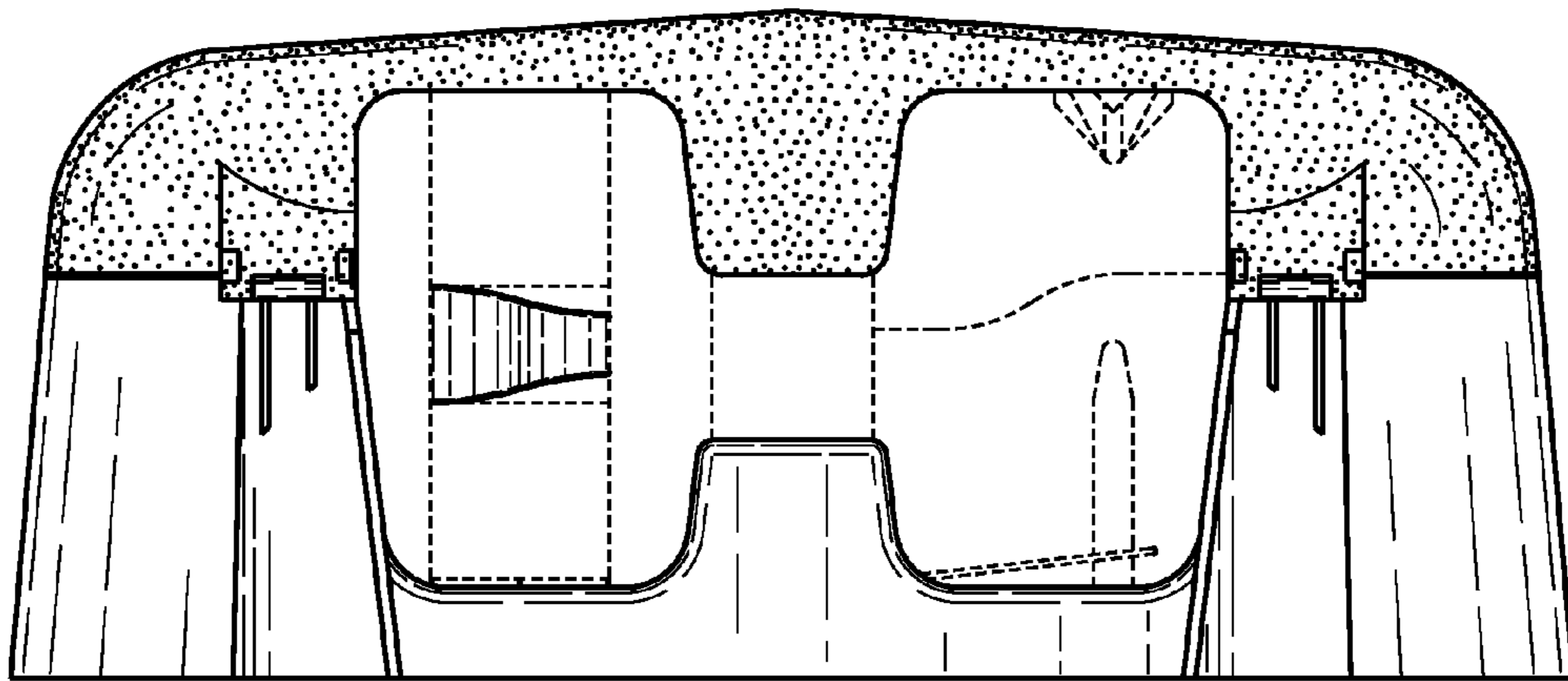
The broken-line disclosure in the views is understood to represent portions of the article in which the claimed design is embodied, but which for no part of the claimed design.

**1 Claim, 3 Drawing Sheets**

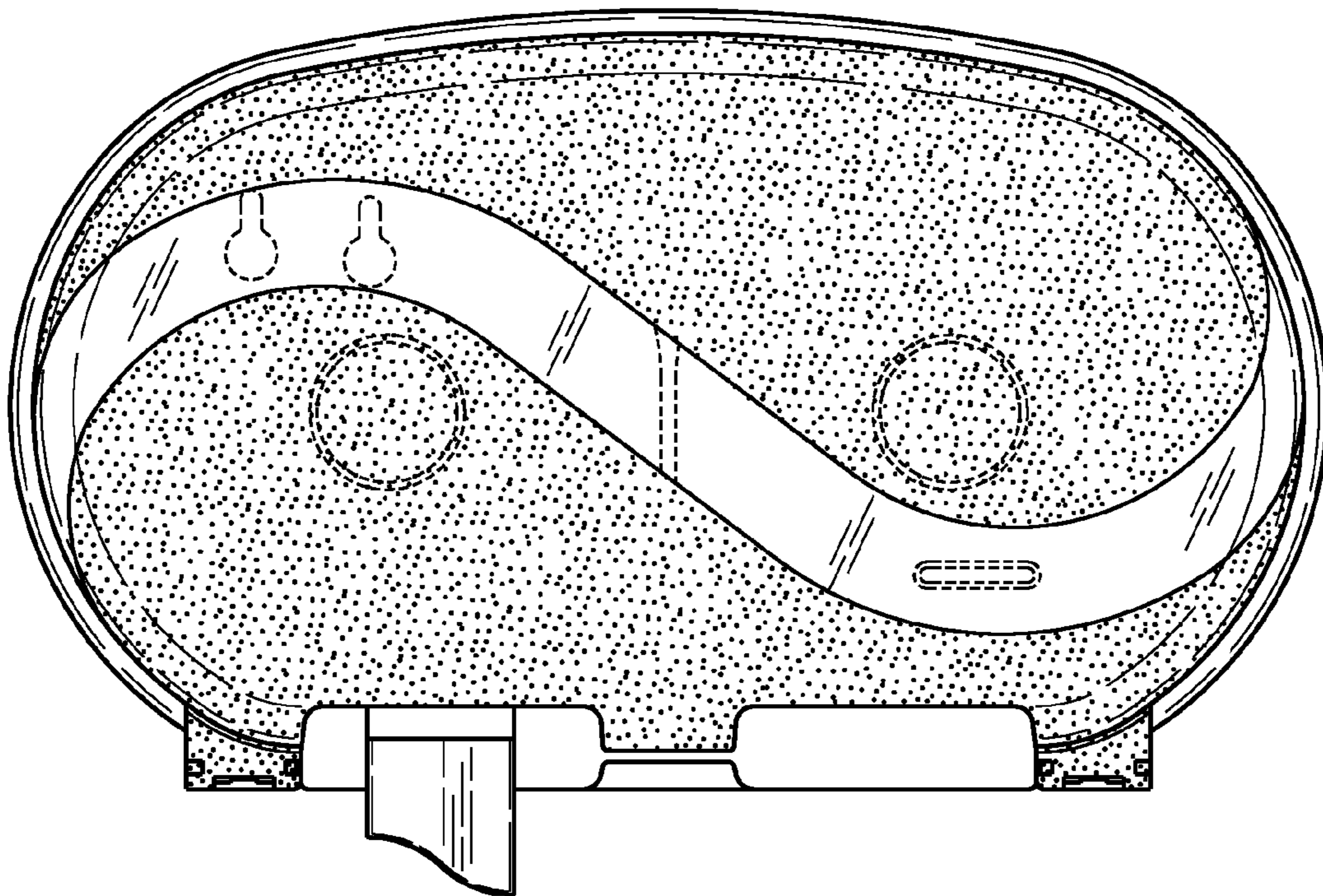




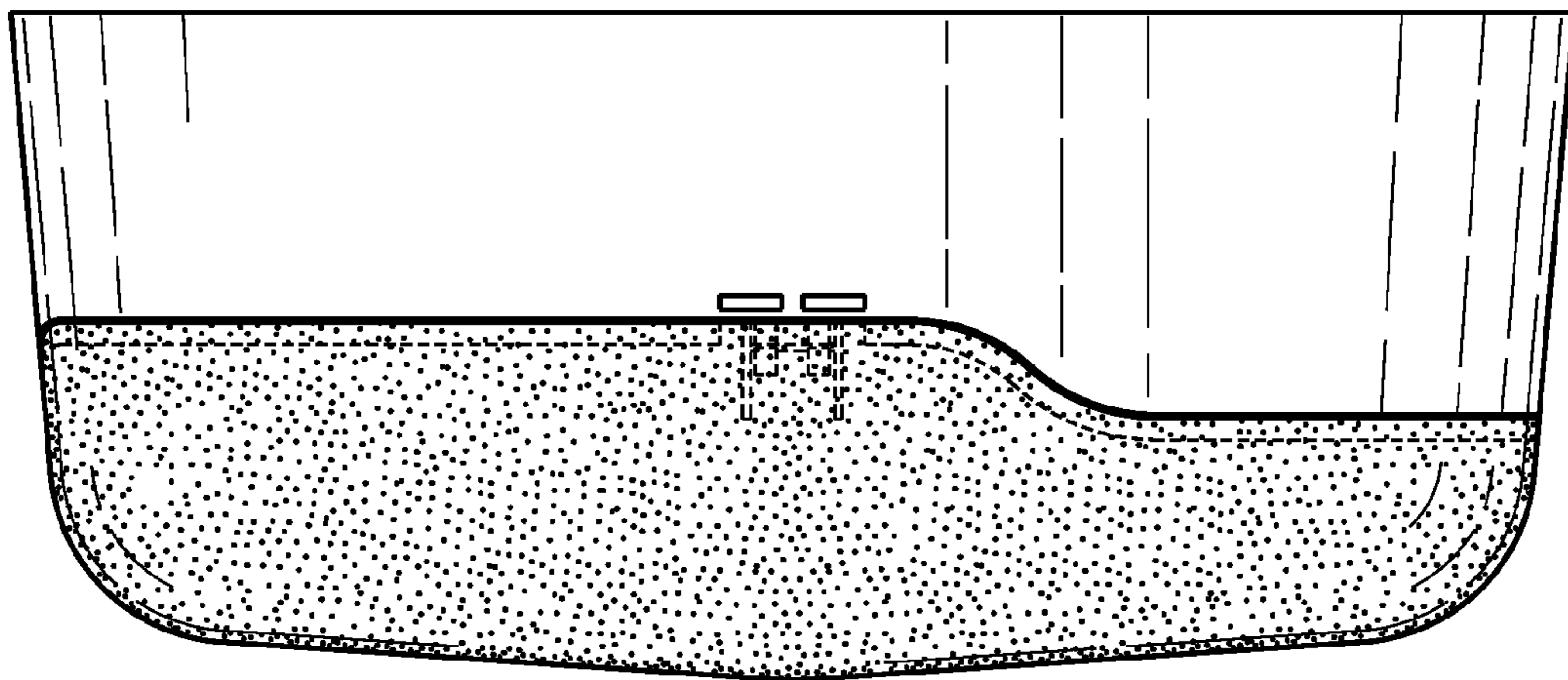
*Fig. 1*



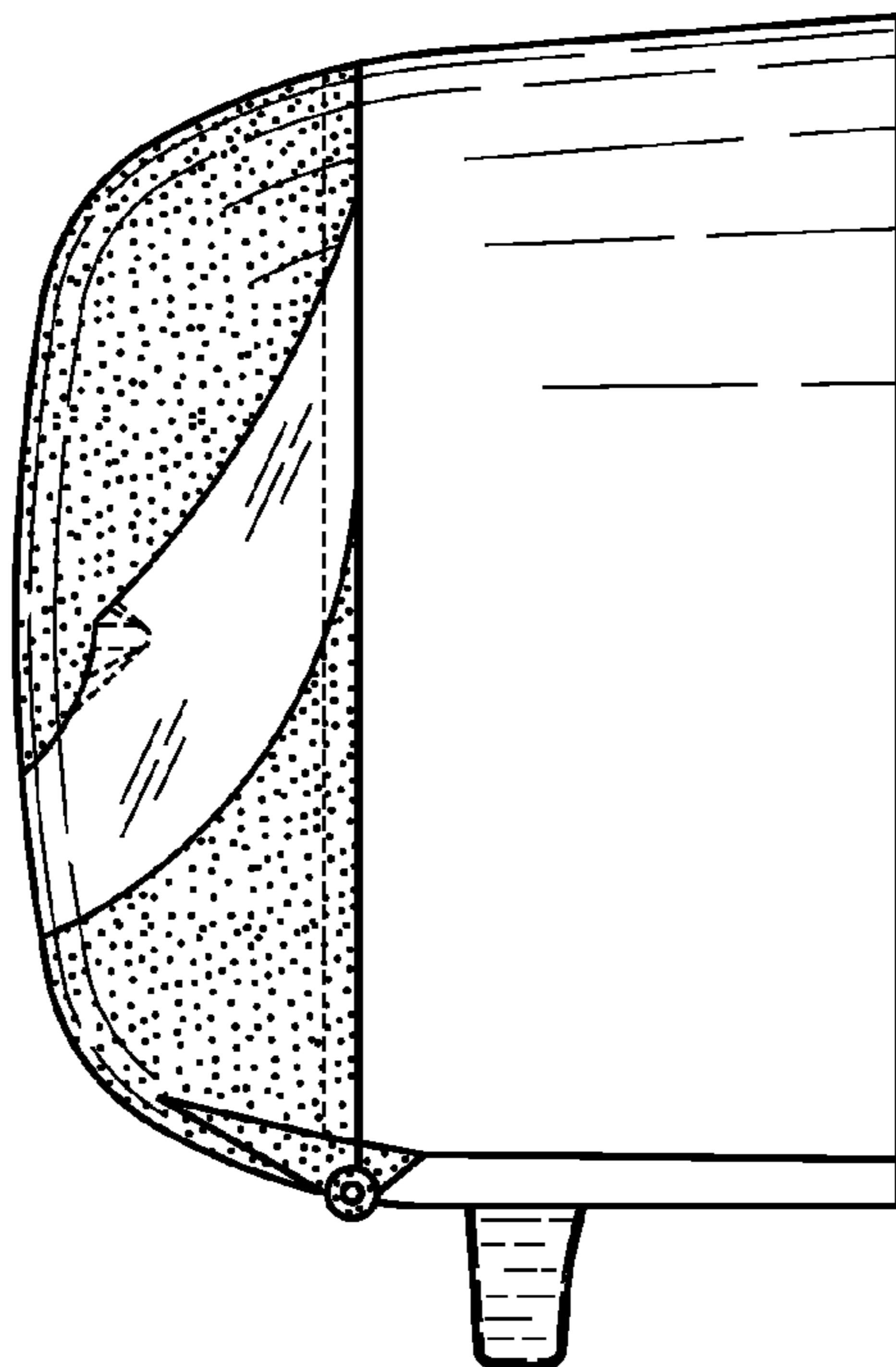
*Fig. 2*



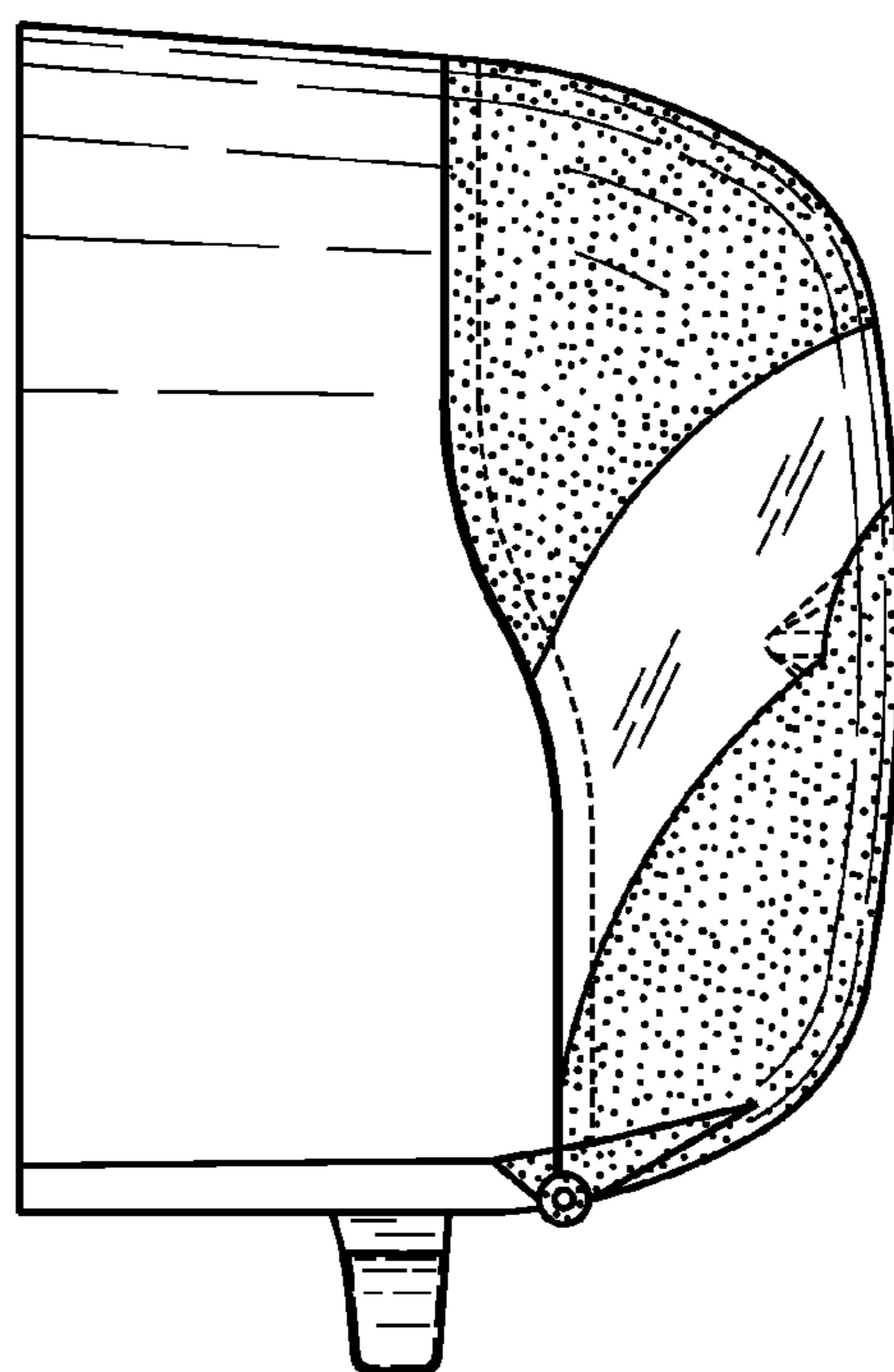
*Fig. 3*



*Fig. 4*



*Fig. 5*



*Fig. 6*