



US00D605427S

(12) **United States Design Patent**
Brooks et al.

(10) **Patent No.:** **US D605,427 S**
(45) **Date of Patent:** **** Dec. 8, 2009**

(54) **EYEWEAR DISPLAY FIXTURE**

D426,984 S * 6/2000 Griffith D6/457
D436,265 S * 1/2001 Kidd et al. D6/457
D562,036 S * 2/2008 Roberts D6/495

(75) Inventors: **Paul C. Brooks**, Barrington, RI (US);
Jonathan R. Brillon, Manville, RI (US);
Joseph A. Frazier, Lincoln, RI (US)

* cited by examiner

(73) Assignee: **Packaging Concepts Ltd.**, Lincoln, RI (US)

Primary Examiner—Caron Veynar

Assistant Examiner—Sydney R Buffalow

(**) Term: **14 Years**

(74) *Attorney, Agent, or Firm*—Weingarten, Schurgin, Gagnebin & Lebovici LLP

(21) Appl. No.: **29/335,089**

(57) **CLAIM**

(22) Filed: **Apr. 8, 2009**

The ornamental design for an eyewear display fixture, as shown.

(51) **LOC (9) Cl.** **06-04**

(52) **U.S. Cl.** **D6/467**

(58) **Field of Classification Search** D6/310,
D6/457, 466, 495, 467, 396, 449; D11/117,
D11/118; 211/13.1, 133.1, 13.4, 96, 194,
211/196, 205, 85.1, 85.2

DESCRIPTION

FIG. 1 is a front perspective view of our new design for an eyewear display fixture;

FIG. 2 is a top plan view;

FIG. 3 is a right elevation view;

FIG. 4 is a front elevation view;

FIG. 5 is a left elevation view;

FIG. 6 is a rear elevation view;

FIG. 7 is a bottom plan view;

FIG. 8 is a detail of the front element shown in FIG. 1; and,

FIG. 9 is a detail of the side element shown in FIG. 1.

See application file for complete search history.

(56) **References Cited**

U.S. PATENT DOCUMENTS

D266,461 S * 10/1982 Helzer D6/310
D344,248 S * 2/1994 Wiggins D11/117
D354,928 S * 1/1995 Hoffman et al. D11/118
D383,909 S * 9/1997 Salas D6/310
D417,802 S * 12/1999 Spurgeon et al. D6/467
D424,329 S * 5/2000 Lundberg D6/457

1 Claim, 1 Drawing Sheet

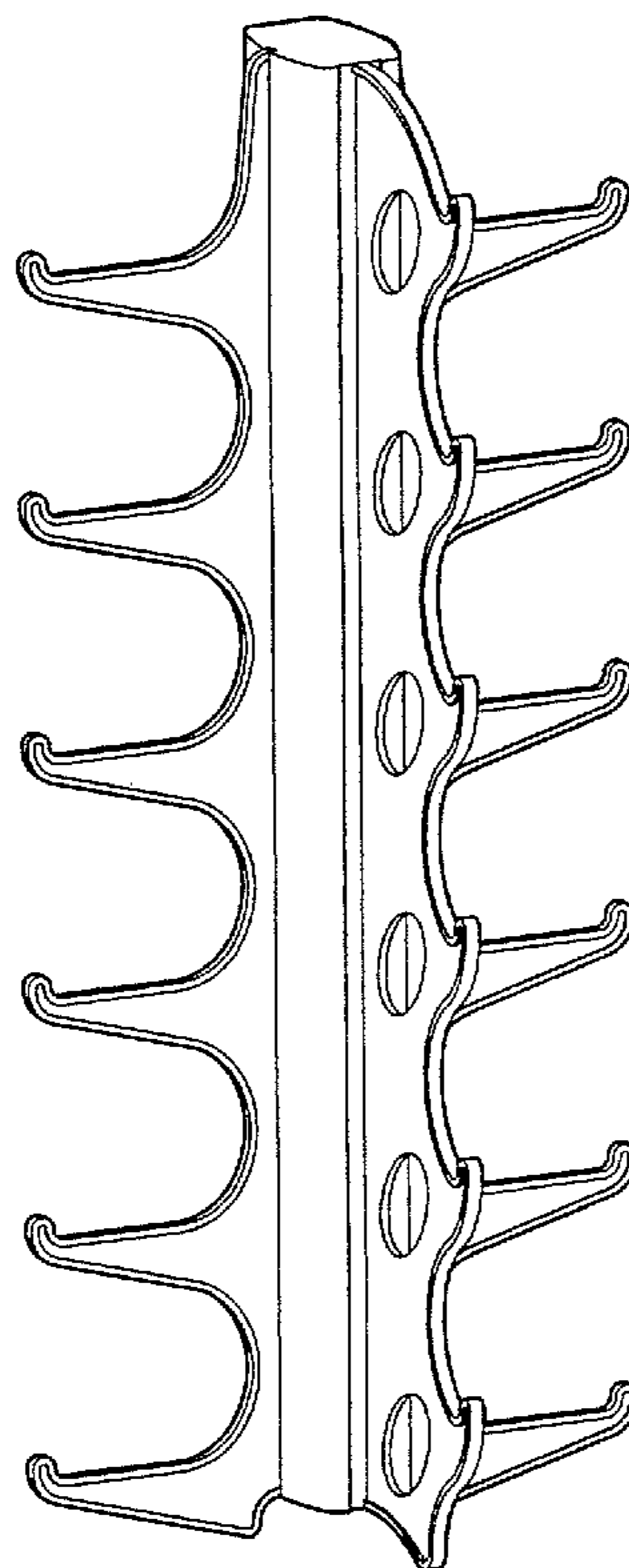

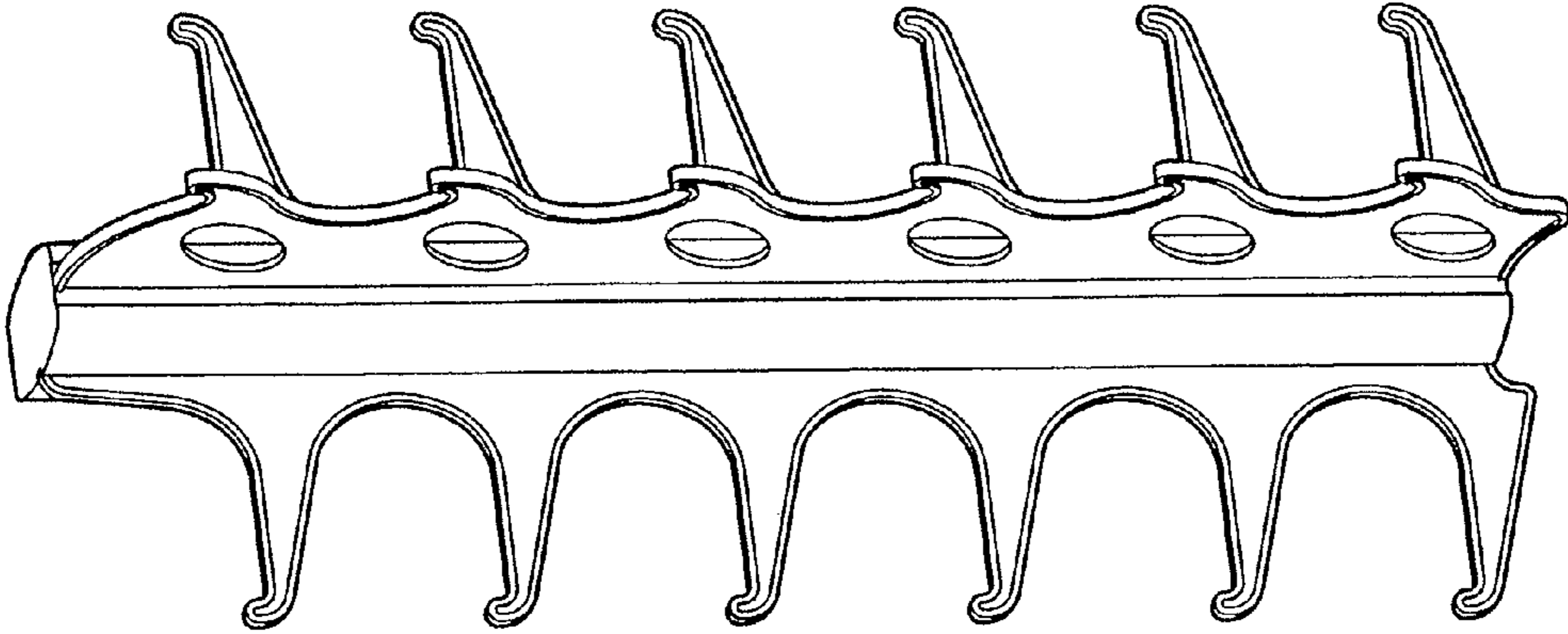

FIG. 1

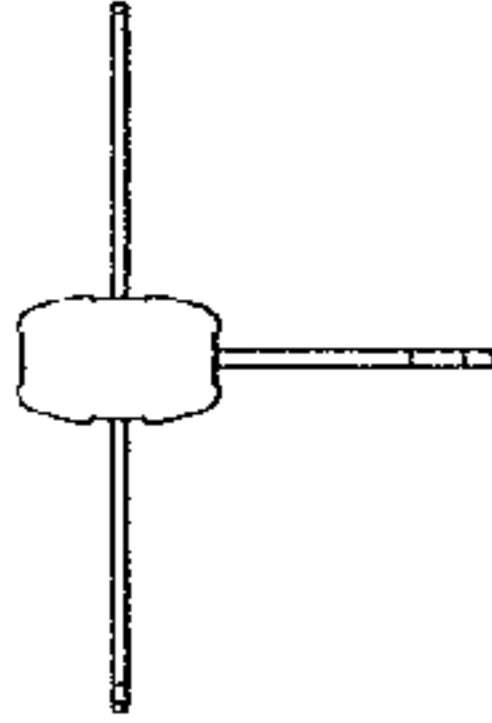

FIG. 2

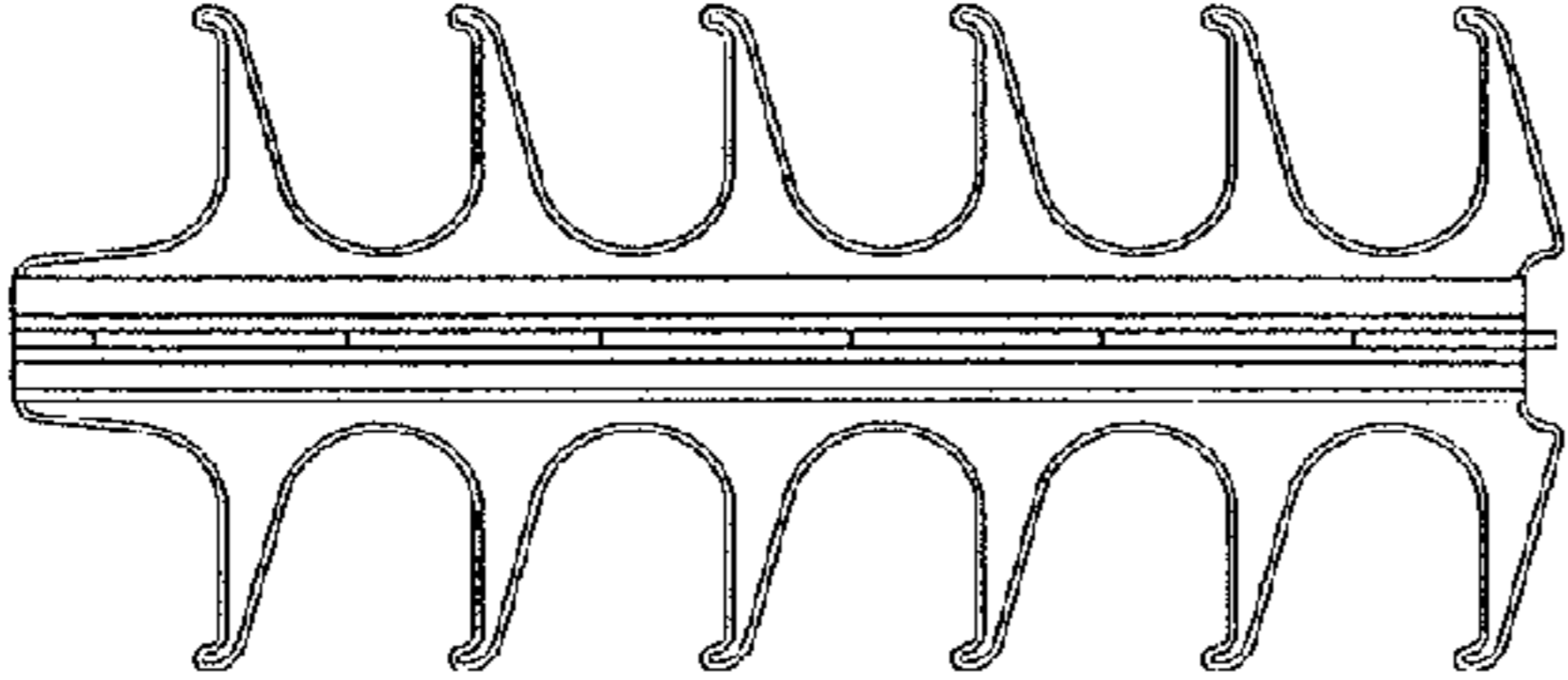

FIG. 4

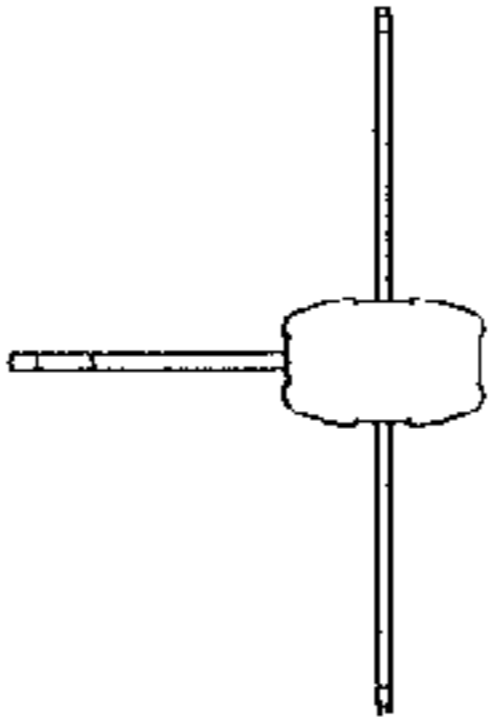

FIG. 7

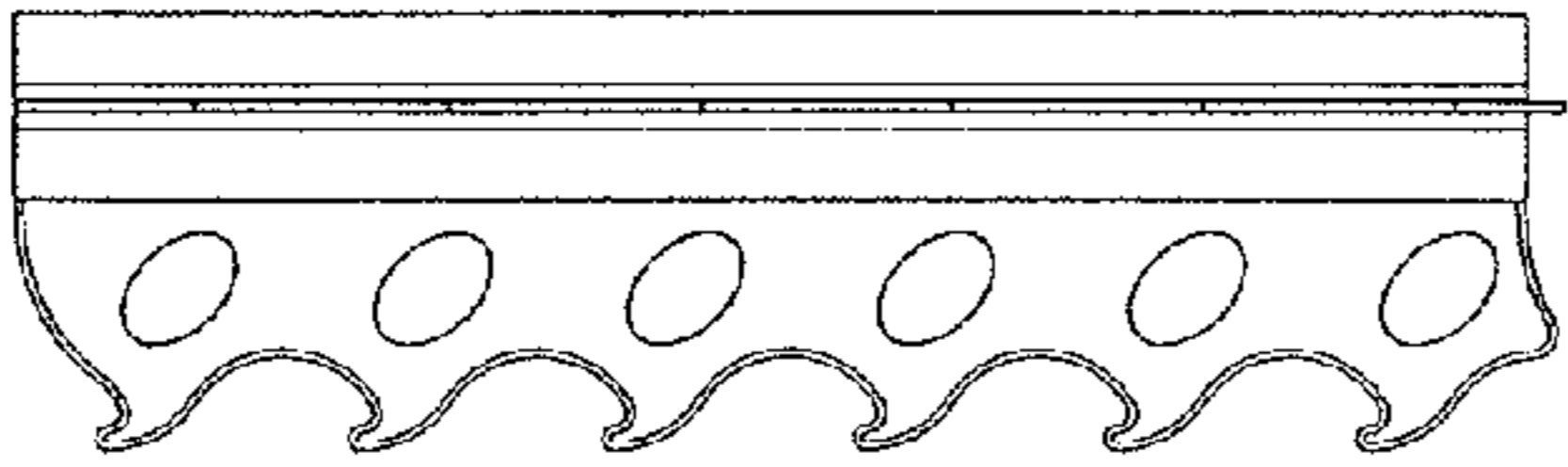

FIG. 3

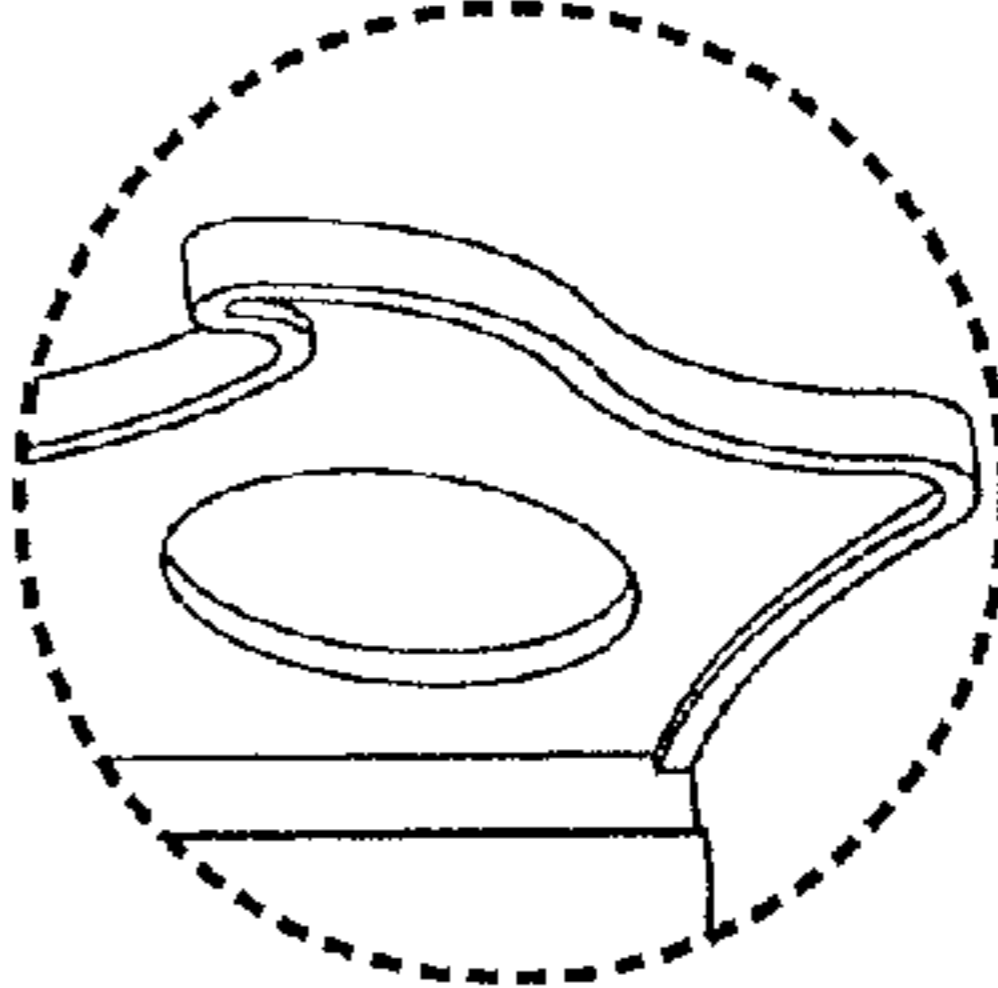

FIG. 8

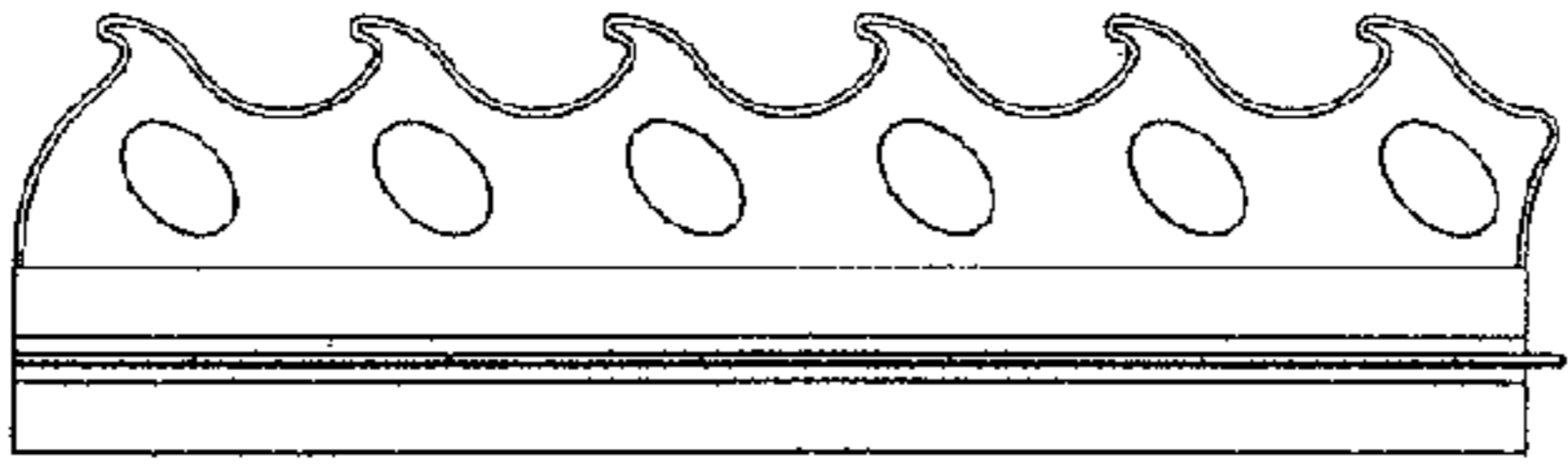

FIG. 5

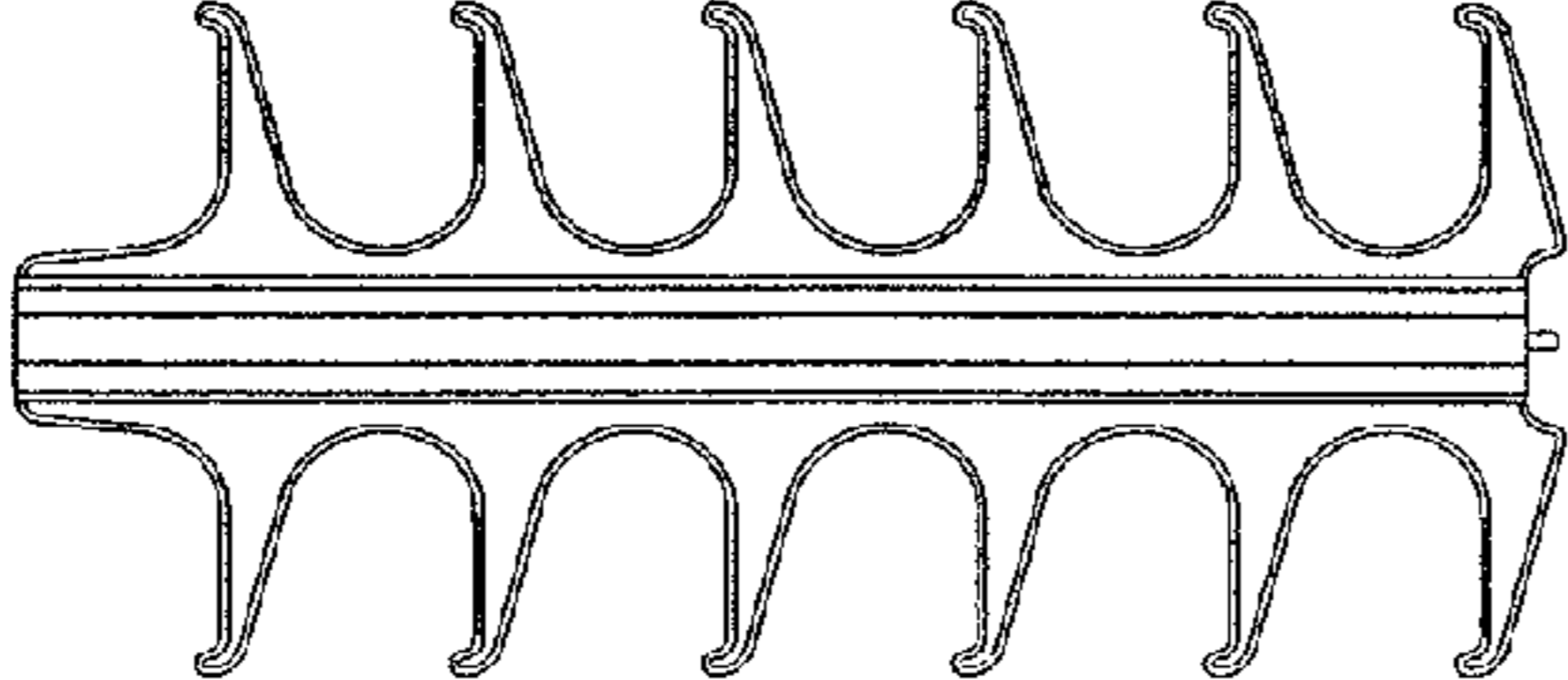

FIG. 6

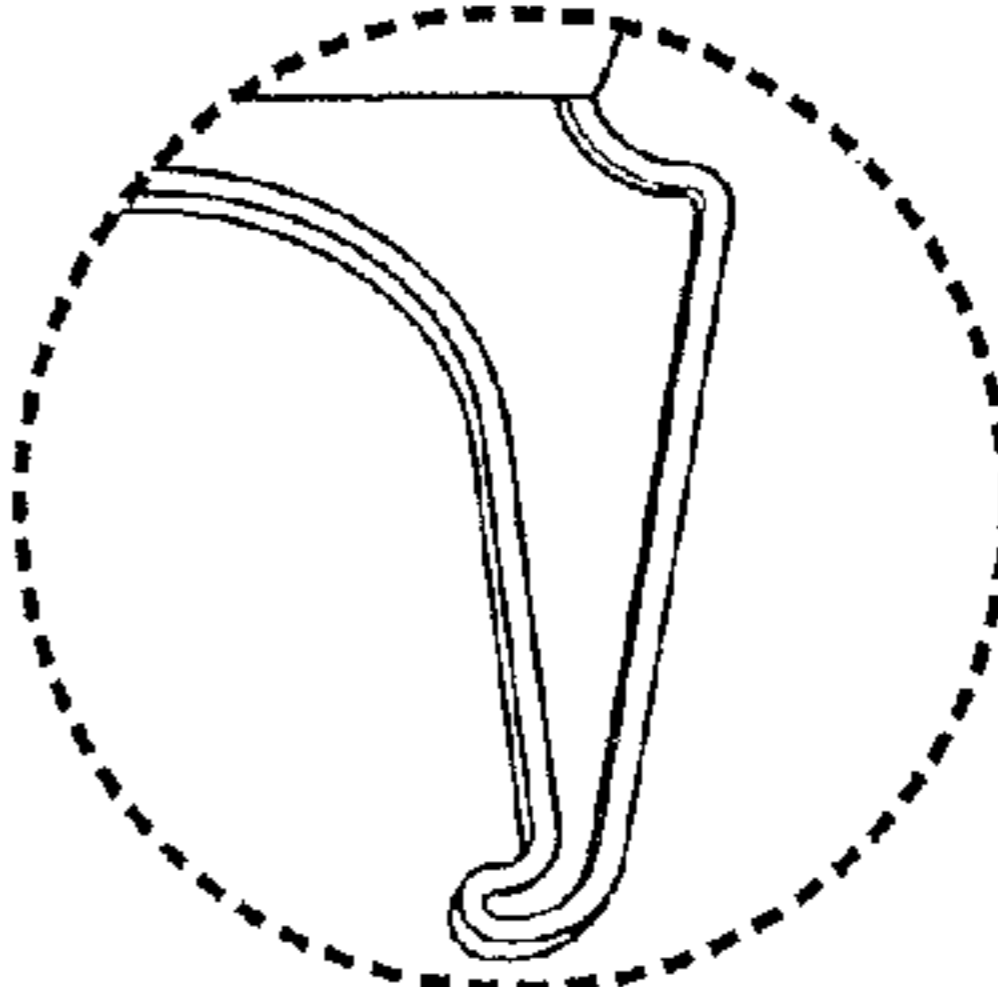

FIG. 9