



US00D605326S

(12) **United States Design Patent**
Sanoner

(10) **Patent No.:** **US D605,326 S**

(45) **Date of Patent:** **** Dec. 1, 2009**

(54) **SOLAR LIGHT**

(75) Inventor: **Hughes Marie Sanoner**, Discovery Bay (HK)

(73) Assignee: **Solar Wide Industrial Limited**, Tsuen Wan, New Territories, Hong Kong (CN)

(**) Term: **14 Years**

(21) Appl. No.: **29/314,505**

(22) Filed: **Apr. 6, 2009**

(30) **Foreign Application Priority Data**

Oct. 9, 2008 (EM) 001017834-0003

(51) **LOC (9) Cl.** **26-05**

(52) **U.S. Cl.** **D26/68**

(58) **Field of Classification Search** D26/67-71,
D26/73, 85; 362/152, 153, 153.1, 180, 183,
362/431, 653

See application file for complete search history.

(56) **References Cited**

U.S. PATENT DOCUMENTS

D218,985 S * 10/1970 Anderson, Jr. D26/67

5,055,984 A * 10/1991 Hung et al. 362/183

5,280,417 A * 1/1994 Hall et al. 362/153

D348,944 S * 7/1994 Shalvi D26/67
D374,497 S * 10/1996 Shalvi D26/68
D441,116 S * 4/2001 Sanoner D26/68
D454,406 S * 3/2002 Chang D26/67
D471,307 S * 3/2003 Yung D26/67
7,041,899 B2 * 5/2006 Stekelenburg 362/95
7,188,976 B1 * 3/2007 Fung 362/351
2004/0095772 A1 * 5/2004 Hoover et al. 362/431

* cited by examiner

Primary Examiner—Clare E Heflin

(74) *Attorney, Agent, or Firm*—Alix, Yale & Ristas, LLP

(57) **CLAIM**

The ornamental design for a solar light, as shown and described.

DESCRIPTION

FIG. 1 is a front, right side and top perspective view of a solar light showing my new design;

FIG. 2 is a right side and bottom perspective view thereof;

FIG. 3 is a front and bottom perspective view thereof;

FIG. 4 is a front elevational view thereof;

FIG. 5 is a right side elevational view thereof;

FIG. 6 is a top plan view thereof; and,

FIG. 7 is a bottom plan view thereof.

1 Claim, 3 Drawing Sheets

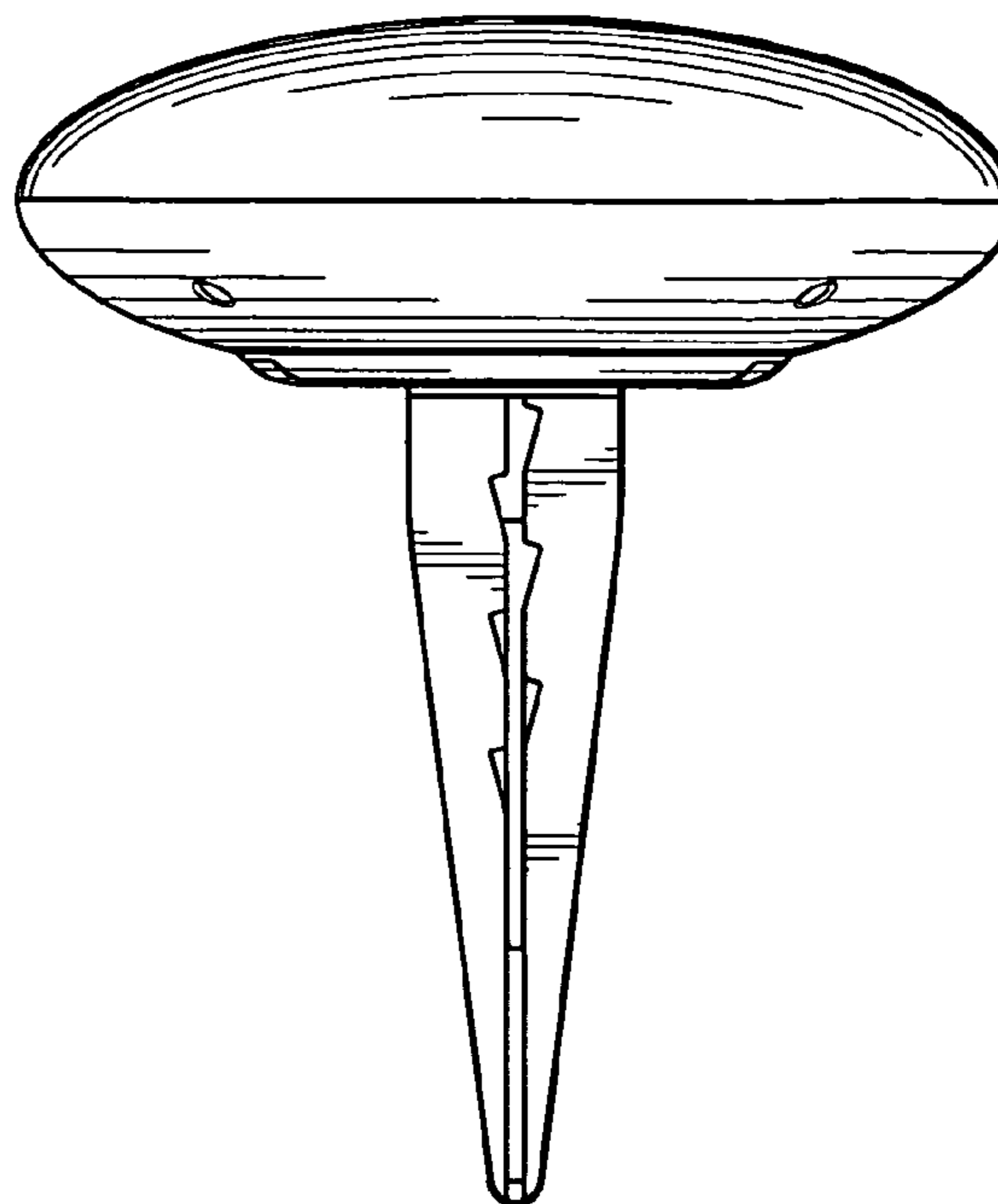
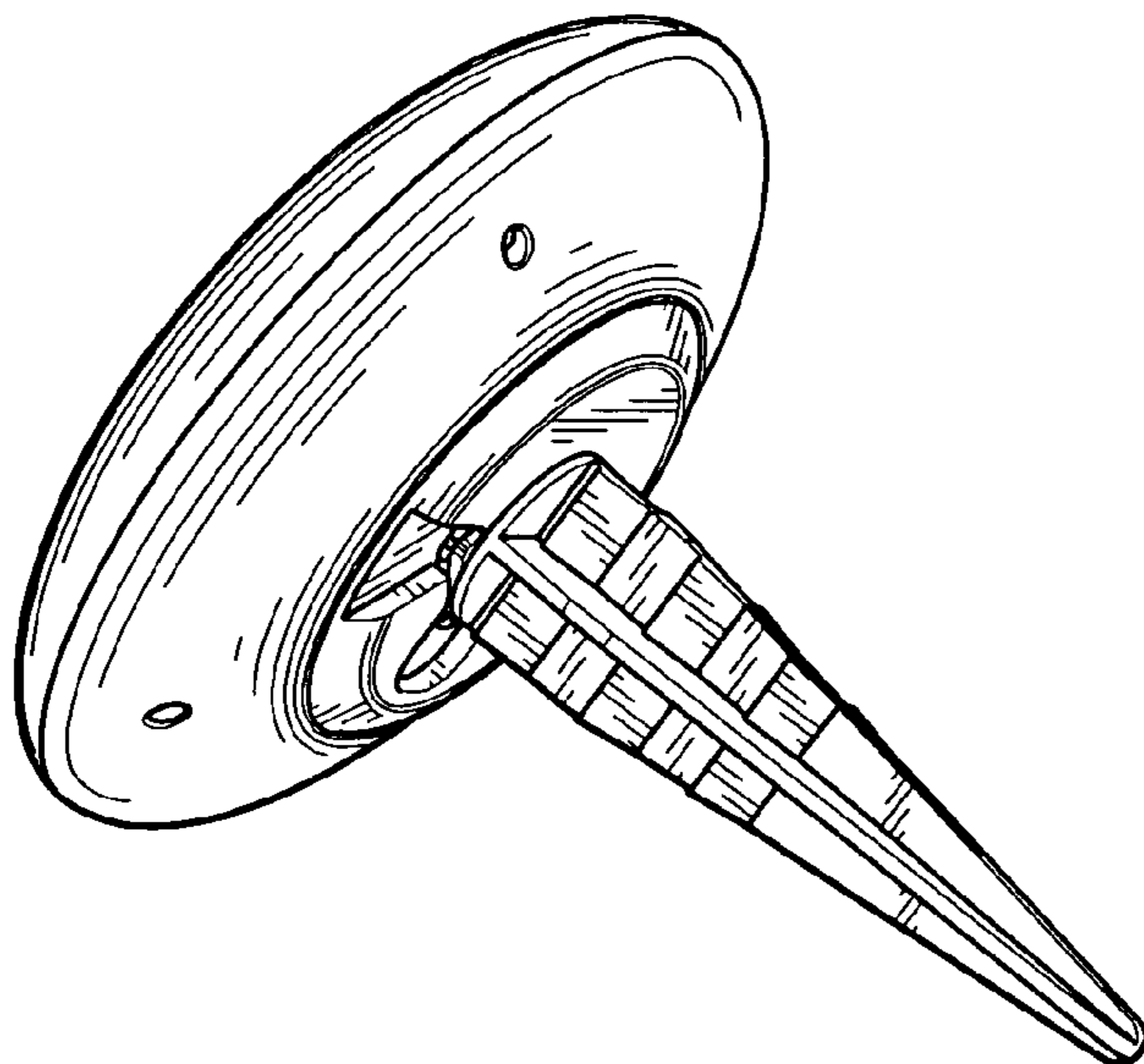

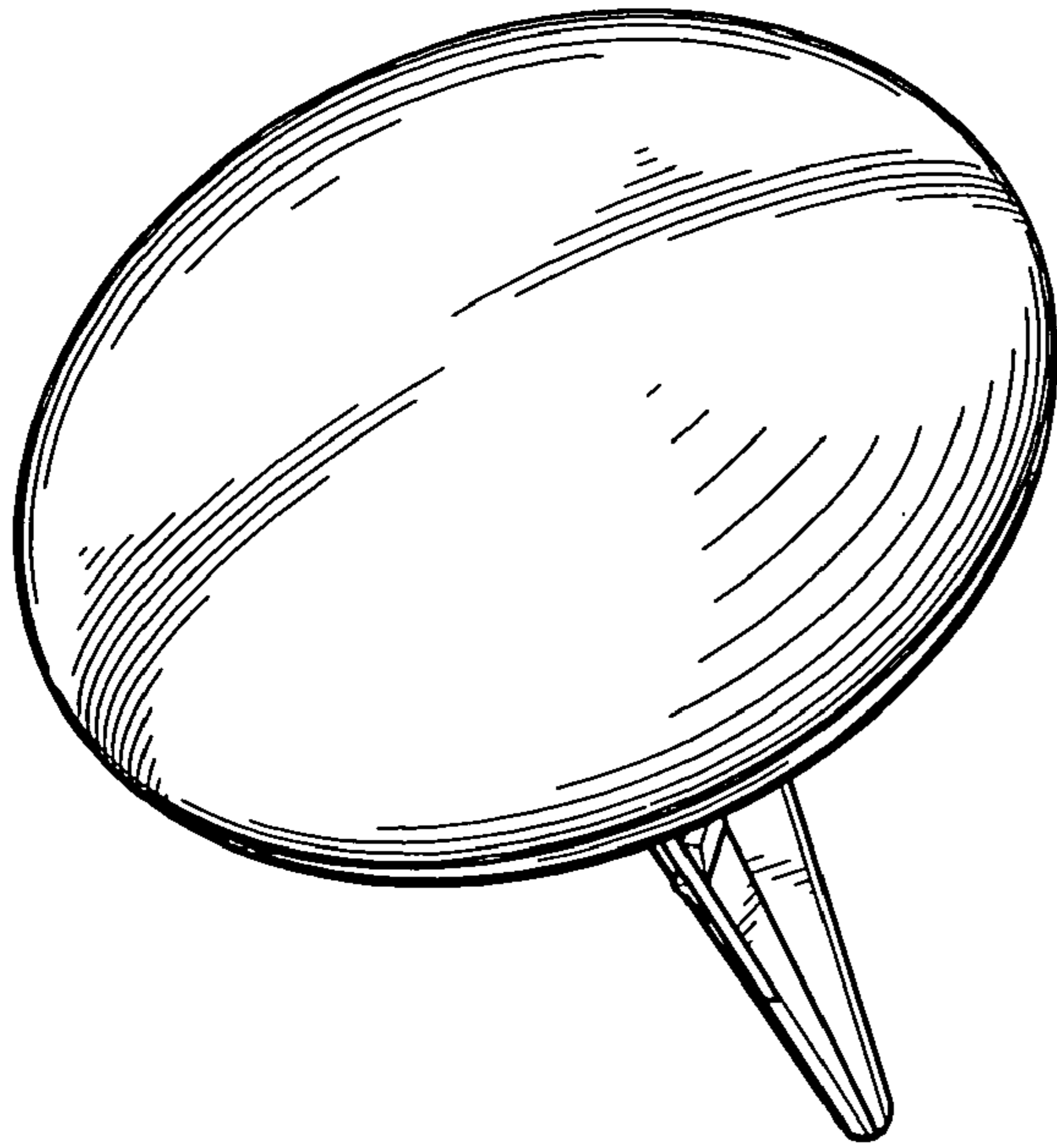

FIG. 1

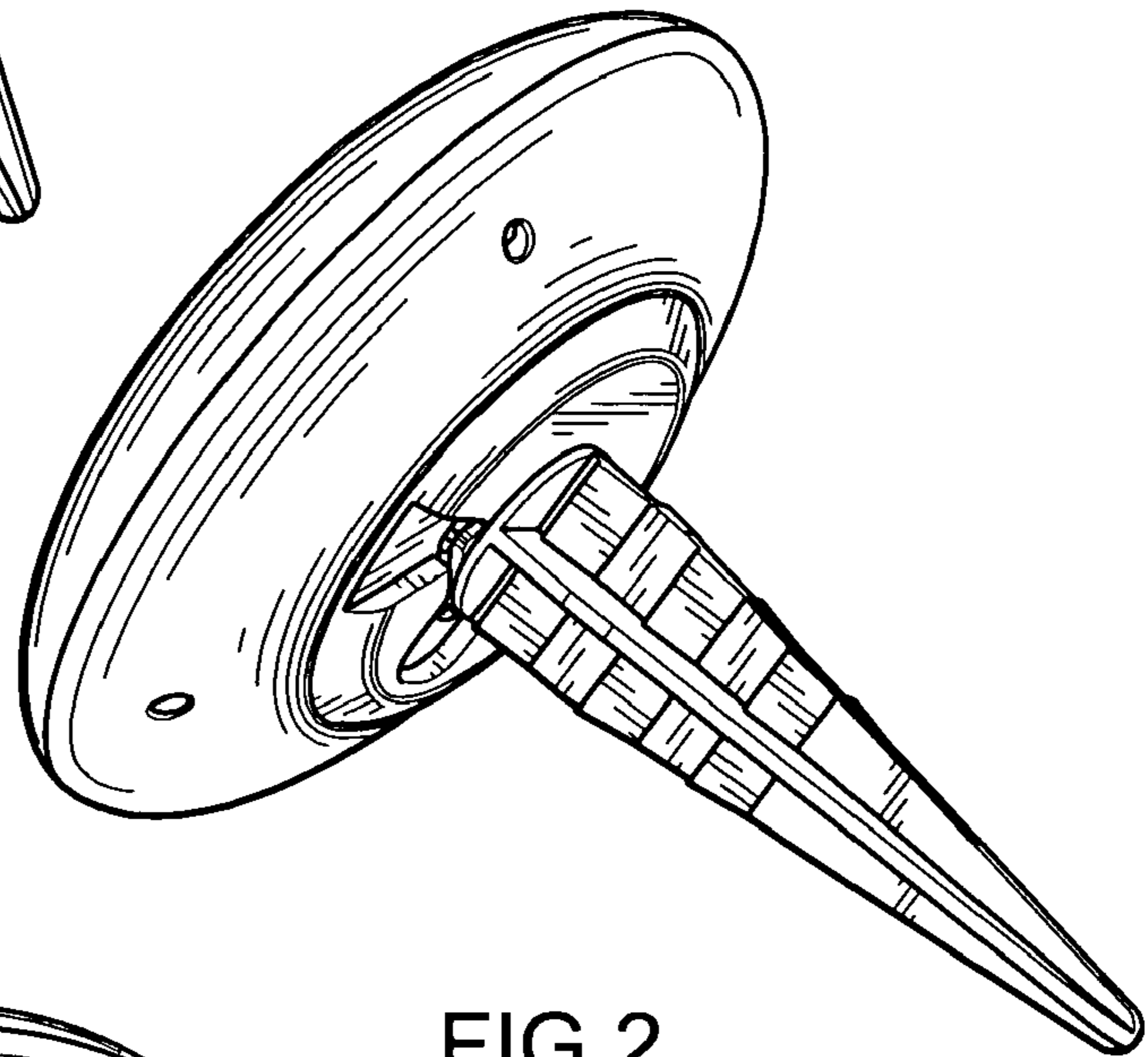

FIG. 2

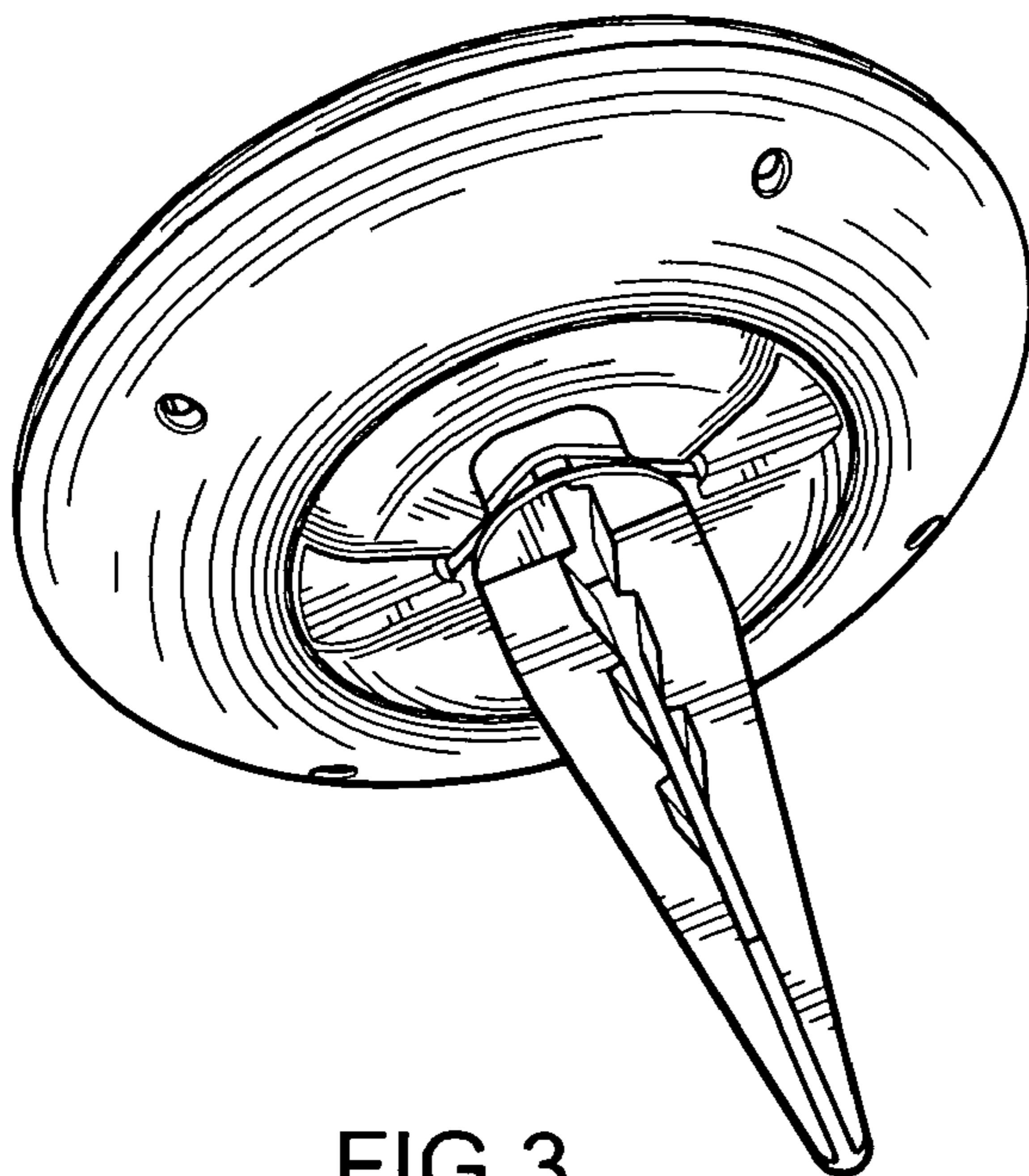

FIG. 3

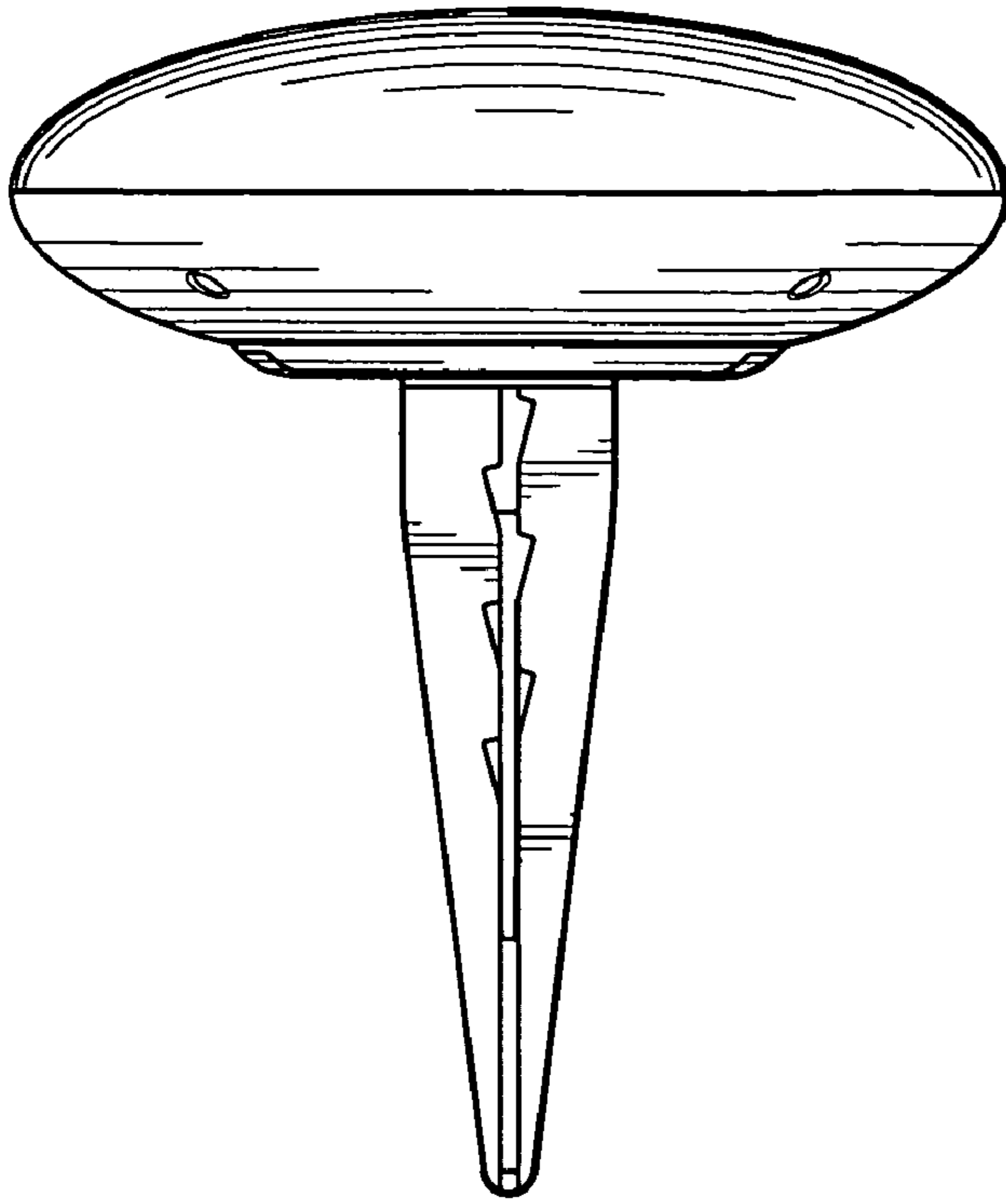

FIG. 4

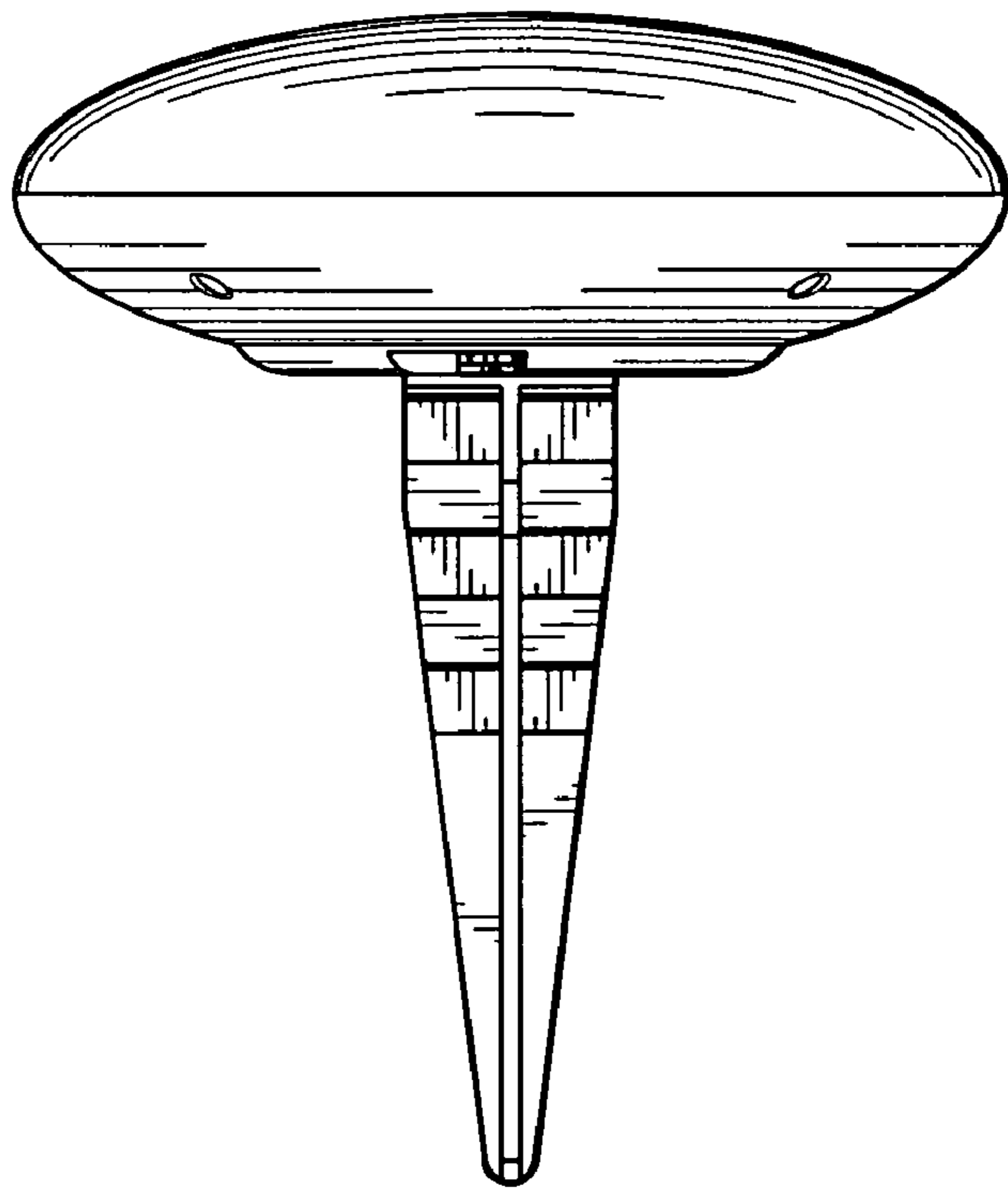

FIG. 5

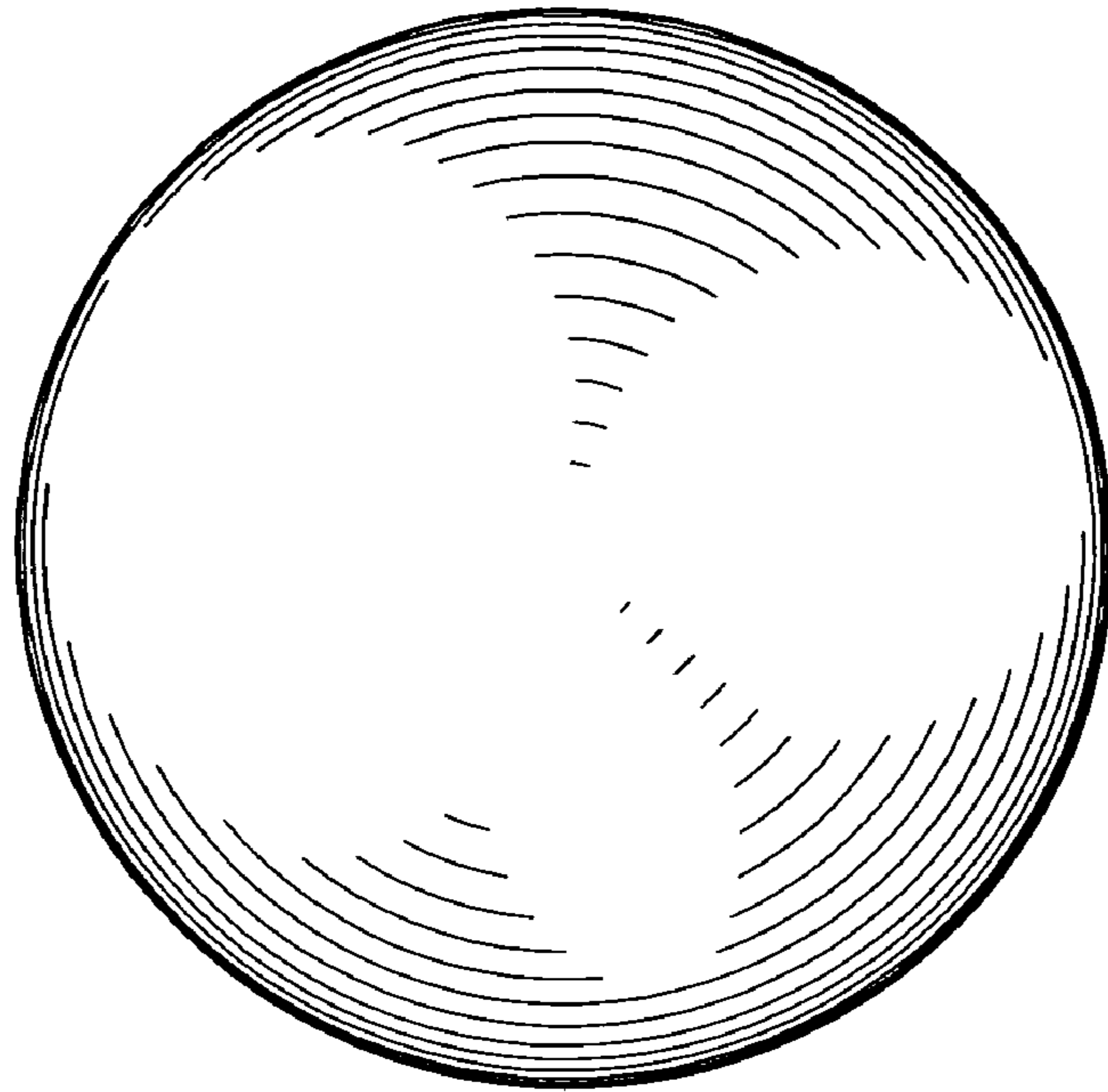

FIG. 6

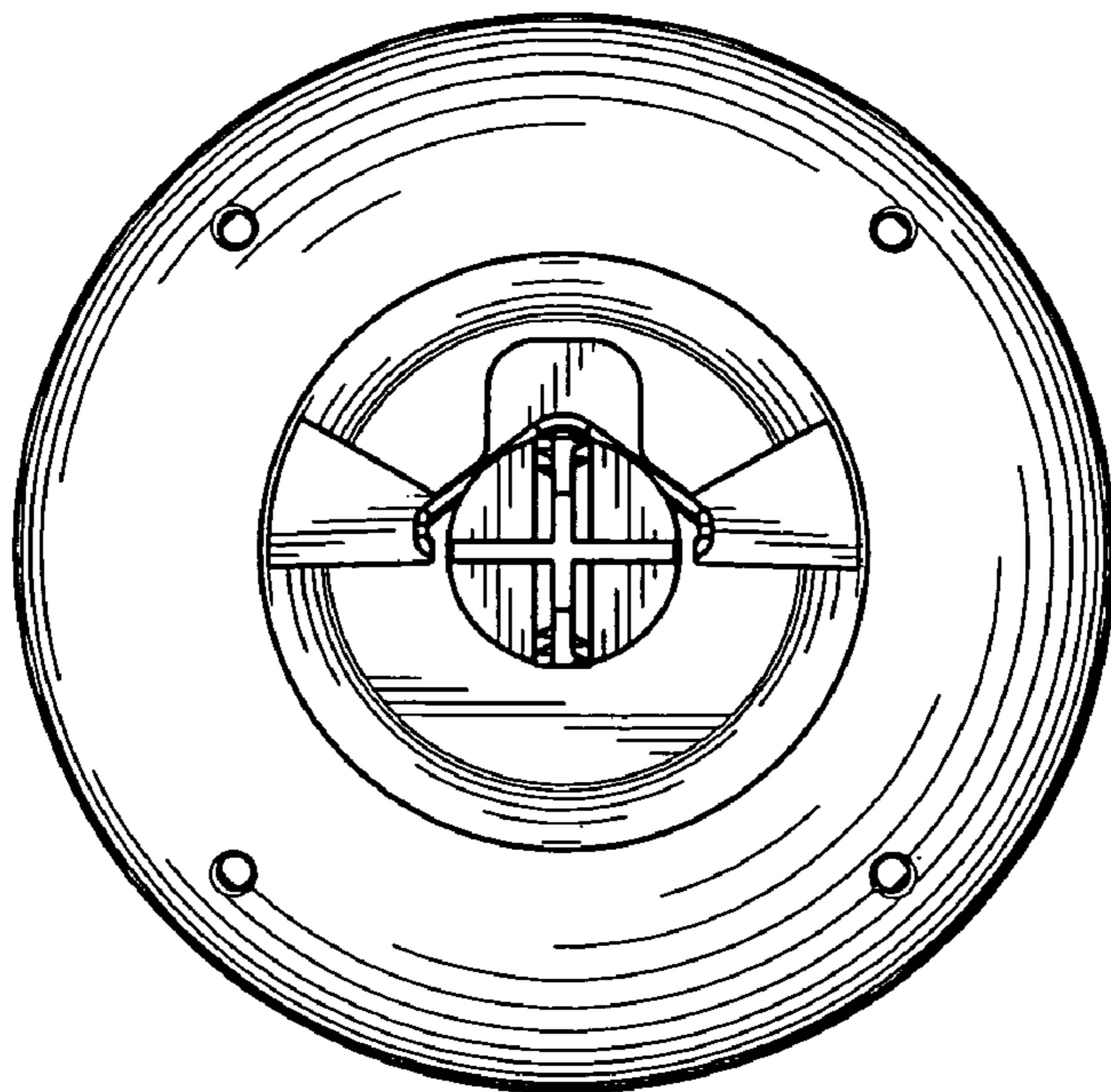

FIG. 7