



US00D605213S

(12) **United States Design Patent**
Liu et al.

(10) **Patent No.:** **US D605,213 S**
(45) **Date of Patent:** **** Dec. 1, 2009**

(54) **DIGITAL PHOTO FRAME WITH CAMERA**

(75) Inventors: **Menghua Liu**, Yantian District (CN);
Gang Liu, Yantian District (CN)

(73) Assignee: **Shenzhen Act Industrial Co., Ltd.**,
Yantian District (CN)

(**) Term: **14 Years**

(21) Appl. No.: **29/318,057**

(22) Filed: **May 12, 2008**

(51) **LOC (9) Cl.** **16-01**

(52) **U.S. Cl.** **D16/208**

(58) **Field of Classification Search** D16/200–206,
D16/208, 213, 218; D6/300, 308; 358/906;
396/427, 535–541; 348/143, 151, 373–376,
348/333.01, 333.11

See application file for complete search history.

(56) **References Cited**

U.S. PATENT DOCUMENTS

D392,110 S *	3/1998	Tsui	D6/309
D454,146 S *	3/2002	Mori	D16/202
D467,955 S *	12/2002	Backs et al.	D16/218
7,158,175 B2 *	1/2007	Belz et al.	348/231.3
7,170,557 B2 *	1/2007	Manico et al.	348/333.07
D544,010 S *	6/2007	Martin	D16/208
7,259,793 B2 *	8/2007	Manico et al.	348/373

2005/0122401 A1 *	6/2005	Horie	348/207.99
2005/0134726 A1 *	6/2005	Parulski et al.	348/373
2007/0285561 A1 *	12/2007	Chen	348/373
2008/0117323 A1 *	5/2008	Sakamoto et al.	348/333.01
2008/0225161 A1 *	9/2008	Tsai et al.	348/376
2009/0128502 A1 *	5/2009	Li et al.	345/173

* cited by examiner

Primary Examiner—Ian Simmons
Assistant Examiner—Wan Laymon

(57) **CLAIM**

The ornamental design for a digital photo frame with camera, as shown and described.

DESCRIPTION

FIG. 1 is a front elevational view of a digital photo frame with camera showing our new design;

FIG. 2 is a rear elevational view thereof;

FIG. 3 is a left side view thereof;

FIG. 4 is a right side view thereof;

FIG. 5 is a top plan view thereof;

FIG. 6 is a bottom plan view thereof; and,

FIG. 7 is a perspective view thereof.

The dotted lines shown in FIG. 7 are for illustrative purpose only and form no part of the claimed design.

1 Claim, 5 Drawing Sheets

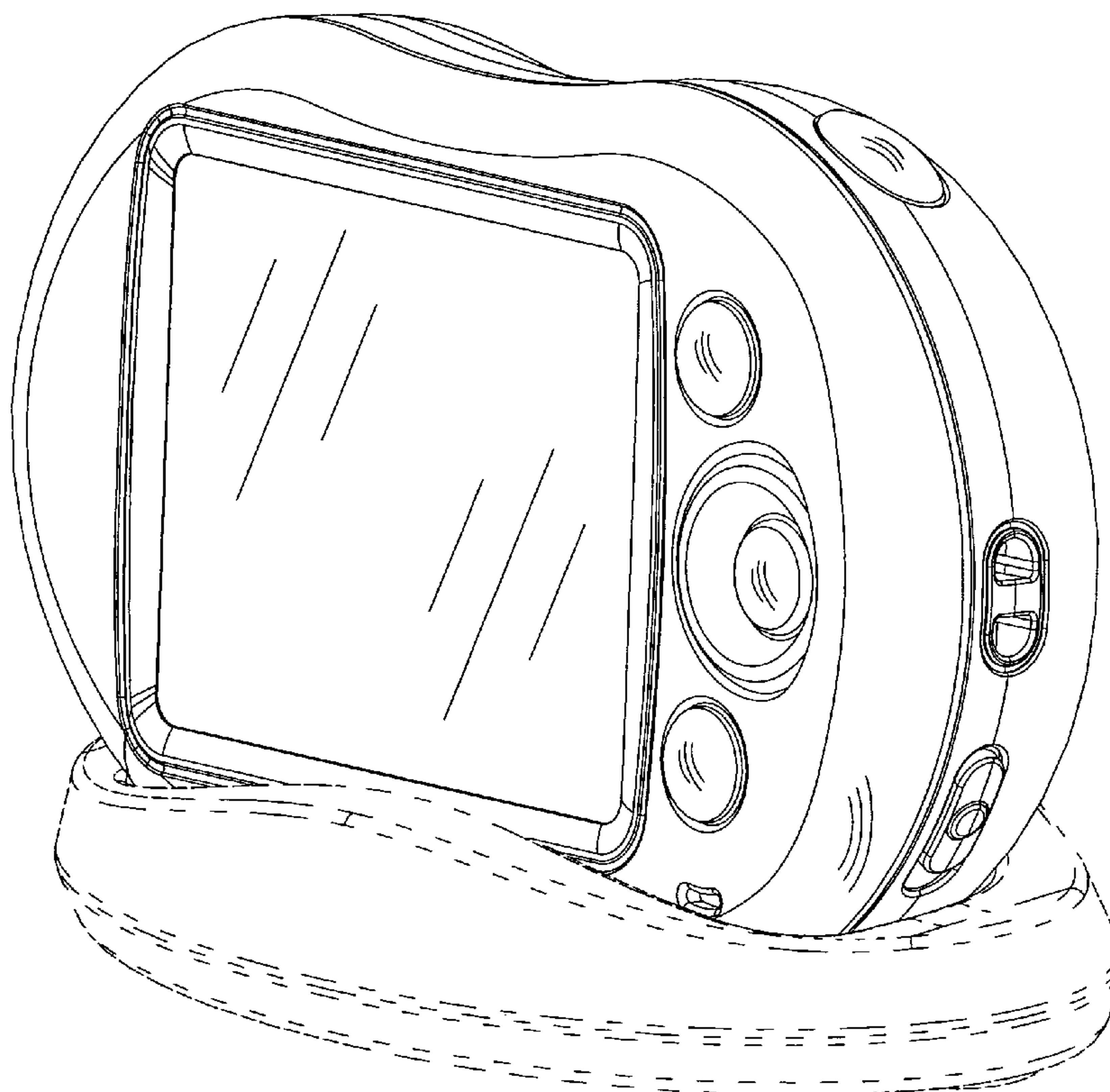

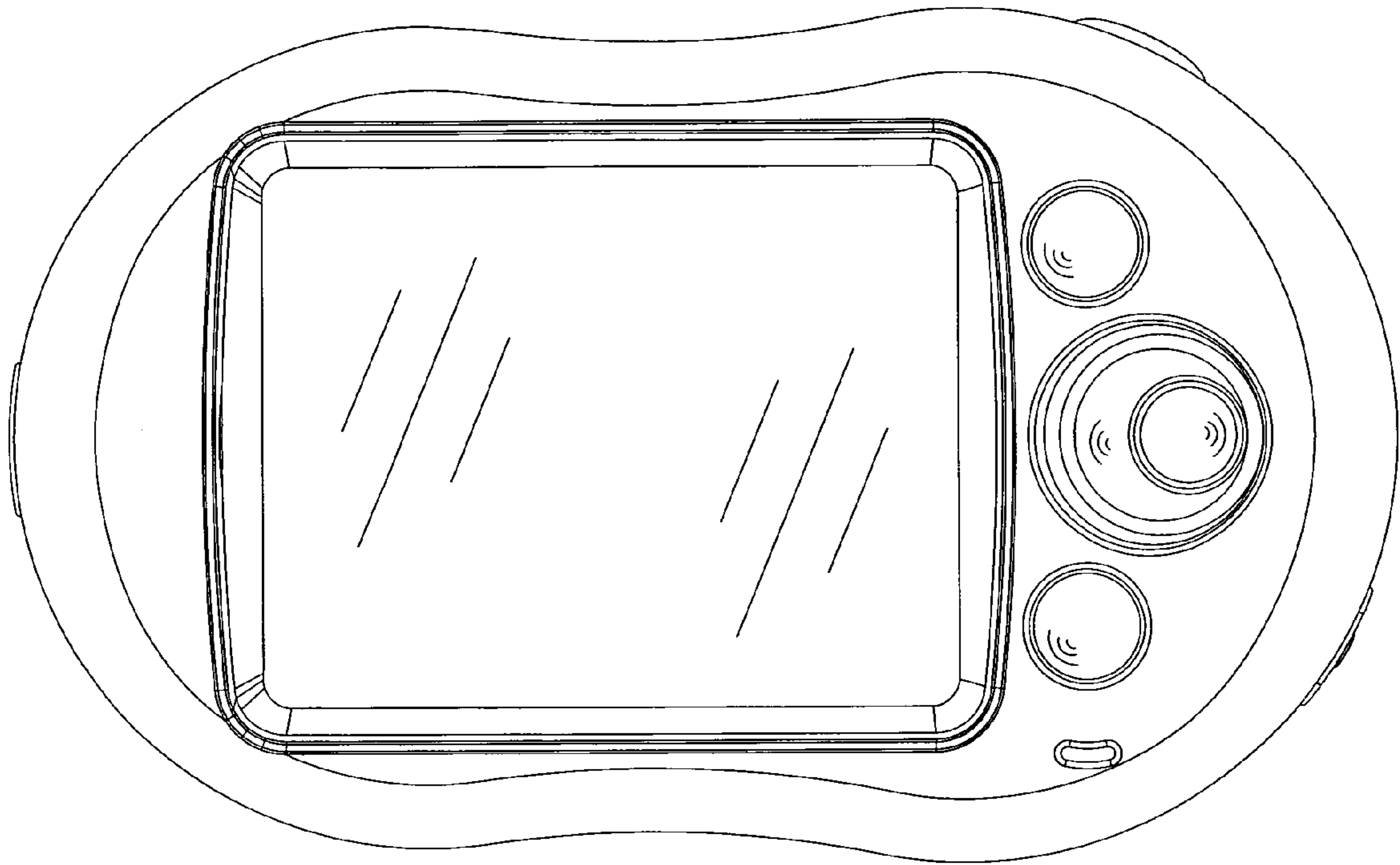

FIG. 1

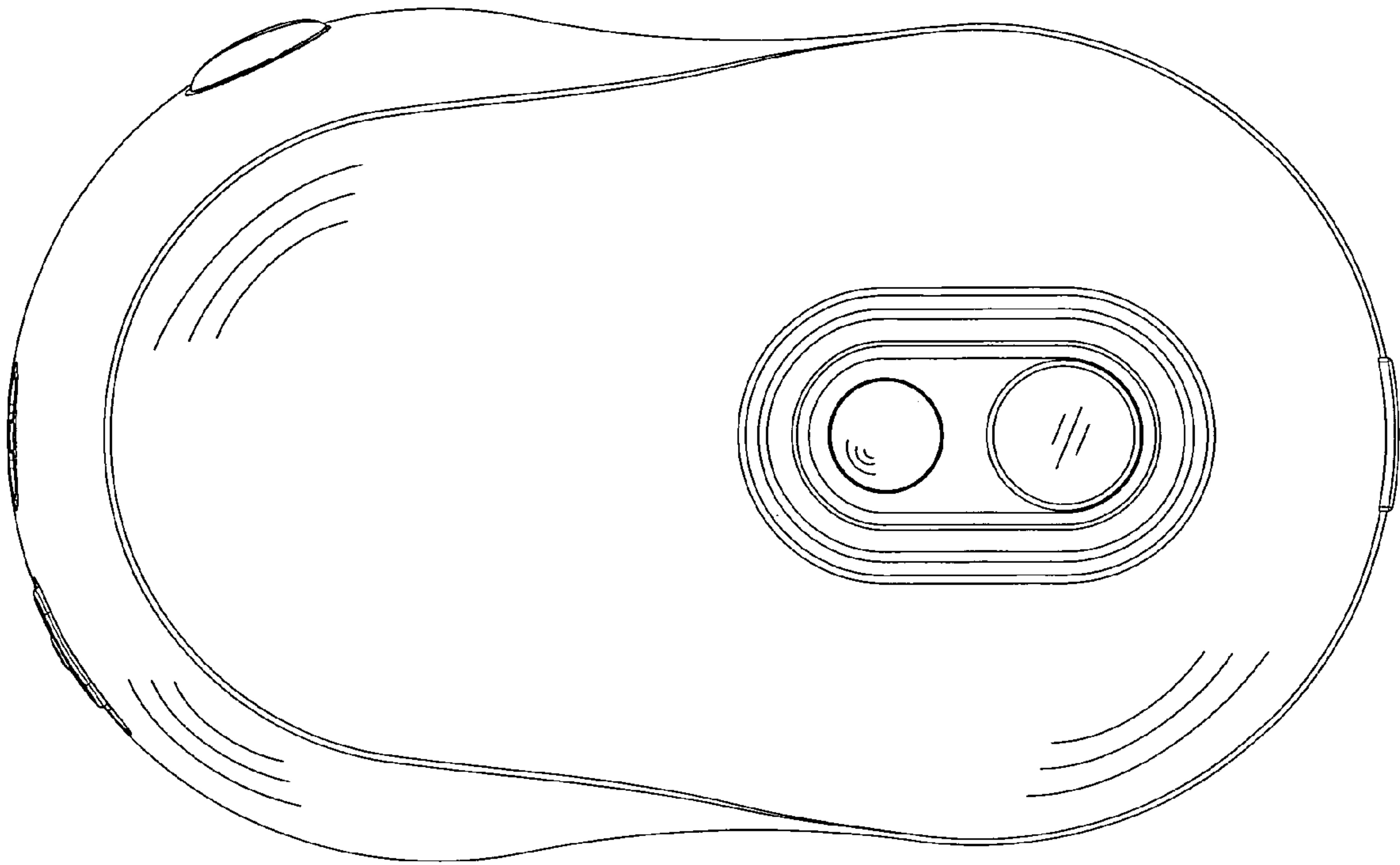

FIG. 2

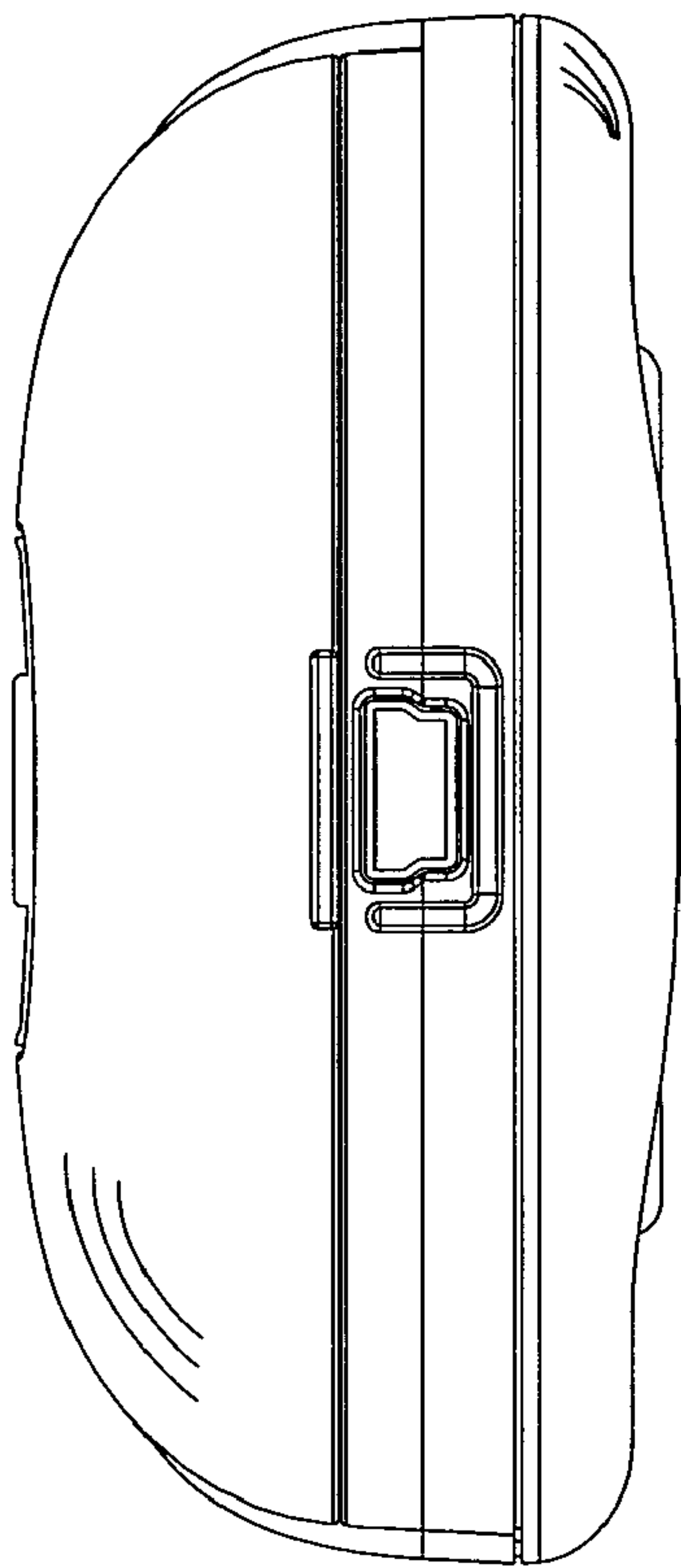

FIG. 3

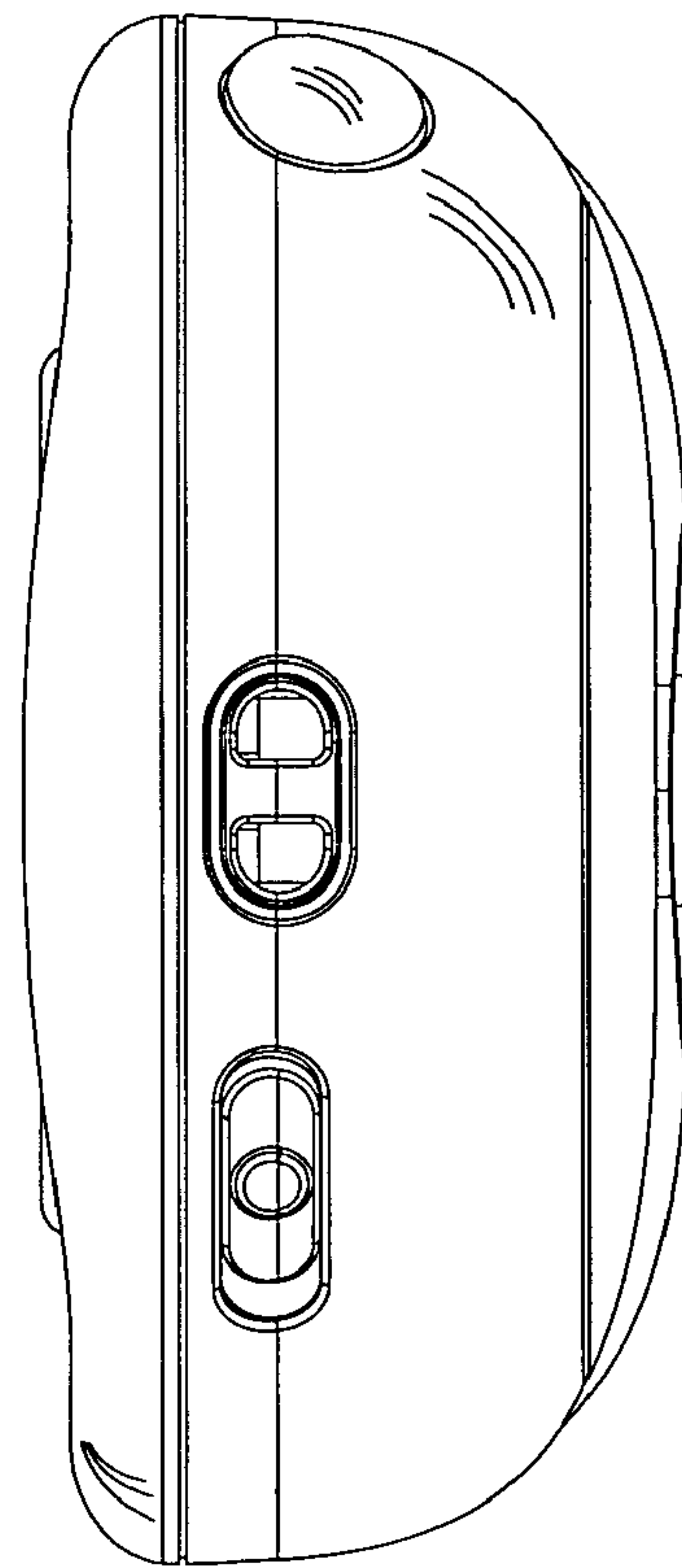

FIG. 4

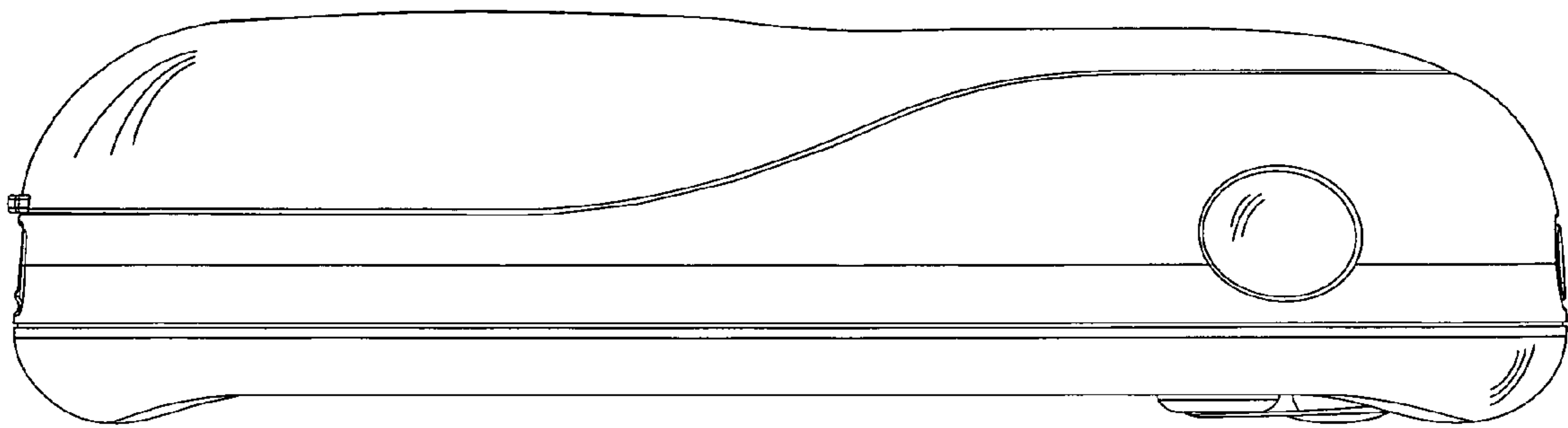

FIG. 5

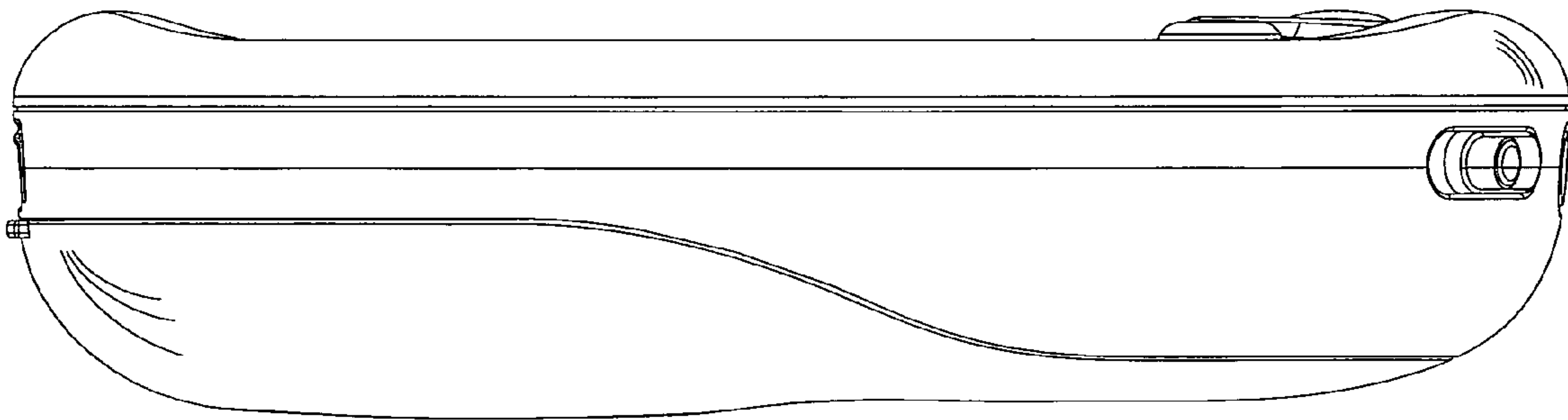

FIG. 6

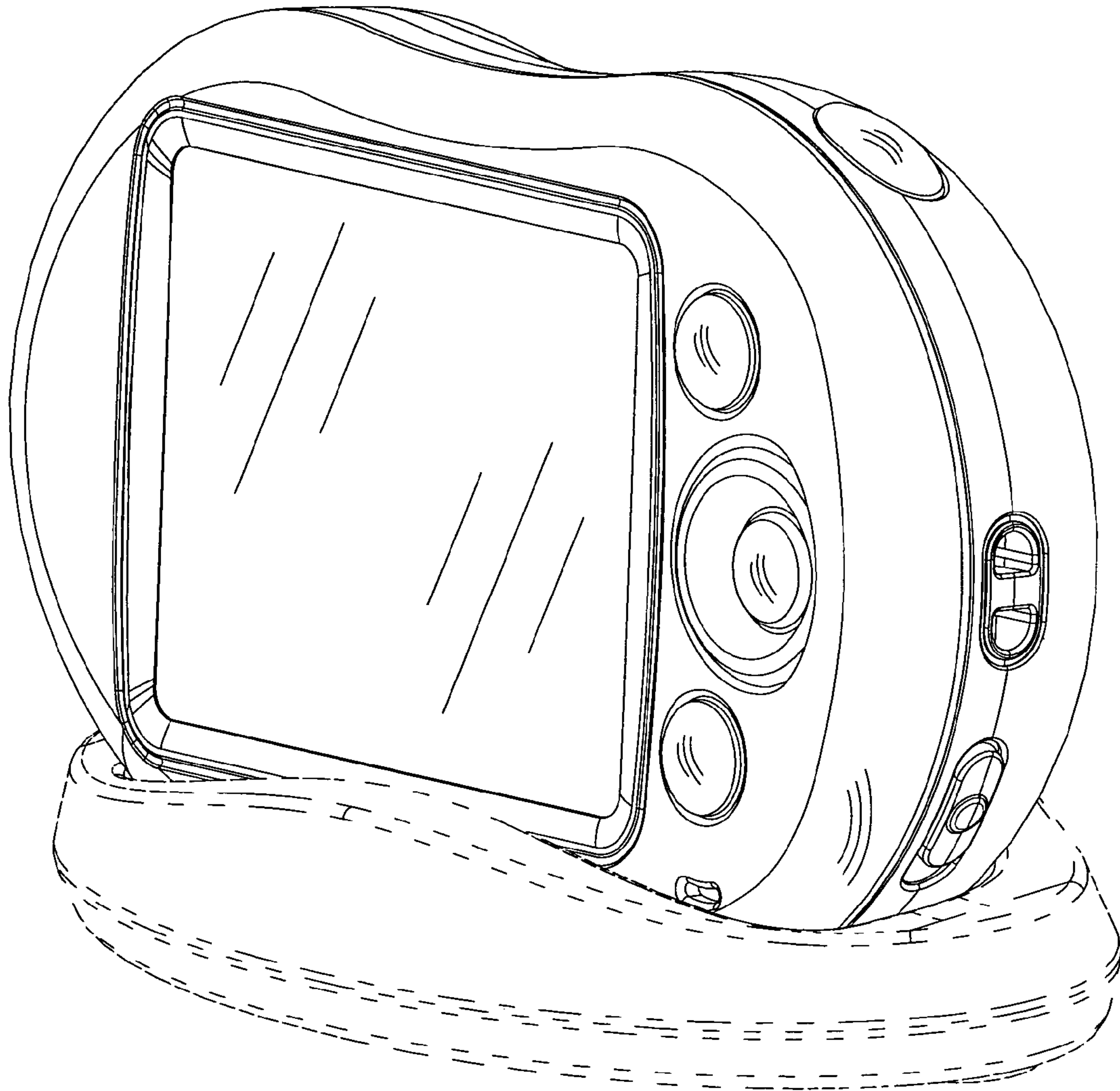

FIG. 7