



(12) **United States Design Patent**
Cha et al.

(10) **Patent No.:** **US D605,155 S**
(45) **Date of Patent:** **** Dec. 1, 2009**

(54) **MOBILE PHONE**

(75) Inventors: **Seong-Won Cha**, Seoul (KR);
Yoon-Young Cho, Seoul (KR);
Chang-Hwan Hwang, Goyang-si (KR)

(73) Assignee: **Samsung Electronics Co., Ltd**,
Suwon-Si (KR)

(**) Term: **14 Years**

(21) Appl. No.: **29/328,788**

(22) Filed: **Dec. 2, 2008**

(30) **Foreign Application Priority Data**

Oct. 17, 2008 (KR) 30-2008-0044741

(51) **LOC (9) Cl.** **14-03**

(52) **U.S. Cl.** **D14/138 AD**

(58) **Field of Classification Search** D14/138 R,
D14/138 AD, 138 AC, 138 C, 138 G, 191,
D14/203.1–203.8, 496, 138 AA, 138 AB,
D14/247–248, 137, 147, 218, 341–347; D10/65,
D10/78, 104; D13/168; D18/7; 455/566,
455/575.1, 575.3

See application file for complete search history.

(56) **References Cited**

U.S. PATENT DOCUMENTS

D498,754 S * 11/2004 Blyth D14/341
D509,760 S * 9/2005 Burrell et al. D10/65
D512,393 S * 12/2005 Lee et al. D14/138 AD
D526,222 S * 8/2006 Uehara D10/65
D527,000 S * 8/2006 Hong et al. D14/346
D527,717 S * 9/2006 Kim D14/138 AD
D527,718 S * 9/2006 Shin D14/138 AD
D528,090 S * 9/2006 Lee et al. D14/138 AD
D530,295 S * 10/2006 Chung et al. D14/138 AD
D533,531 S * 12/2006 Hyun et al. D14/138 AD
D537,063 S * 2/2007 Kim et al. D14/138 AD
D544,459 S * 6/2007 Wang D14/138 AD
D549,683 S * 8/2007 Cho et al. D14/138 AD
D560,199 S * 1/2008 Lee et al. D14/138 AD

D563,940 S * 3/2008 Van Den Nieuwenhuizen
et al. 455/566
D565,533 S * 4/2008 Kim et al. D14/138 AD
7,369,882 B2 * 5/2008 Hwang et al. 455/575.1
D570,320 S * 6/2008 Lee et al. D14/138 AD
D572,695 S * 7/2008 Tu D14/138 AD
D574,806 S * 8/2008 Lee et al. D14/138 AD
D580,403 S * 11/2008 Jung et al. D14/138 AD
D580,430 S * 11/2008 Wei D14/341
D582,382 S * 12/2008 Kim D14/138 AD
2006/0223596 A1 * 10/2006 Hur 455/575.4
2008/0004083 A1 * 1/2008 Ohki et al. 455/566
2008/0280651 A1 * 11/2008 Duarte 455/566

OTHER PUBLICATIONS

Alcatel OT-280, announced Mar. 2009, [online], [retrieved on Mar. 6, 2009]. Retrieved from Internet, <URL: <http://www.gsmarena.com>>.*

(Continued)

Primary Examiner—Jeffrey D Asch
Assistant Examiner—Bridget L Eland
(74) *Attorney, Agent, or Firm*—Staas & Halsey LLP

(57) **CLAIM**

The ornamental design for a mobile phone, as shown and described.

DESCRIPTION

FIG. 1 is a front perspective view of a mobile phone;
FIG. 2 is a front view of the mobile phone of FIG. 1;
FIG. 3 is a rear view of the mobile phone of FIG. 1;
FIG. 4 is a left-side view of the mobile phone of FIG. 1;
FIG. 5 is a right-side view of the mobile phone of FIG. 1;
FIG. 6 is a top plan view of the mobile phone of FIG. 1;
FIG. 7 is a bottom plan view of the mobile phone of FIG. 1;
and,
FIG. 8 is a front perspective open view of the mobile phone of FIG. 1.

1 Claim, 5 Drawing Sheets

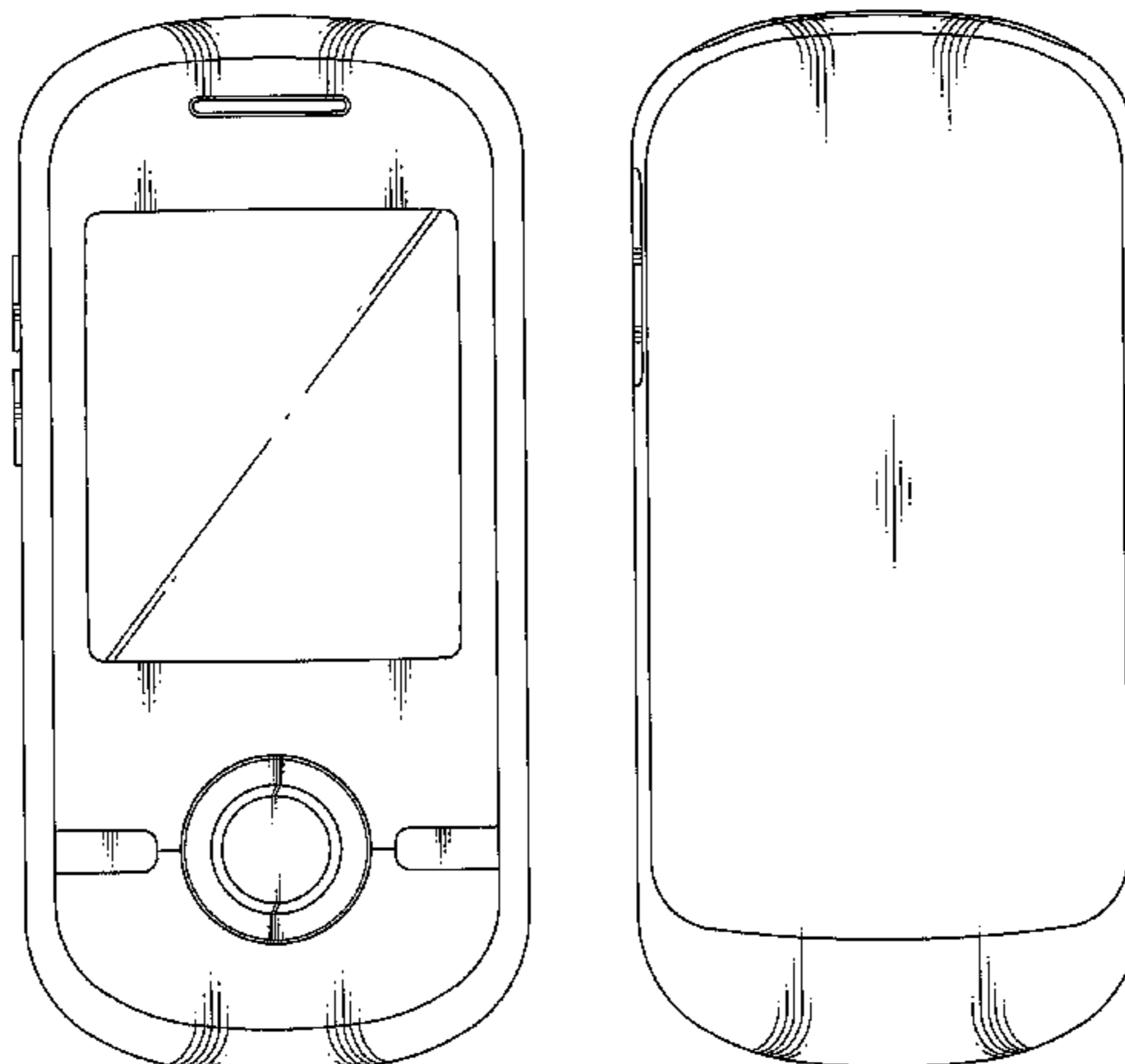

OTHER PUBLICATIONS

Gigabyte g-Smart MS820, announced Jun. 2008, [online], [retrieved on Jun. 13, 2008]. Retrieved from Internet, <URL: <http://www.gsmarena.com>>.*

Haier M80, announced 2nd quarter 2006, [online], [retrieved on Feb. 20, 2007]. Retrieved from Internet, <URL: <http://www.gsmarena.com>>.*

HTC P3600i, announced Aug. 2007, [online], [retrieved on Dec. 13, 2007]. Retrieved from Internet, <URL: <http://www.gsmarena.com>>.*

Motorola E680, announced 1st quarter 2004, [online], [retrieved on Feb. 16, 2007]. Retrieved from Internet, <URL: <http://www.gsmarena.com>>.*

Motorola A810, announced Jun. 2008, [online], [retrieved on Jun. 27, 2008]. Retrieved from Internet, <URL: <http://www.gsmarena.com>>.*

Motorola VE75, announced Jul. 2008, [online], [retrieved on Aug. 15, 2008]. Retrieved from Internet, <URL: <http://www.gsmarena.com>>.*

* cited by examiner

FIG. 1

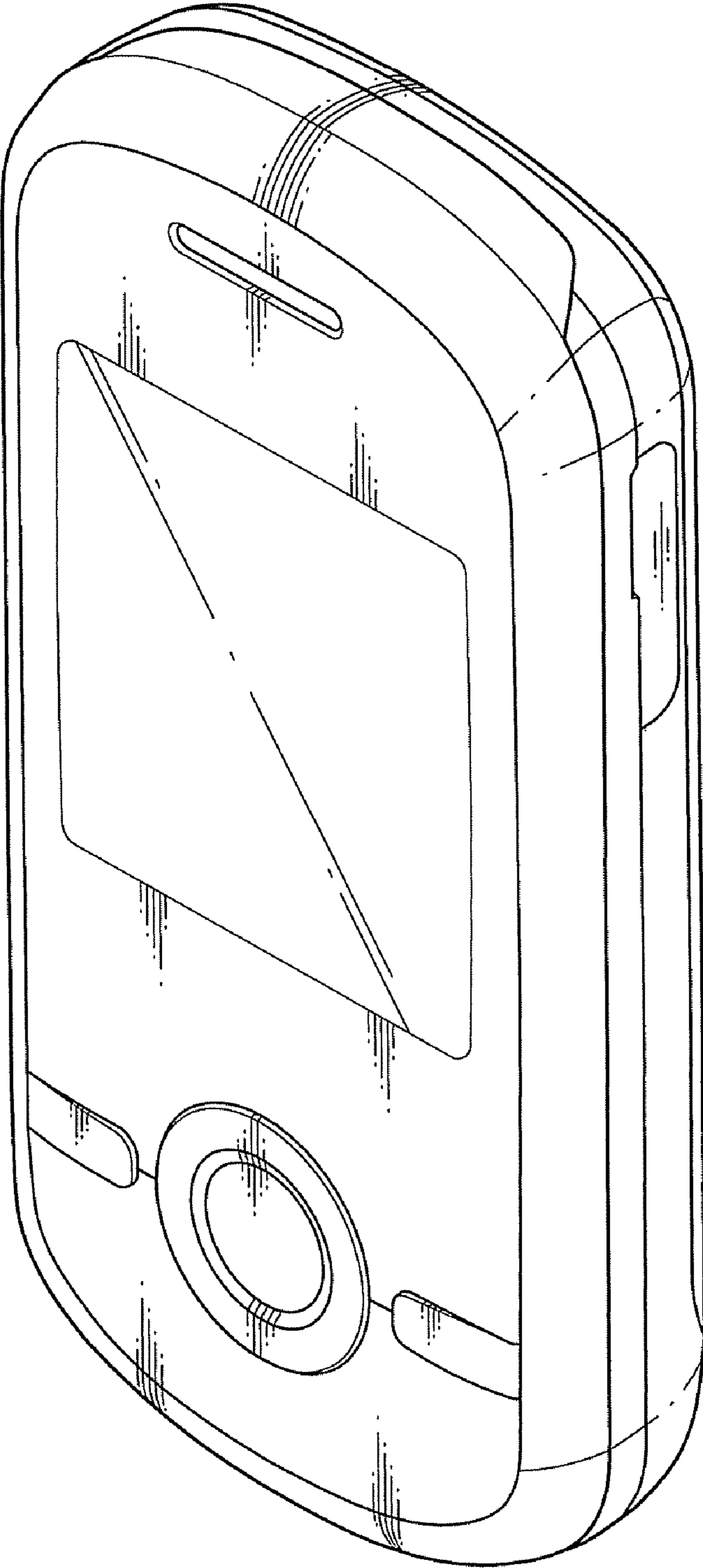

FIG.2

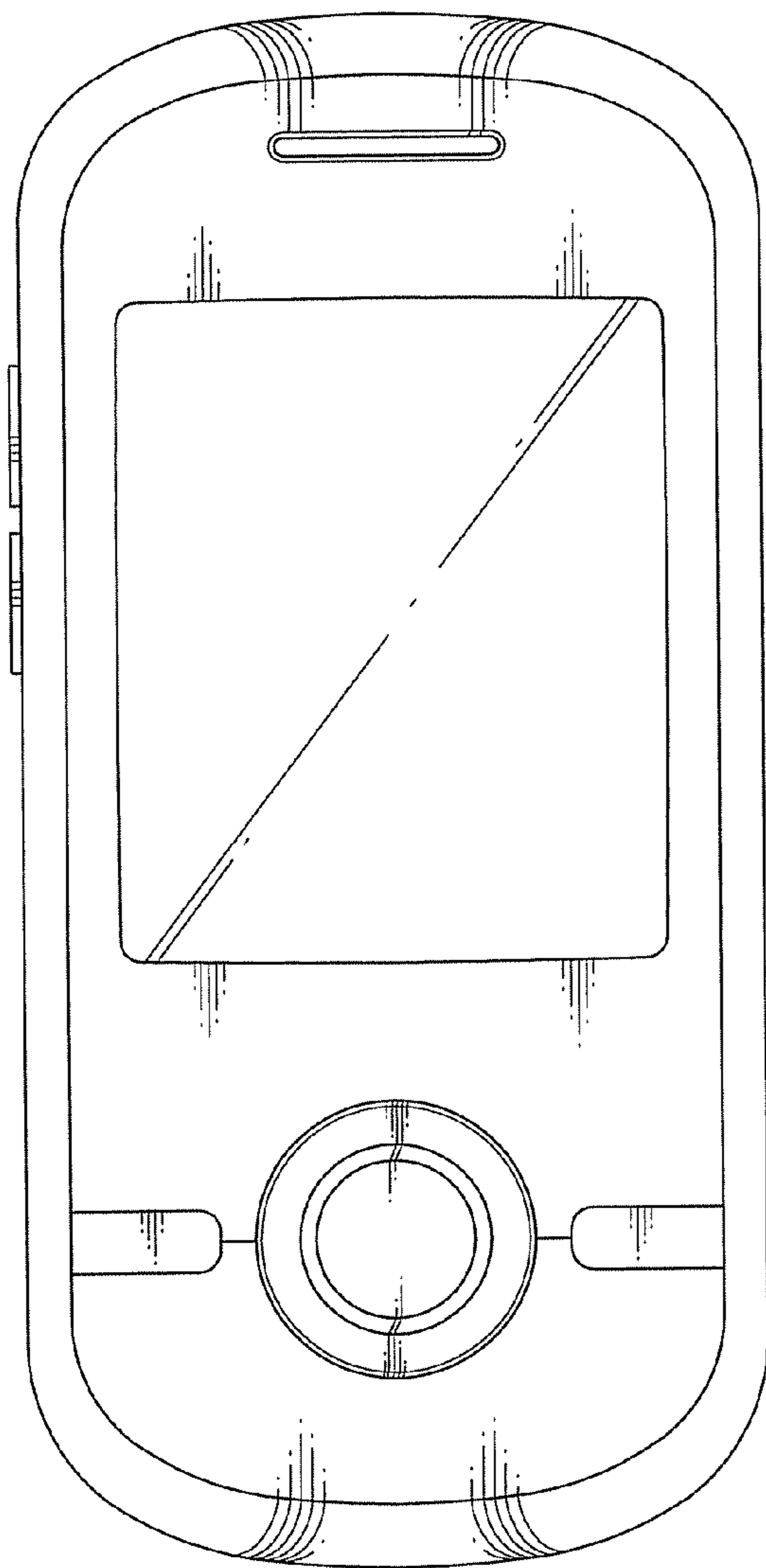

FIG.3

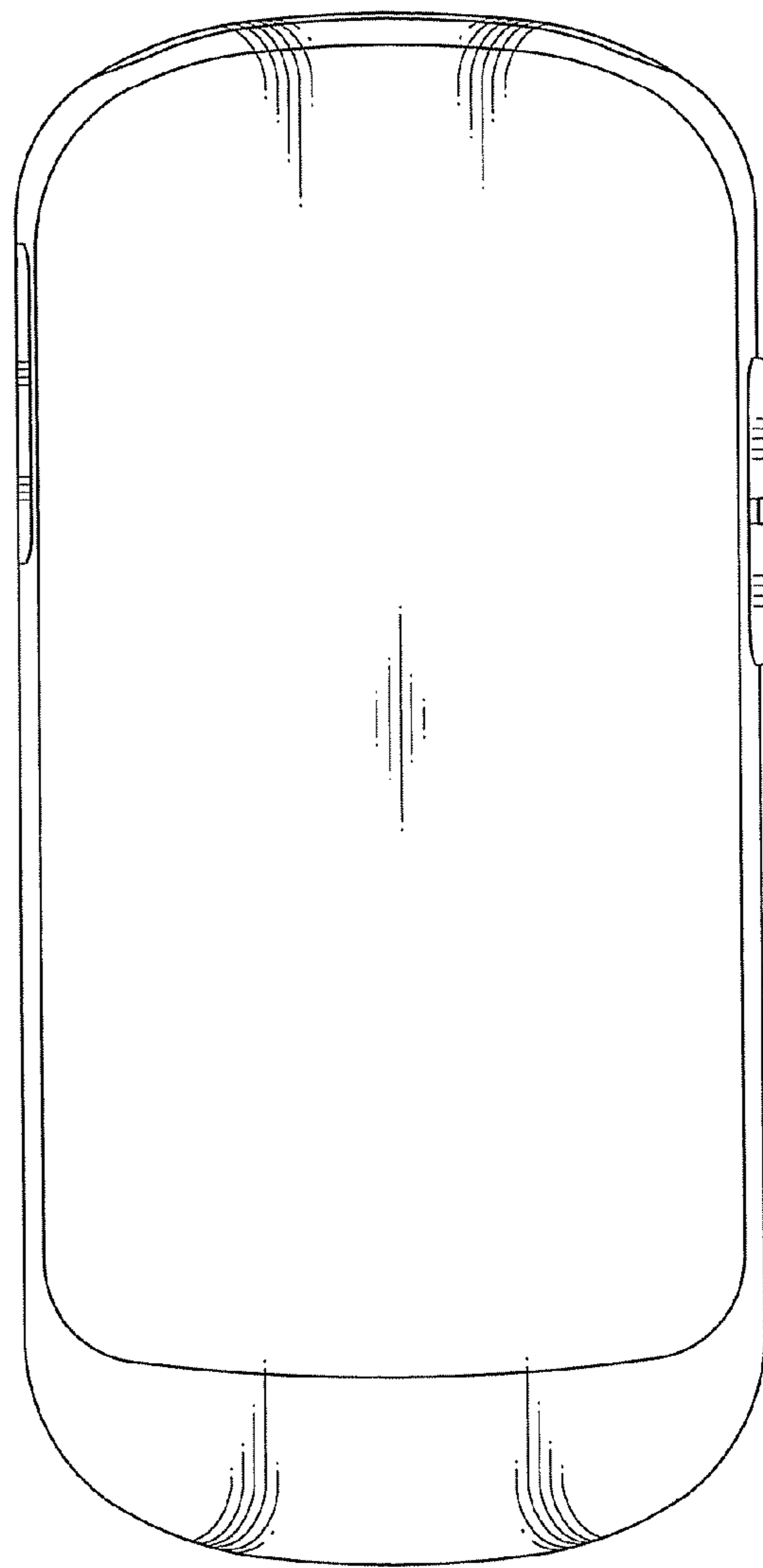

FIG. 4

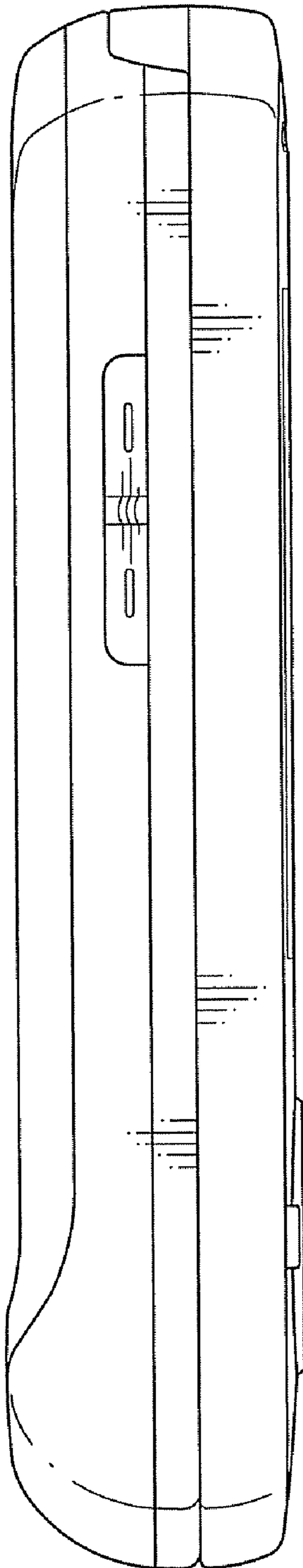

FIG. 5

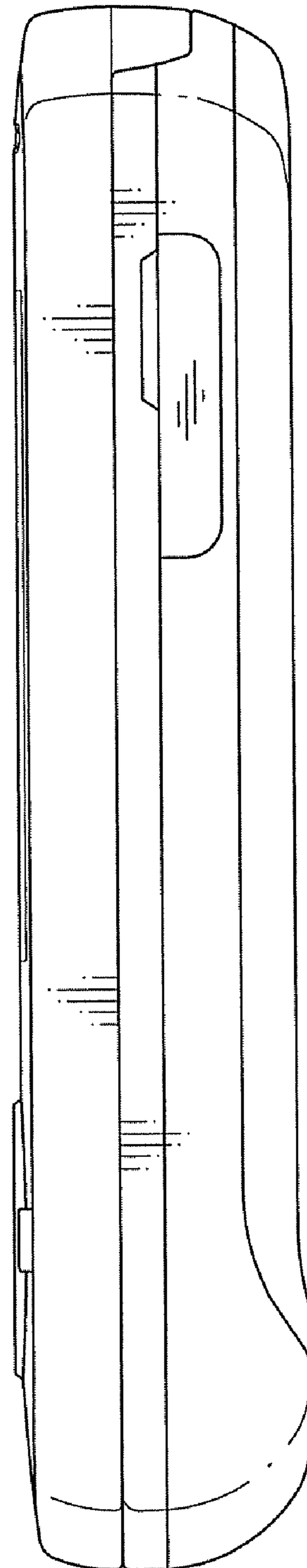

FIG. 6

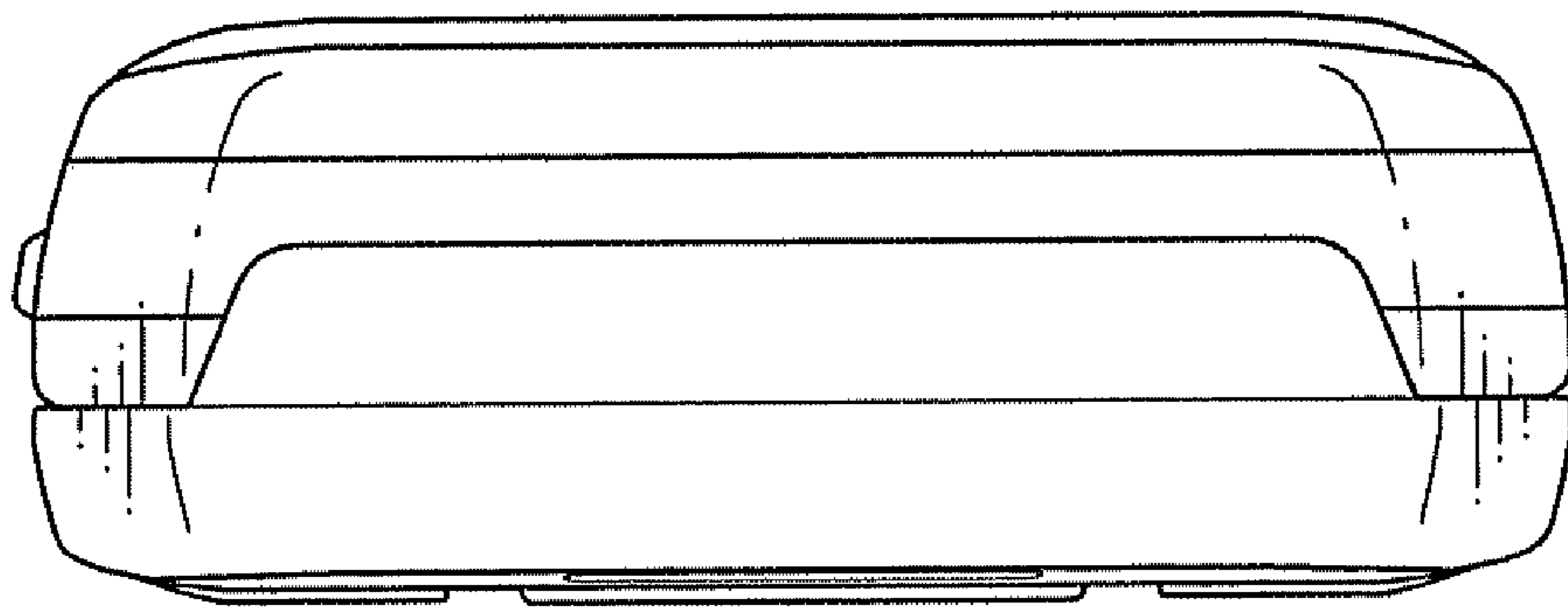

FIG. 7

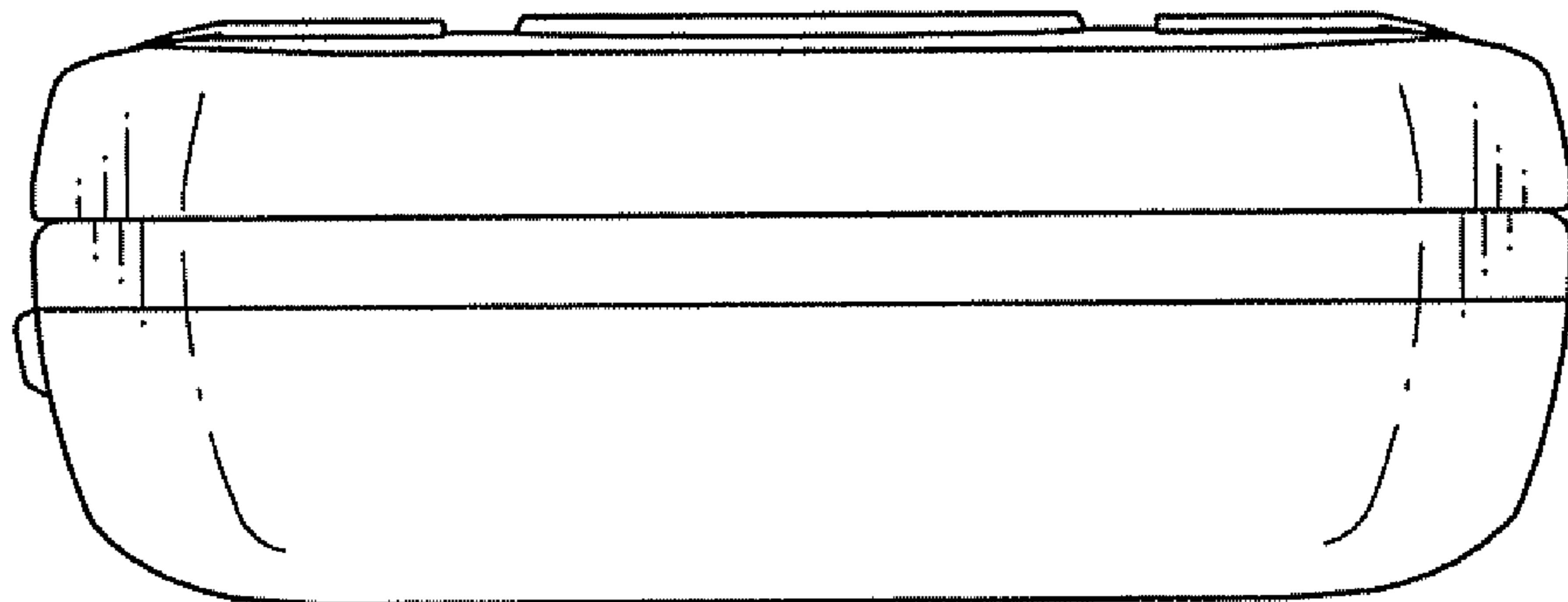

FIG. 8

