



US00D605154S

(12) **United States Design Patent**
Tkachuk

(10) **Patent No.:** **US D605,154 S**
(45) **Date of Patent:** **** Dec. 1, 2009**

(54) **MOBILE PHONE**

(75) Inventor: **Steven Tkachuk**, Los Angeles, CA (US)

(73) Assignee: **Samsung Electronics Co., Ltd**,
Suwon-Si (KR)

(**) Term: **14 Years**

(21) Appl. No.: **29/328,786**

(22) Filed: **Dec. 2, 2008**

(30) **Foreign Application Priority Data**

Aug. 27, 2008 (KR) 30-2008-0037093

(51) **LOC (9) Cl.** **14-03**

(52) **U.S. Cl.** **D14/138 AD**

(58) **Field of Classification Search** D14/138 R,
D14/138 AD, 138 AC, 138 C, 138 G, 191,
D14/203.1–203.8, 496, 138 AA, 138 AB,
D14/247–248, 137, 147, 218, 341–347; D10/65,
D10/78, 104; D13/168; D18/7; 455/566,
455/575.1, 575.3

See application file for complete search history.

(56) **References Cited**

U.S. PATENT DOCUMENTS

- D495,695 S * 9/2004 Yugaya D14/346
- D526,301 S * 8/2006 Shin D14/138 AD
- D528,094 S * 9/2006 Hwang D14/138 AD
- D529,474 S * 10/2006 Park et al. D14/138 AD
- D530,297 S * 10/2006 Moon et al. D14/138 G
- D531,608 S * 11/2006 Kim et al. D14/138 AD
- D548,214 S * 8/2007 Kim et al. D14/138 AD
- D548,715 S * 8/2007 Lee et al. D14/138 AD
- D551,201 S * 9/2007 Kim et al. D14/138 AD
- D553,115 S * 10/2007 Suk et al. D14/138 AD
- D554,096 S * 10/2007 Cho et al. D14/138 AD
- 7,283,697 B1 * 10/2007 Morikuni et al. 385/14
- D557,245 S * 12/2007 Kim et al. D14/138 AD
- D558,789 S * 1/2008 Yu et al. D14/496
- D567,795 S * 4/2008 Cha et al. D14/138 G
- 7,369,882 B2 * 5/2008 Hwang et al. 455/575.1
- D570,321 S * 6/2008 Choi et al. D14/138 AD
- D570,815 S * 6/2008 Son et al. D14/138 AD
- D572,699 S * 7/2008 Ahn et al. D14/138 G
- D575,760 S * 8/2008 Kim et al. D14/138 G

- D580,394 S * 11/2008 Kim et al. D14/138 G
- D584,738 S * 1/2009 Kim et al. D14/496
- D587,671 S * 3/2009 Park et al. D14/138 AD
- D589,483 S * 3/2009 Tkachuk D14/138 AD
- 2005/0255897 A1 * 11/2005 Lee et al. 455/575.4
- 2008/0316066 A1 * 12/2008 Minato et al. 341/24

OTHER PUBLICATIONS

Eten glofish DX900, announced Jun. 2008, [online], [retrieved on Jun. 13, 2008]. Retrieved from Internet, <URL: <http://www.gsmarena.com>>.*

Huawei U7310, announced 2nd quarter 2008, [online], [retrieved on Feb. 20, 2009]. Retrieved from Internet, <URL: <http://www.gsmarena.com>>.*

LG KS10, announced Feb. 2007, [online], [retrieved on Feb. 20, 2007]. Retrieved from Internet, <URL: <http://www.gsmarena.com>>.*

Samsung G800, announced Oct. 2007, [online], [retrieved on Dec. 13, 2007]. Retrieved from Internet, <URL: <http://www.gsmarena.com>>.*

Samsung P960, announced Feb. 2008, [online], [retrieved on Mar. 21, 2008]. Retrieved from Internet, <URL: <http://www.gsmarena.com>>.*

* cited by examiner

Primary Examiner—Jeffrey D Asch

Assistant Examiner—Bridget L Eland

(74) *Attorney, Agent, or Firm*—Staas & Halsey LLP

(57) **CLAIM**

The ornamental design for a mobile phone, as shown and described.

DESCRIPTION

FIG. 1 is a front perspective view of a mobile phone;
FIG. 2 is a front view of the mobile phone of FIG. 1;
FIG. 3 is a rear view of the mobile phone of FIG. 1;
FIG. 4 is a left-side view of the mobile phone of FIG. 1;
FIG. 5 is a right-side view of the mobile phone of FIG. 1;
FIG. 6 is a top plan view of the mobile phone of FIG. 1;
FIG. 7 is a bottom plan view of the mobile phone of FIG. 1;
and,
FIG. 8 is a front open view of the mobile phone of FIG. 1.

1 Claim, 5 Drawing Sheets

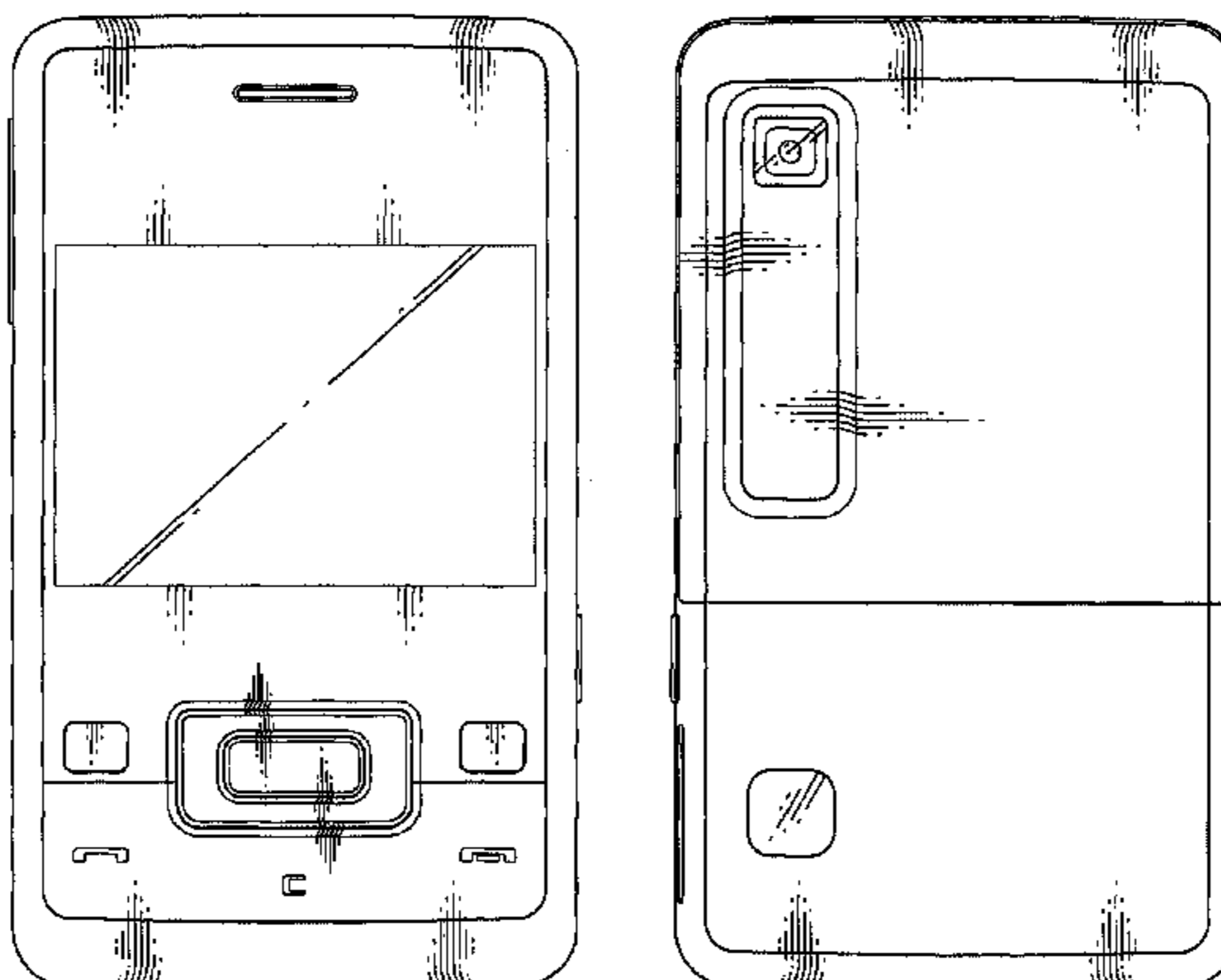

FIG. 1

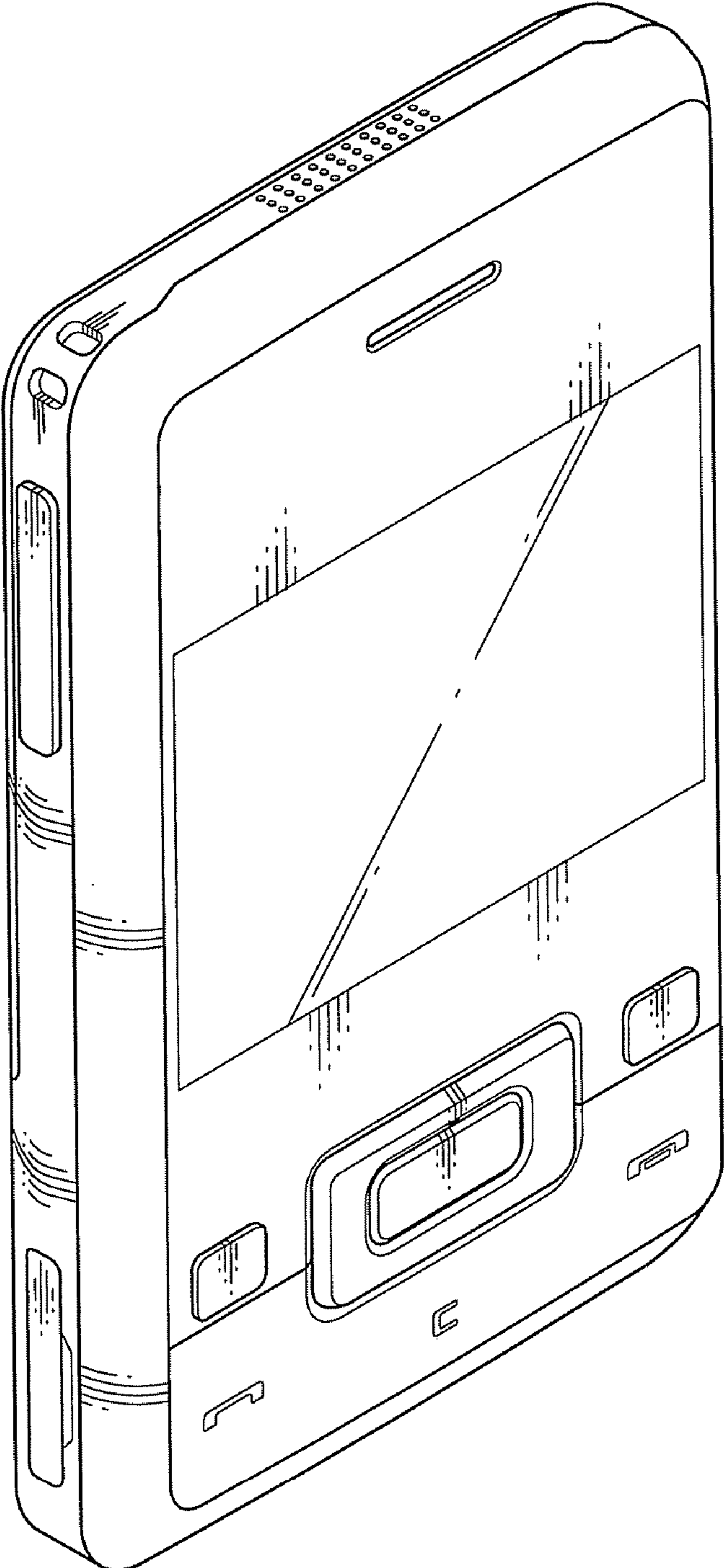

FIG.2

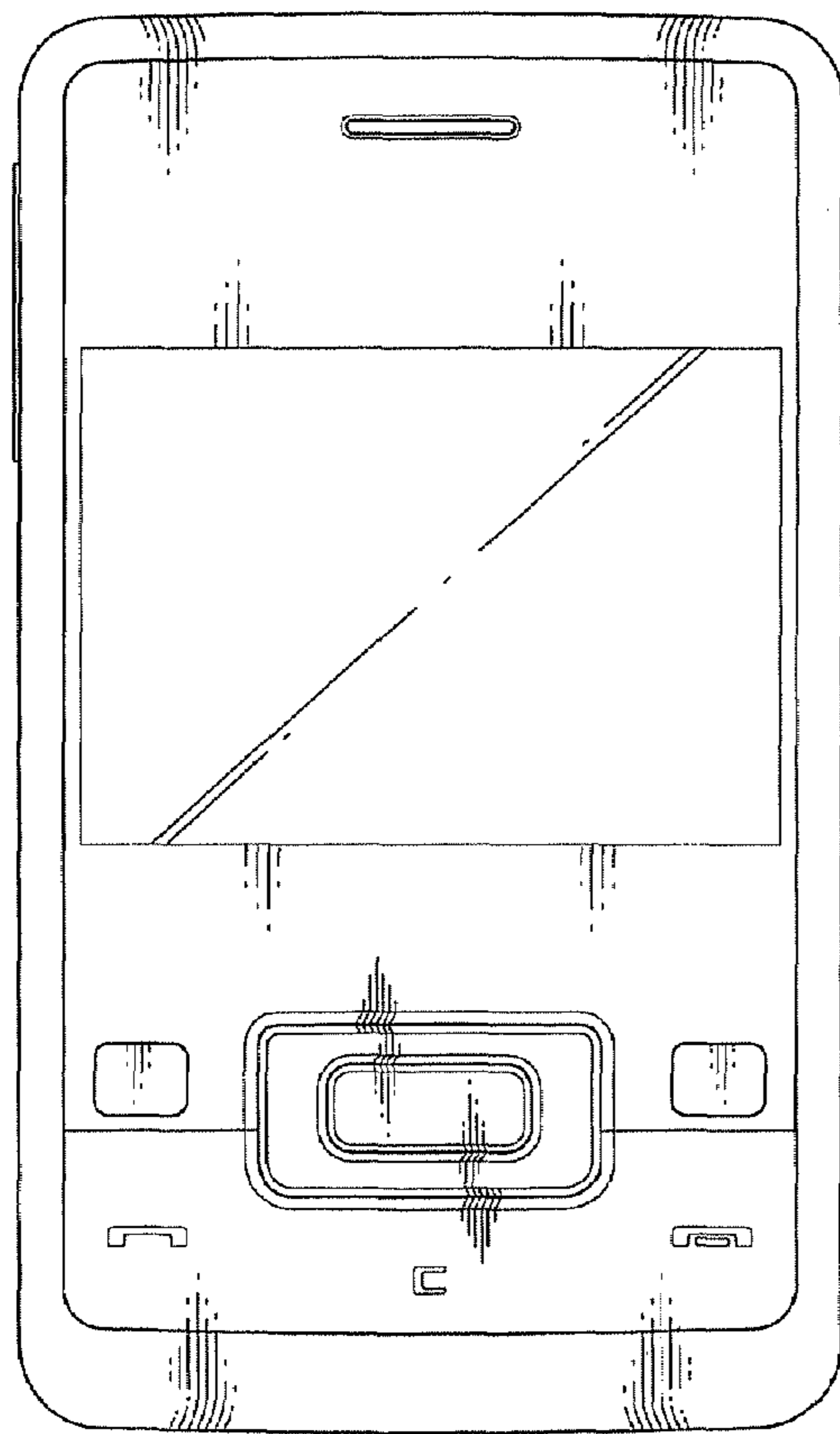

FIG.3

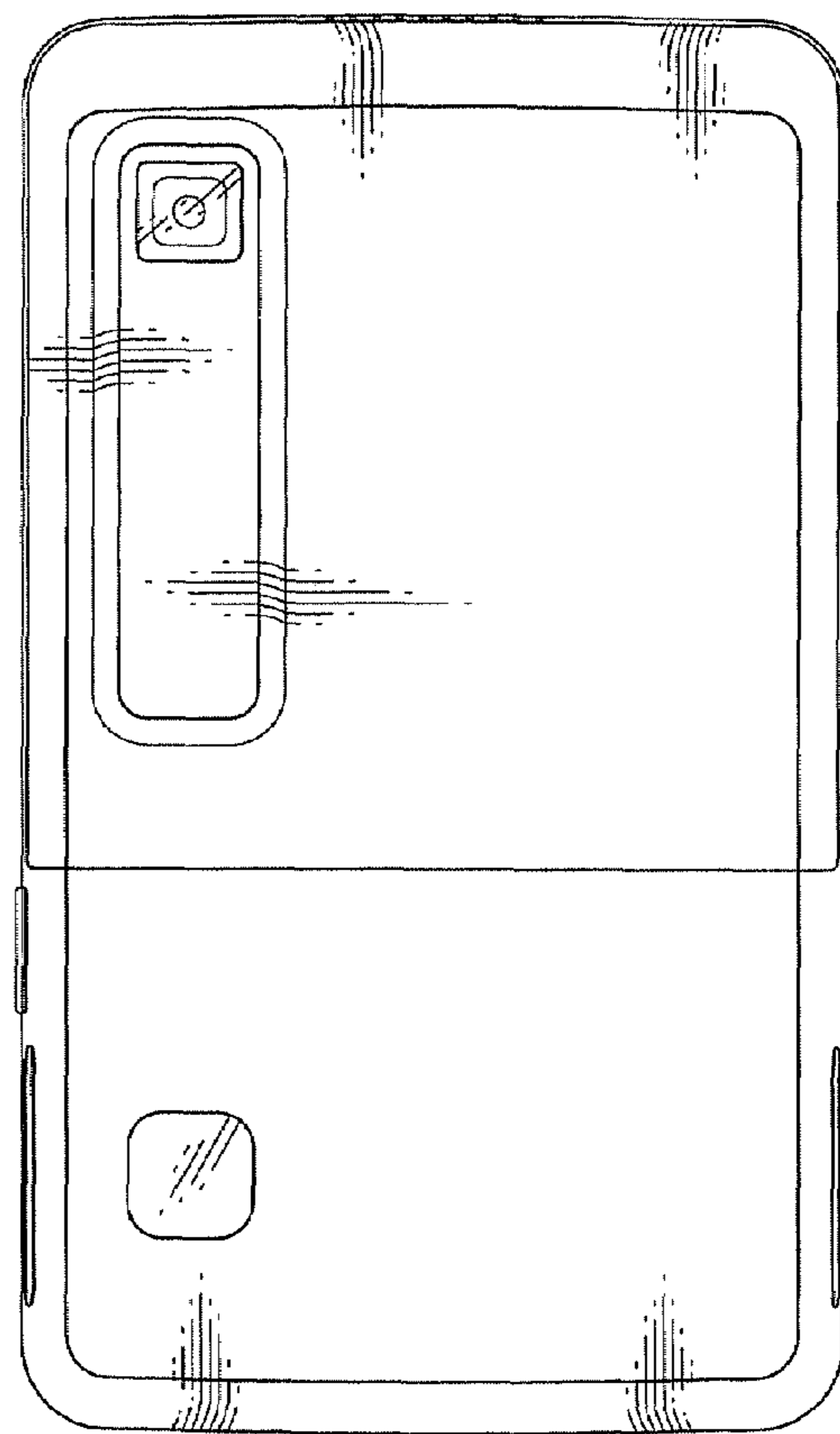

FIG.4

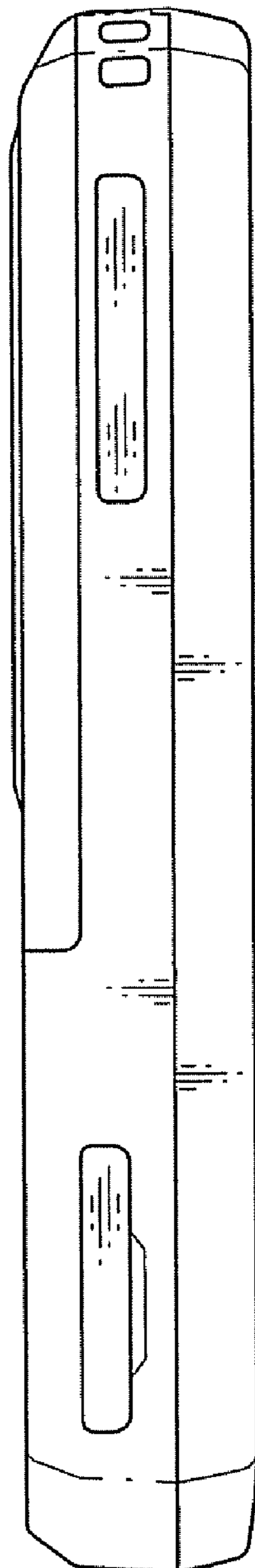

FIG.5

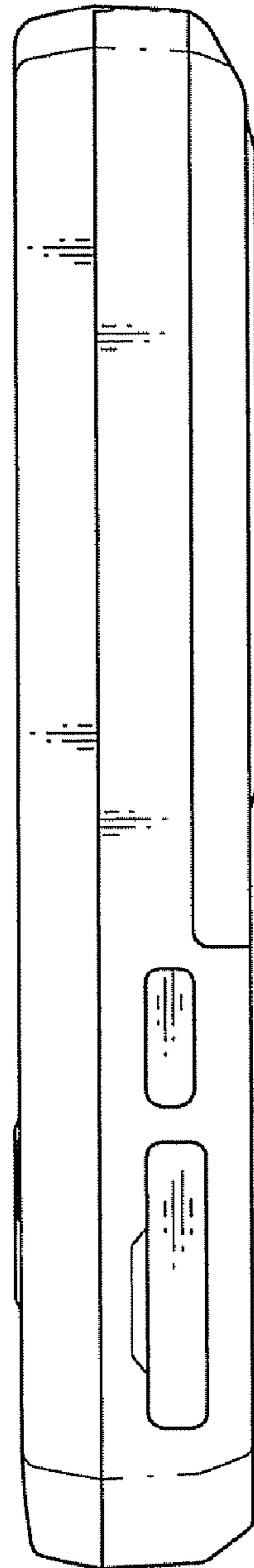

FIG. 6

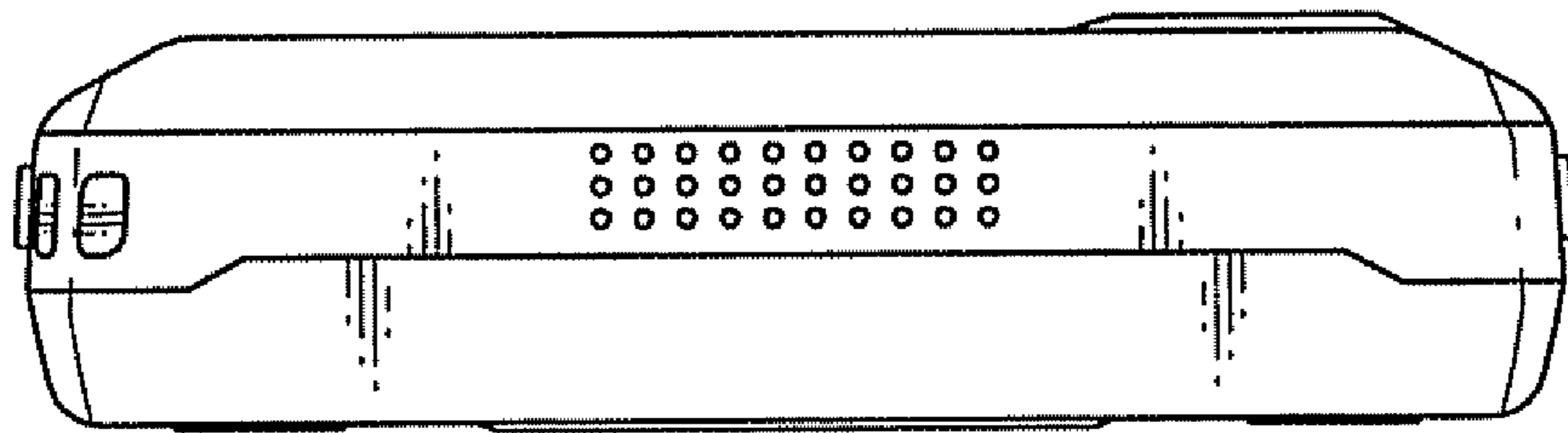

FIG. 7

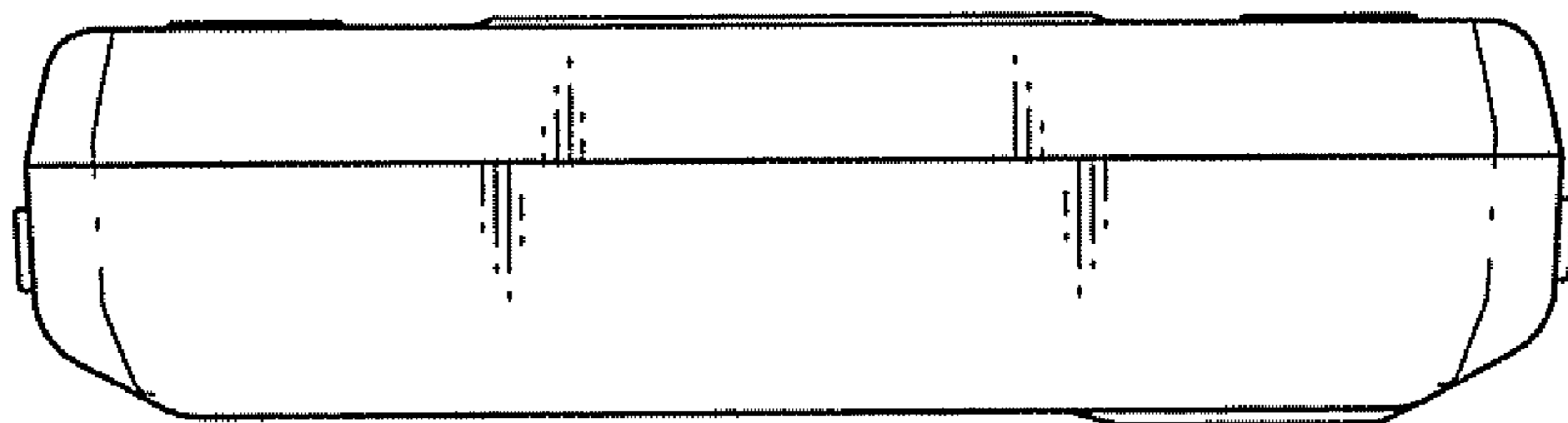

FIG. 8

