

US00D605153S

(12) **United States Design Patent**  
**Chung et al.**

(10) **Patent No.:** **US D605,153 S**  
(45) **Date of Patent:** **\*\* Dec. 1, 2009**

(54) **MOBILE PHONE**

(75) Inventors: **Simon Chung**, Singapore (SG); **Boon Sim Chong**, Singapore (SG)

(73) Assignee: **Sony Ericsson Mobile Communications AB**, Lund (SE)

(\*\*) Term: **14 Years**

(21) Appl. No.: **29/319,974**

(22) Filed: **Jun. 18, 2008**

(30) **Foreign Application Priority Data**

Jan. 4, 2008 (EM) ..... 000853106-0002

(51) **LOC (9) Cl.** ..... **14-03**

(52) **U.S. Cl.** ..... **D14/138 AA**

(58) **Field of Classification Search** ..... D14/137,  
D14/138 R, 138 AA, 138 AB, 138 AC, 138 AD,  
D14/138 C, 138 G, 147-148, 156, 191, 218,  
D14/247-248, 341-347, 390, 399, 455-456,  
D14/496; D10/65, 78, 104; D13/164, 168;  
D16/208; D18/7; D21/329, 331, 333, 517;  
343/702; 345/167, 168, 169; 348/14.01-14.02;  
361/814; 379/433.01-433.13; 439/165;  
455/90.3, 556.1-556.2, 566, 575.1, 575.3,  
455/575.4

See application file for complete search history.

(56) **References Cited**

**U.S. PATENT DOCUMENTS**

D496,642 S \* 9/2004 Harries et al. .... D14/138 AA  
D505,932 S \* 6/2005 Eckholm et al. .... D14/138 AA  
D513,741 S \* 1/2006 Jensfelt ..... D14/138 AA  
D543,967 S \* 6/2007 Peng ..... D14/138 AA  
D546,314 S \* 7/2007 Im ..... D14/138 AA  
D570,317 S \* 6/2008 Eklund ..... D14/138 AA

D573,970 S \* 7/2008 Park ..... D14/138 AA  
D575,255 S \* 8/2008 De Leon et al. .... D14/138 AA  
D582,374 S \* 12/2008 Hu et al. .... D14/138 AA  
D584,269 S \* 1/2009 Baik et al. .... D14/138 AA  
D587,669 S \* 3/2009 Aarras ..... D14/138 AA  
D589,926 S \* 4/2009 Turner ..... D14/138 AA  
2004/0204060 A1 \* 10/2004 Makinouchi et al. .... 455/556.1

**OTHER PUBLICATIONS**

O2 Ice, announced Aug. 2006, <URL:http://www.gsmarena.com/o2\_ice-pictures-1706.php>, retrieved from internet May 20, 2009.\*  
Sony Ericsson K320, announced Sep. 2006, <URL:http://www.gsmarena.com/sony\_ericsson\_k320-pictures-1722.php>, retrieved from internet May 20, 2009.\*

\* cited by examiner

*Primary Examiner*—Ian Simmons

*Assistant Examiner*—Carla Jobe Wright

(74) *Attorney, Agent, or Firm*—Renner, Otto, Boisselle & Sklar, LLP

(57) **CLAIM**

The ornamental design for a mobile telephone, as shown and described.

**DESCRIPTION**

FIG. 1 is a front view of a mobile phone showing our design;  
FIG. 2 is a rear view thereof;  
FIG. 3 is a perspective view thereof;  
FIG. 4 is a right side view thereof;  
FIG. 5 is a left side view thereof;  
FIG. 6 is a top view thereof; and,  
FIG. 7 is a bottom view thereof.

The broken lines shown herein are for illustrative purposes only and form no part of the claimed design.

**1 Claim, 5 Drawing Sheets**

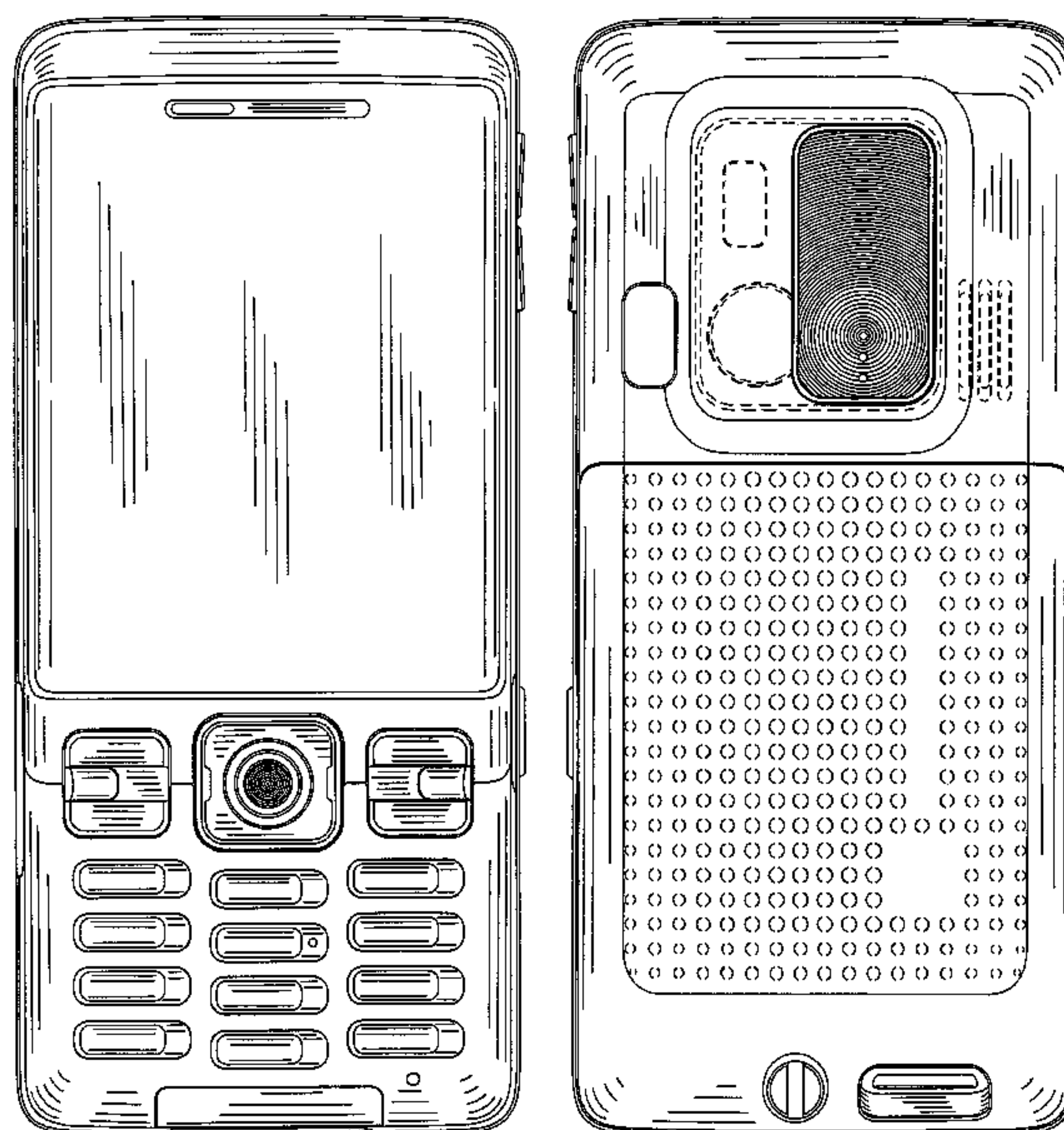

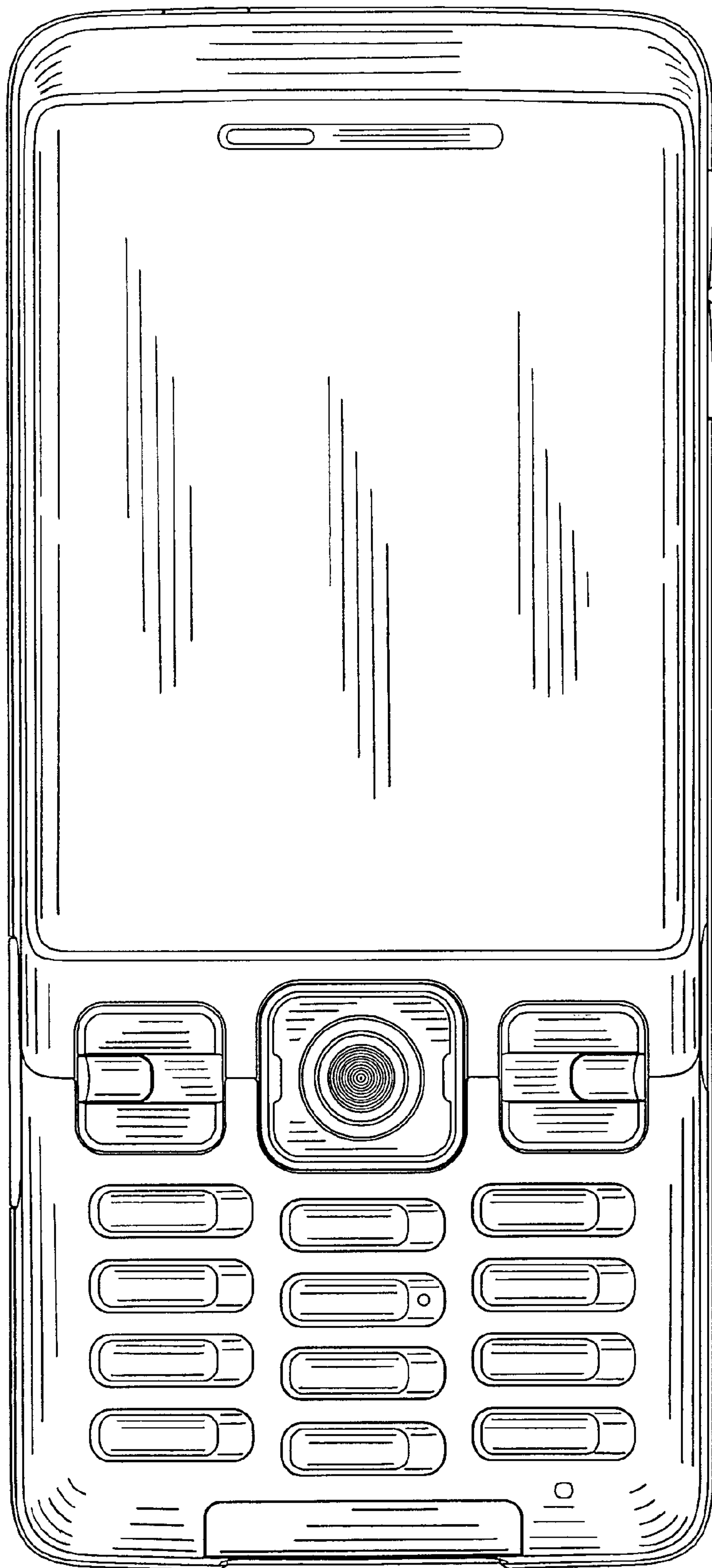

FIG. 1

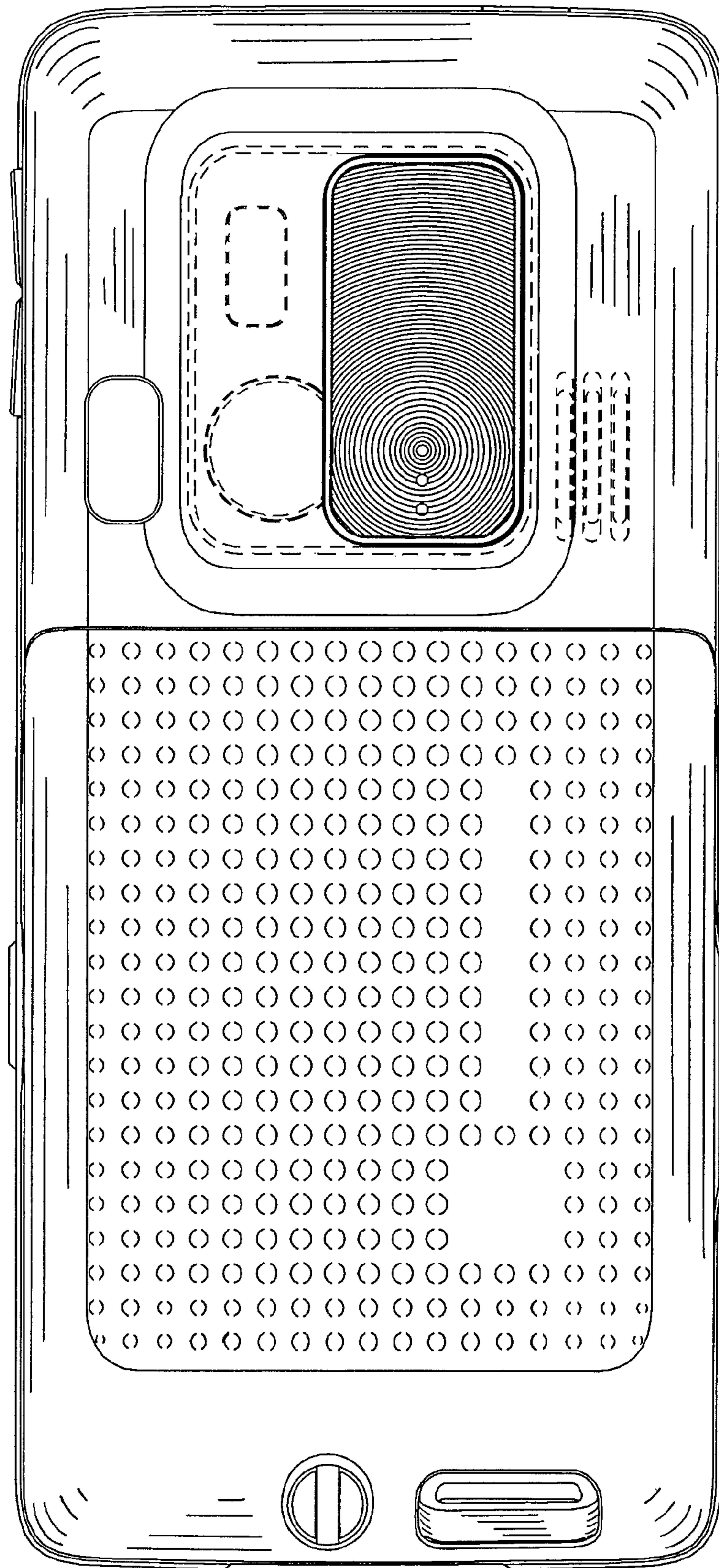

FIG. 2



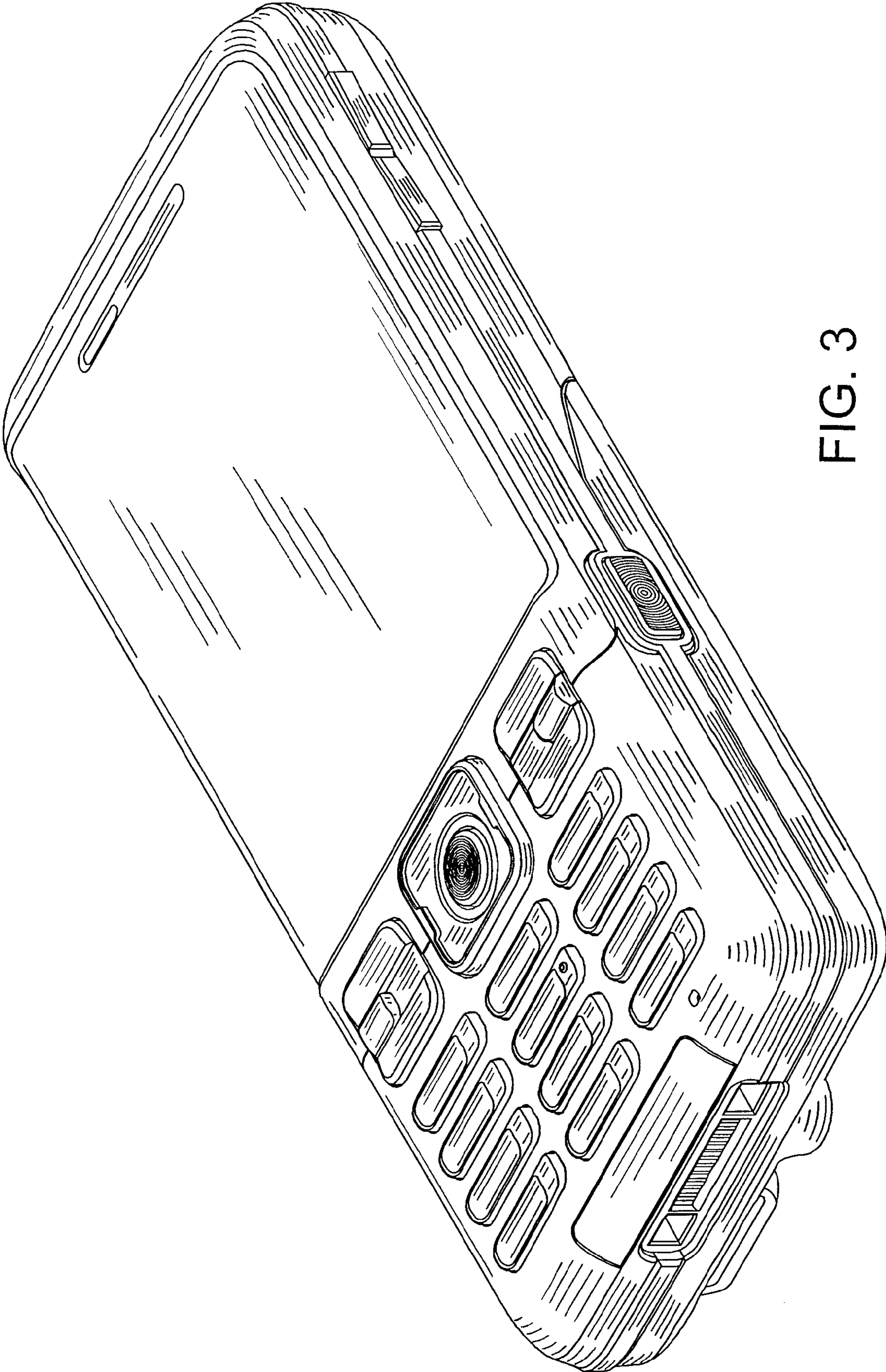

FIG. 3

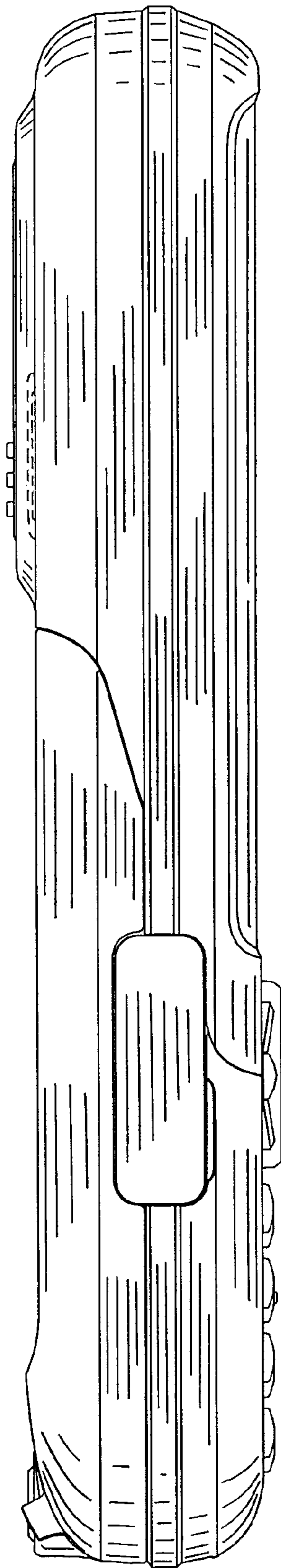

FIG. 5

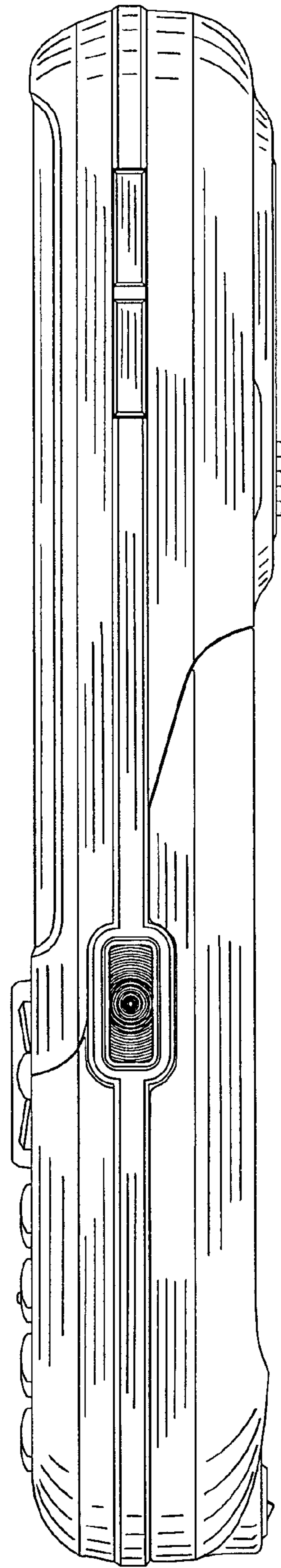

FIG. 4

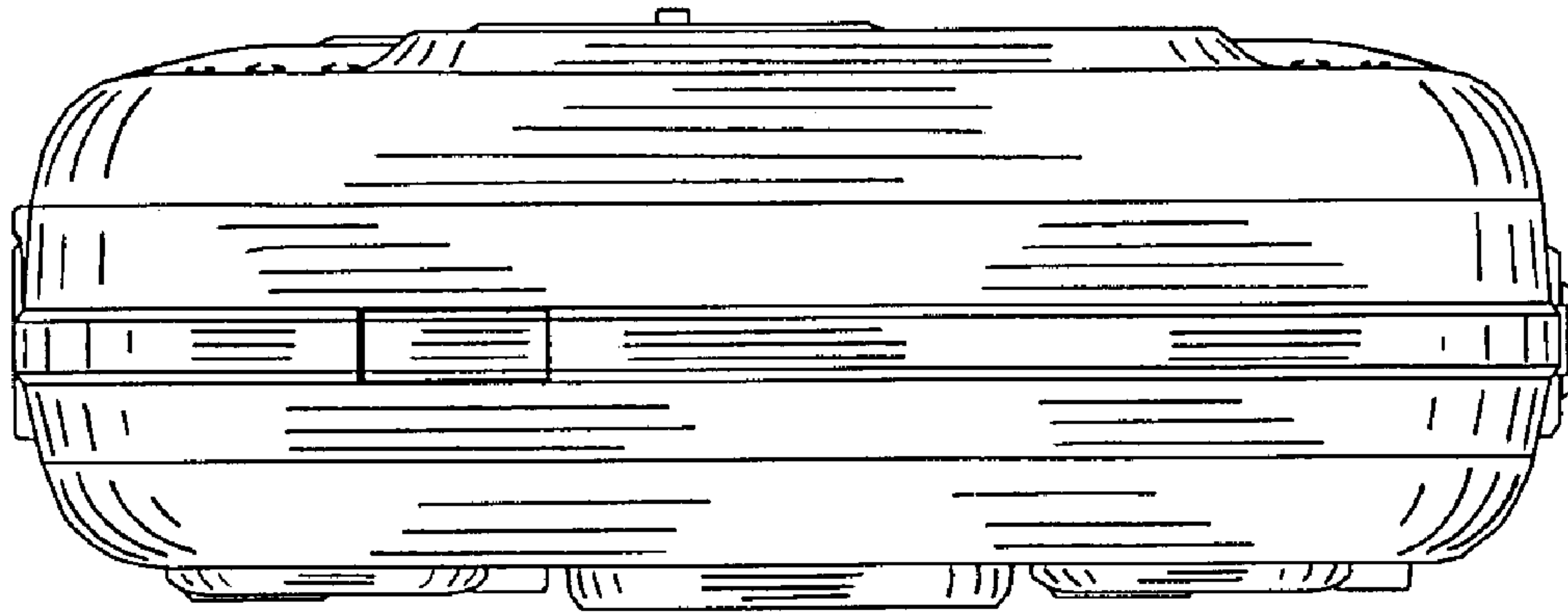

FIG. 6

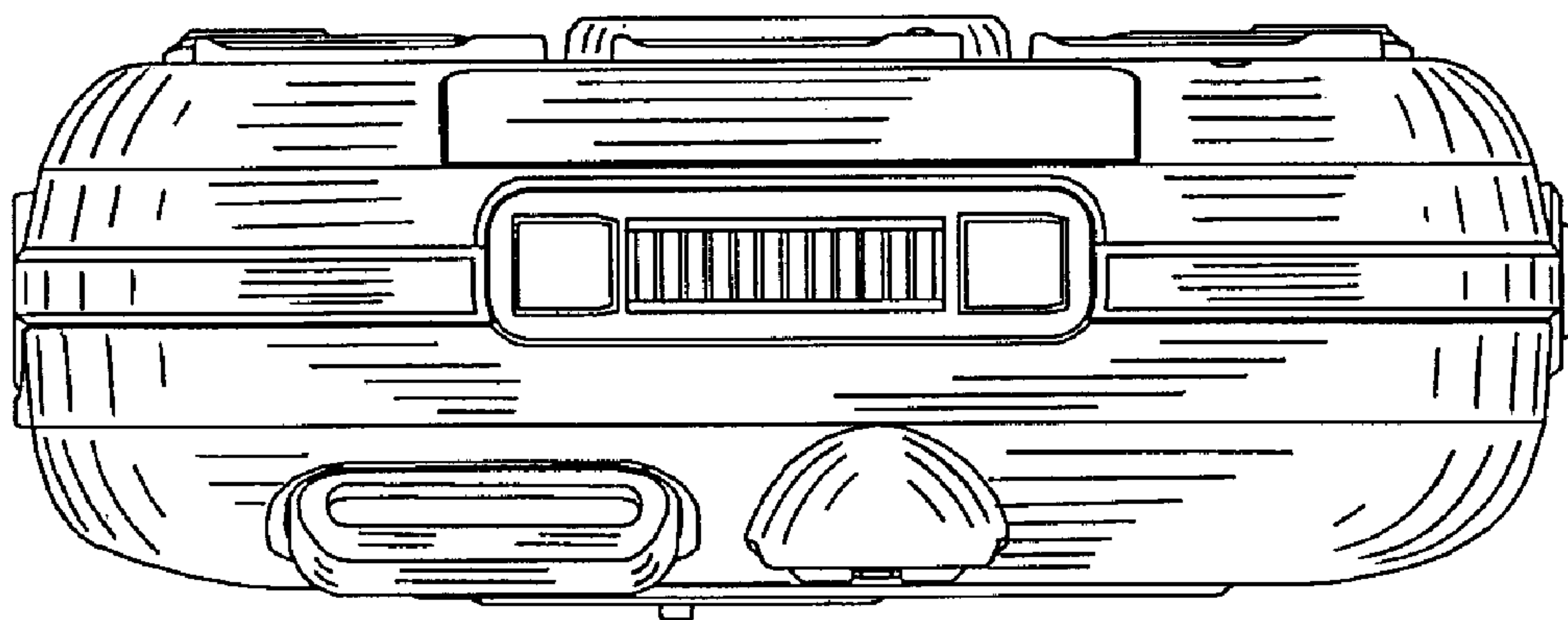

FIG. 7