



US00D605050S

(12) **United States Design Patent**  
**Bohache et al.**

(10) **Patent No.:** **US D605,050 S**  
(45) **Date of Patent:** **\*\* Dec. 1, 2009**

(54) **BOTTLE**

(75) Inventors: **Joseph Bohache**, Milford, OH (US);  
**Maria Christine Boustead**, Chicago, IL  
(US); **Erica Heidi Hollmann**, Kenosha,  
WI (US)

(73) Assignee: **The Procter & Gamble Company**,  
Cincinnati, OH (US)

(\*\*) Term: **14 Years**

(21) Appl. No.: **29/305,680**

(22) Filed: **Mar. 26, 2008**

(51) **LOC (9) Cl.** ..... **09-01**

(52) **U.S. Cl.** ..... **D9/530; D9/529**

(58) **Field of Classification Search** ..... D9/434,  
D9/435, 447, 449, 516, 522, 529, 530, 537,  
D9/539, 540, 542, 543, 545, 549, 550, 572-575;  
215/382-384; 220/660, 662, 669, 675  
See application file for complete search history.

(56) **References Cited**

U.S. PATENT DOCUMENTS

D444,388 S	7/2001	Bakic	
D472,475 S	4/2003	Pinard	
D486,400 S	2/2004	Bakic	
D520,374 S *	5/2006	Herrmann et al. ....	D9/561
D529,811 S	10/2006	Ratzlaff	
D533,966 S *	12/2006	Bakic .....	D28/76
D543,850 S *	6/2007	Legros .....	D9/522

\* cited by examiner

*Primary Examiner*—Stella M Reid

*Assistant Examiner*—Keli L Hill

(74) *Attorney, Agent, or Firm*—Kelly L. McDow

(57) **CLAIM**

The ornamental design for a bottle, as shown and described.

**DESCRIPTION**

FIG. 1 is a perspective view of a bottle embodying our new design;

FIG. 2 is a front view thereof;

FIG. 3 is a rear view thereof;

FIG. 4 is a right side view thereof;

FIG. 5 is a left side view thereof;

FIG. 6 is a top view thereof;

FIG. 7 is a bottom view thereof;

FIG. 8 is a side perspective view of a second embodiment of a bottle embodying our new design;

FIG. 9 is a front view thereof;

FIG. 10 is a rear view thereof;

FIG. 11 is a right side view thereof;

FIG. 12 is a left side view thereof;

FIG. 13 is a top view thereof; and,

FIG. 14 is a bottom view thereof.

Broken lines are included herein for illustrative purposes only and form no part of the claimed design.

**1 Claim, 8 Drawing Sheets**

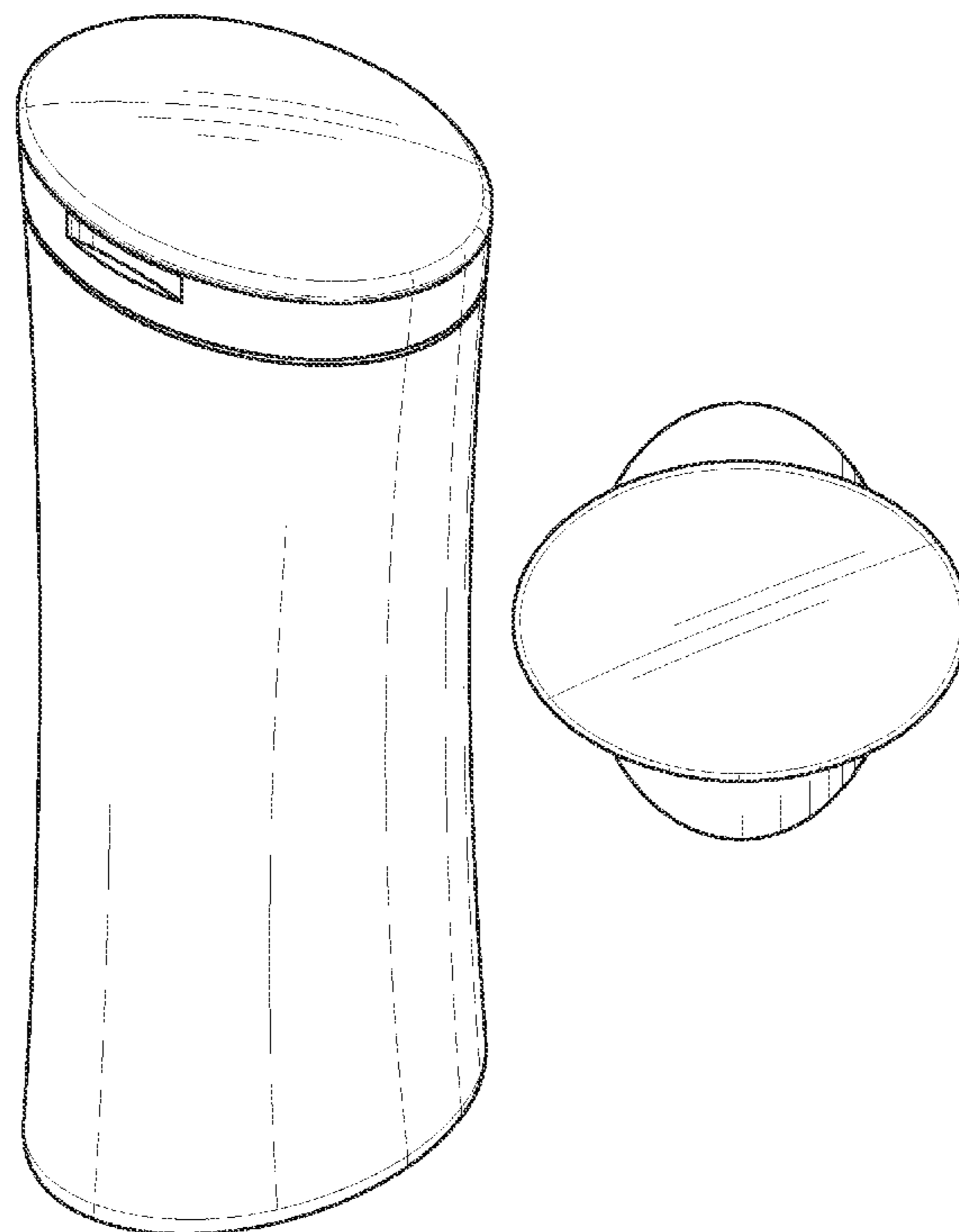

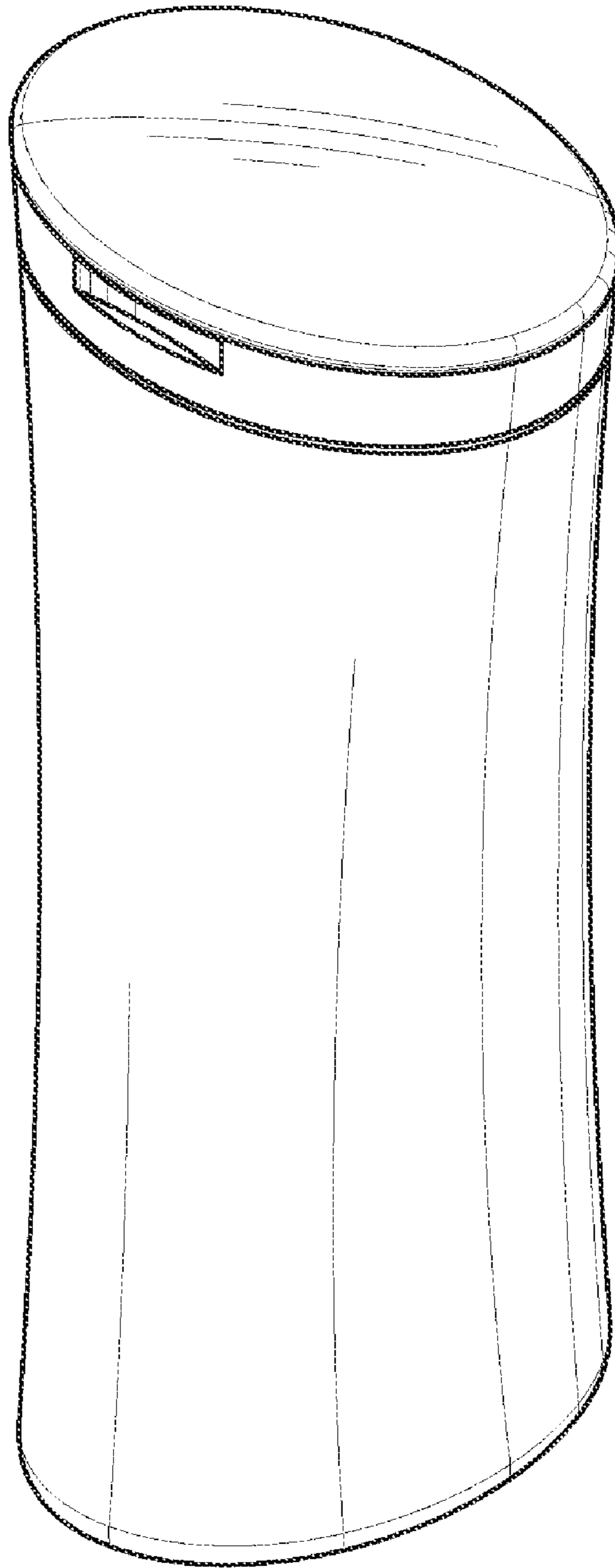

**Fig. 1**

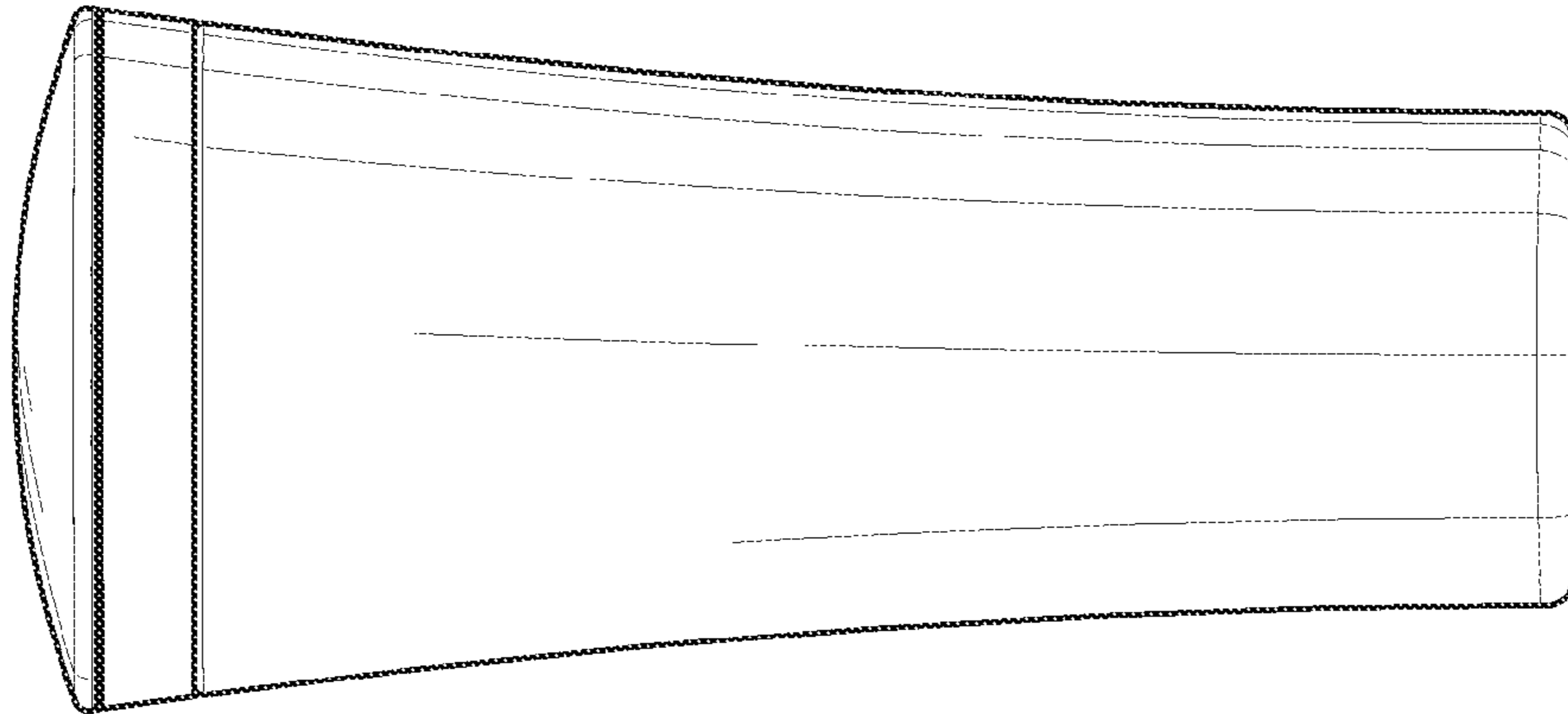

Fig. 3

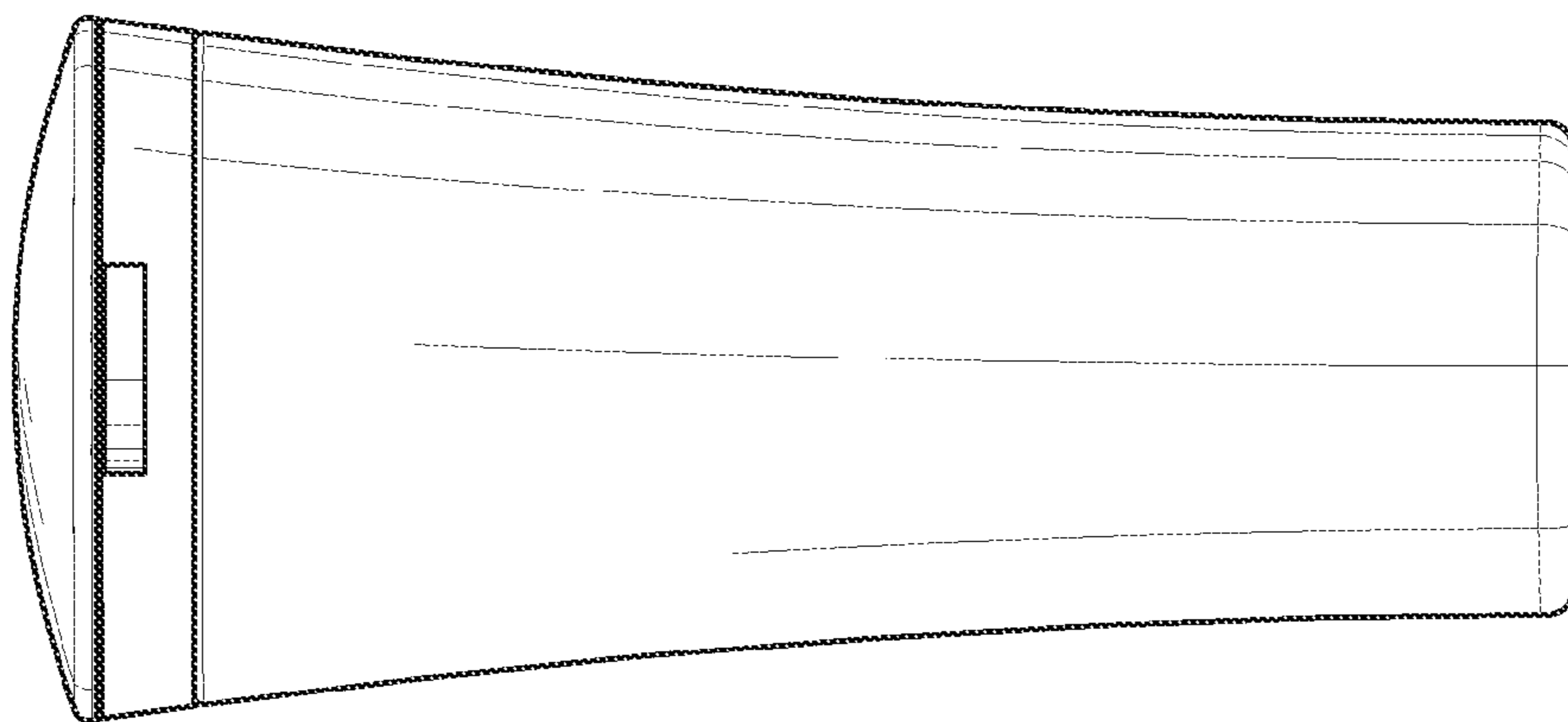

Fig. 2

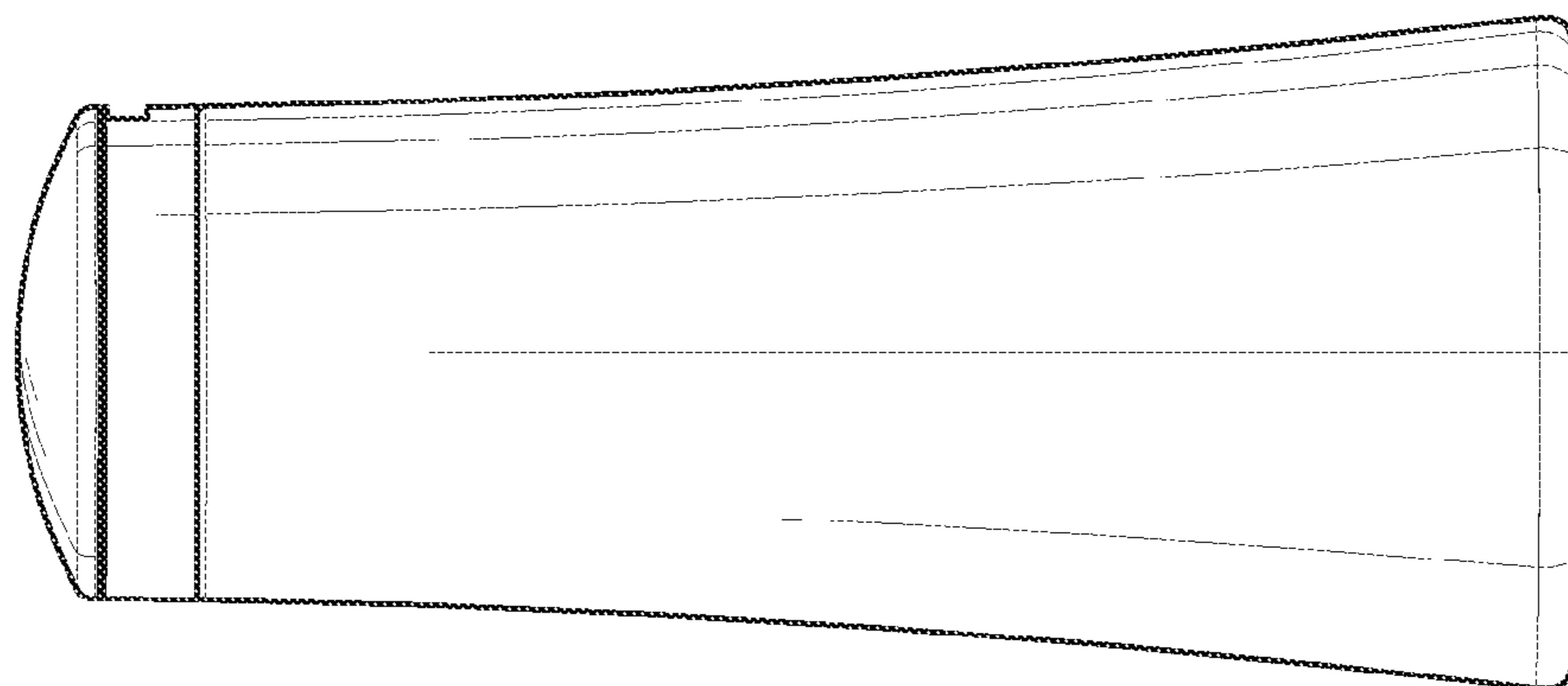

Fig. 5

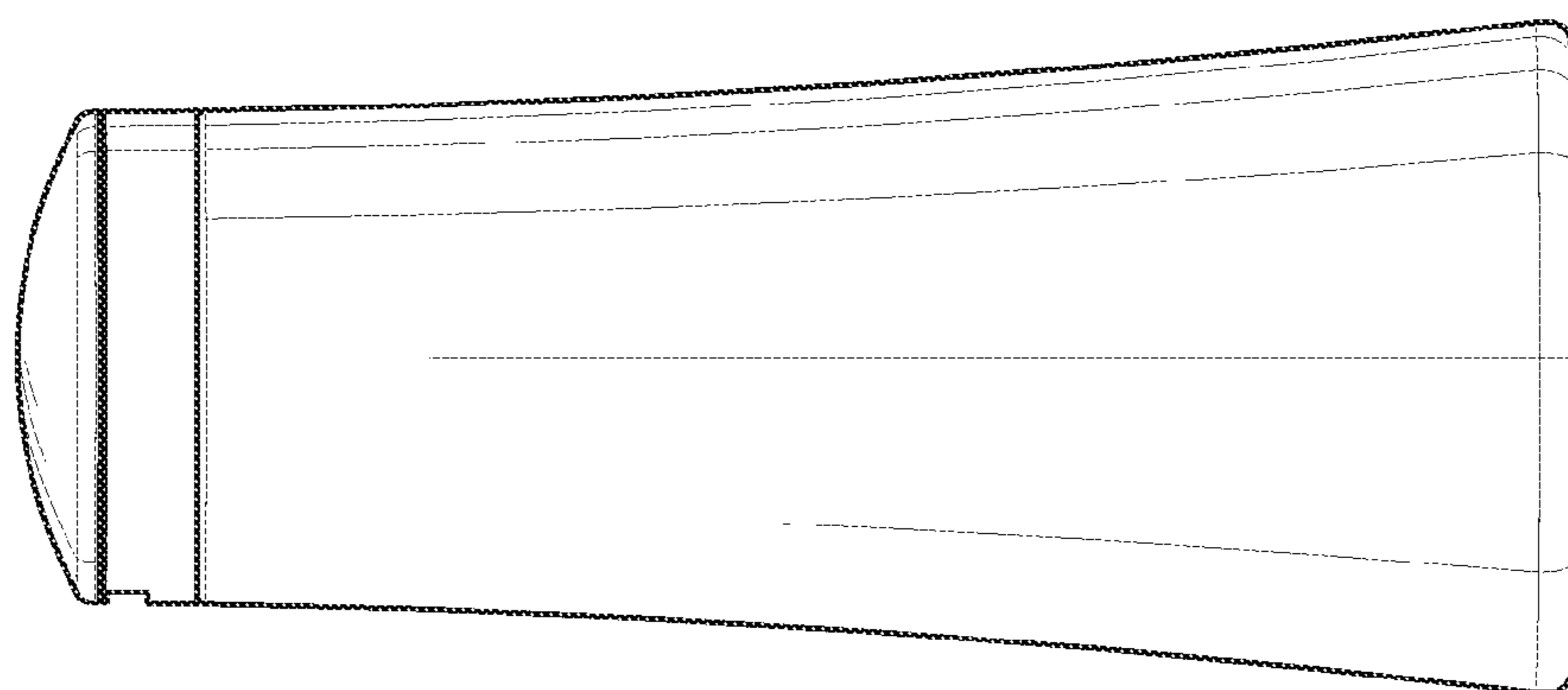

Fig. 4

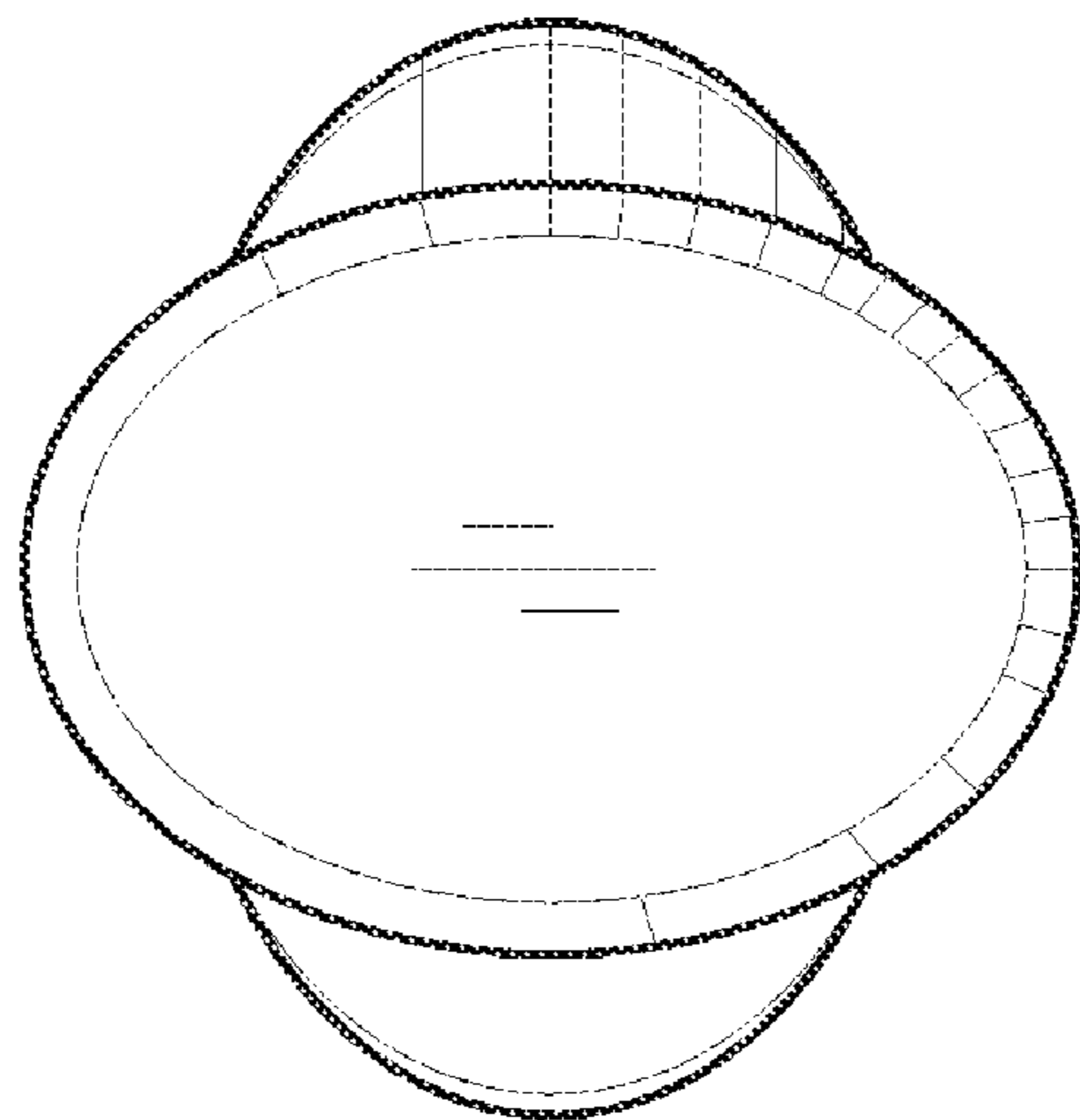

Fig. 6

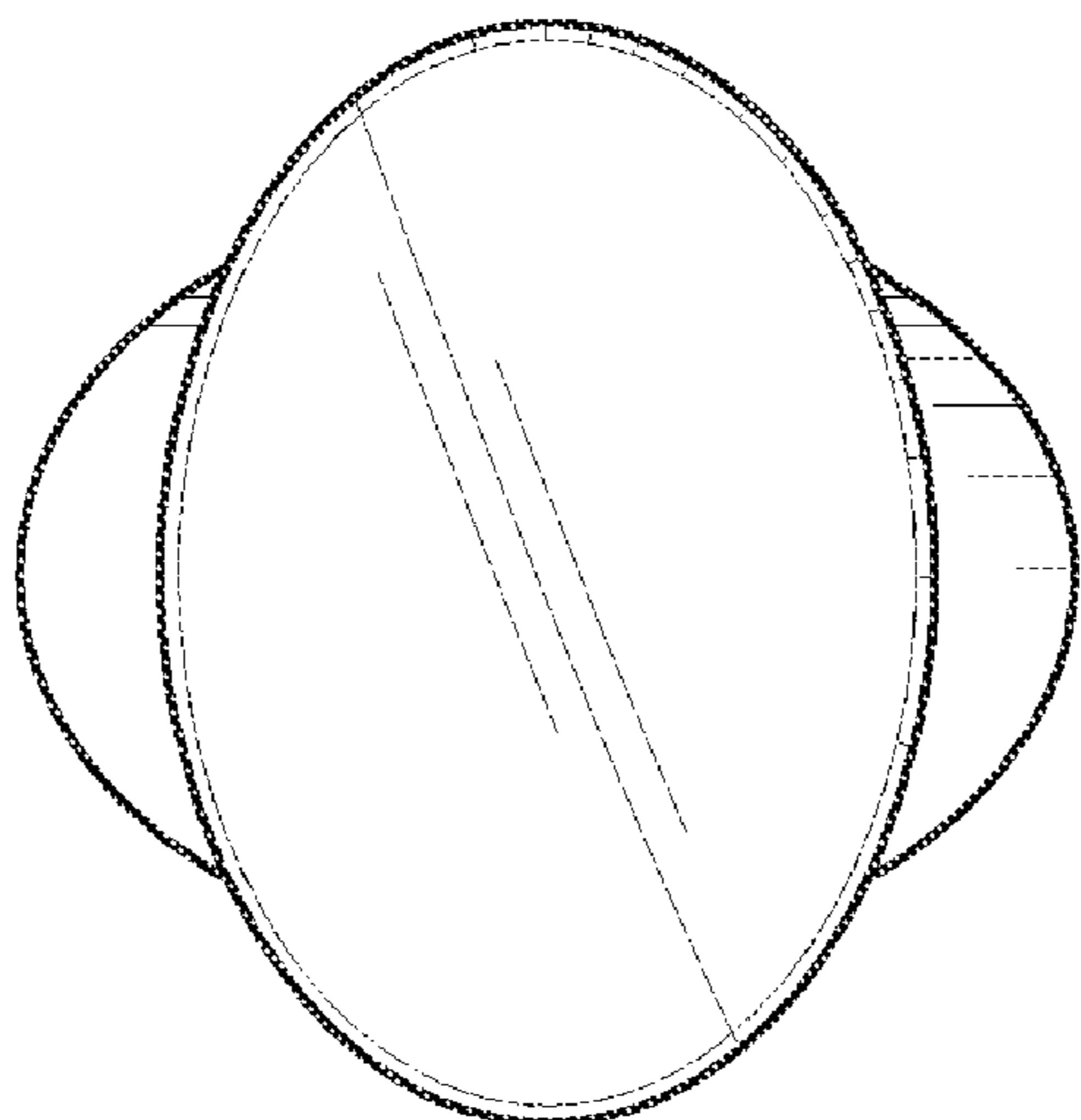
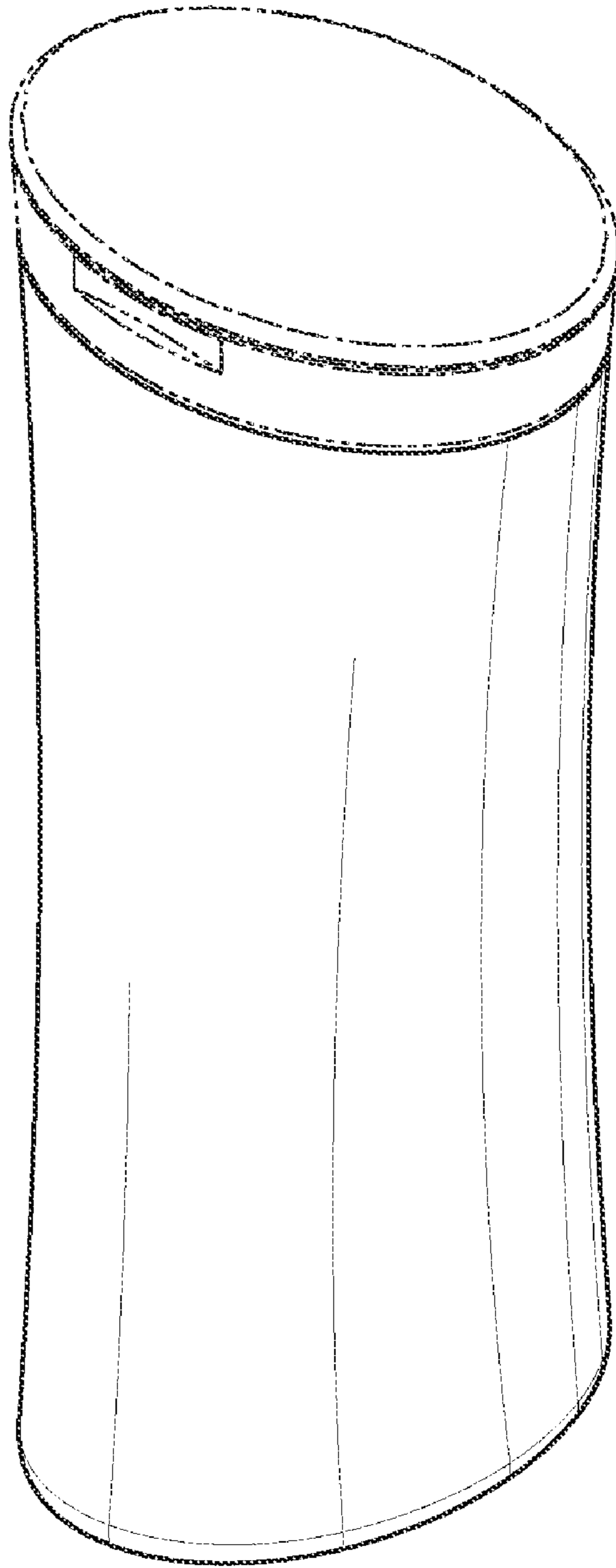

Fig. 7



**Fig. 8**

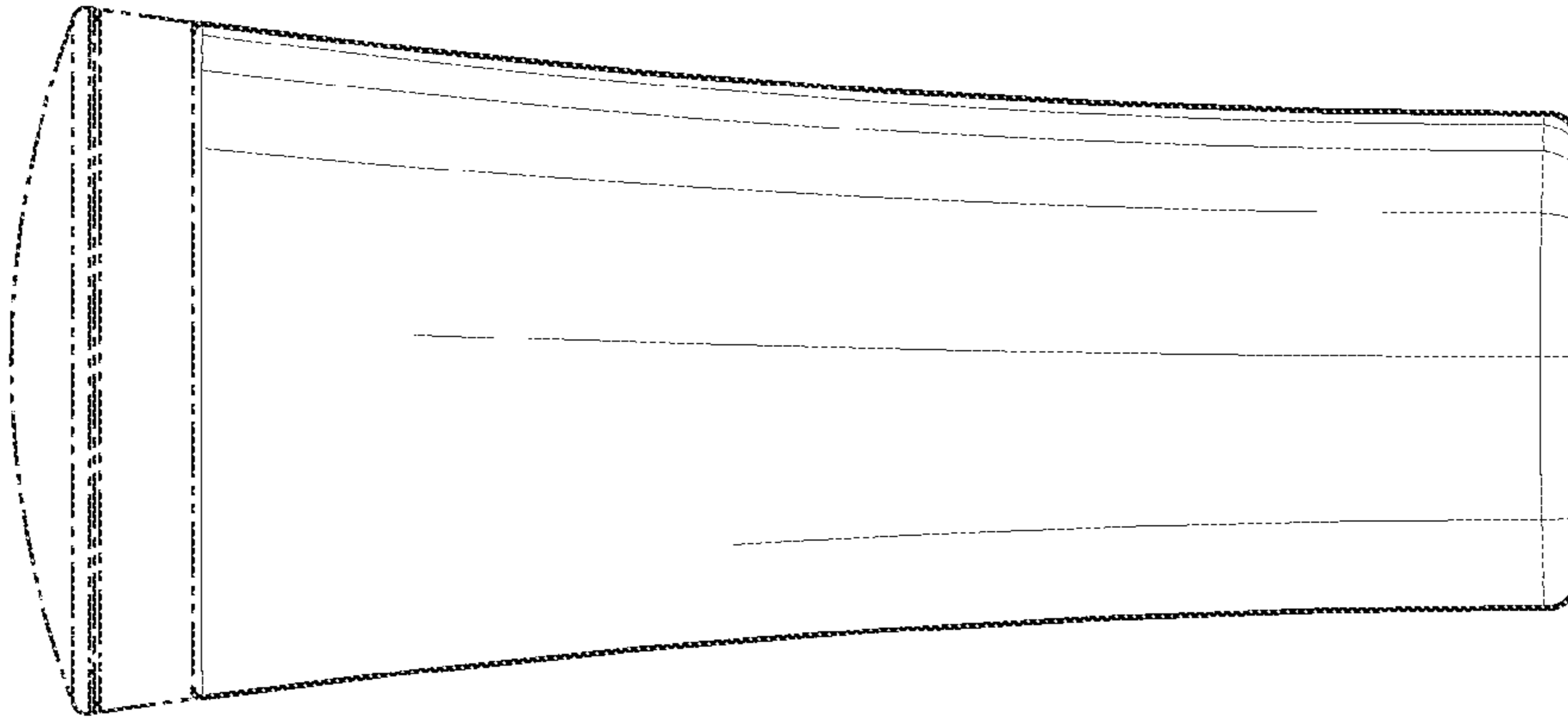

Fig. 9

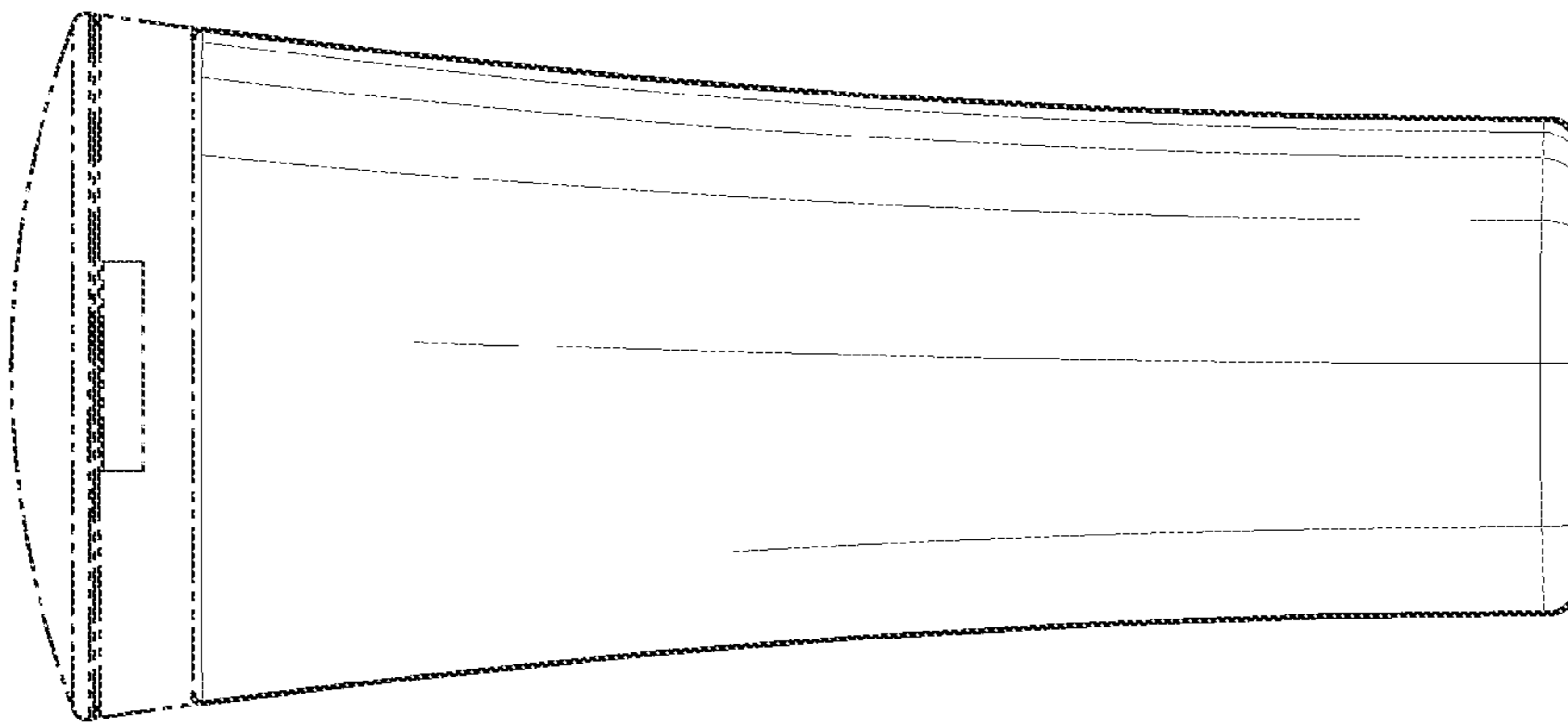

Fig. 10

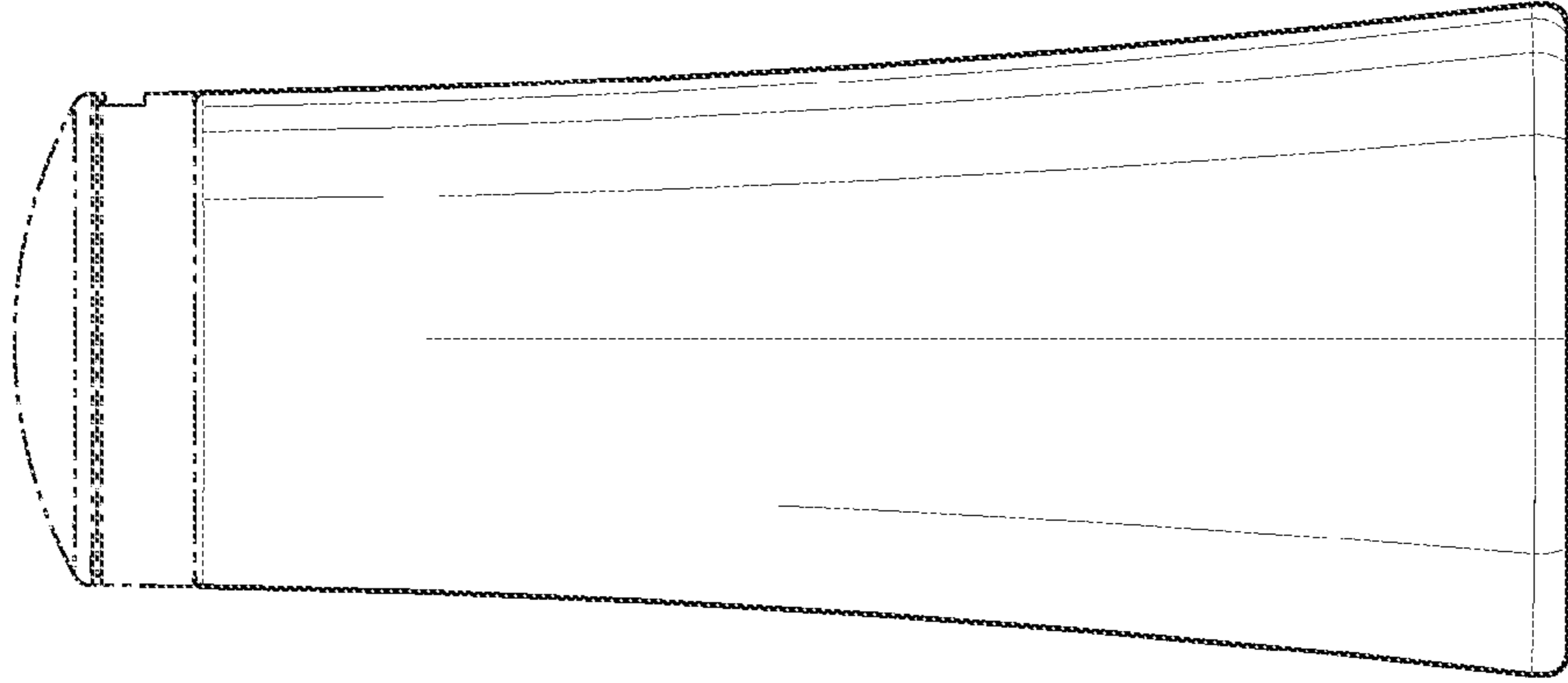

Fig. 11

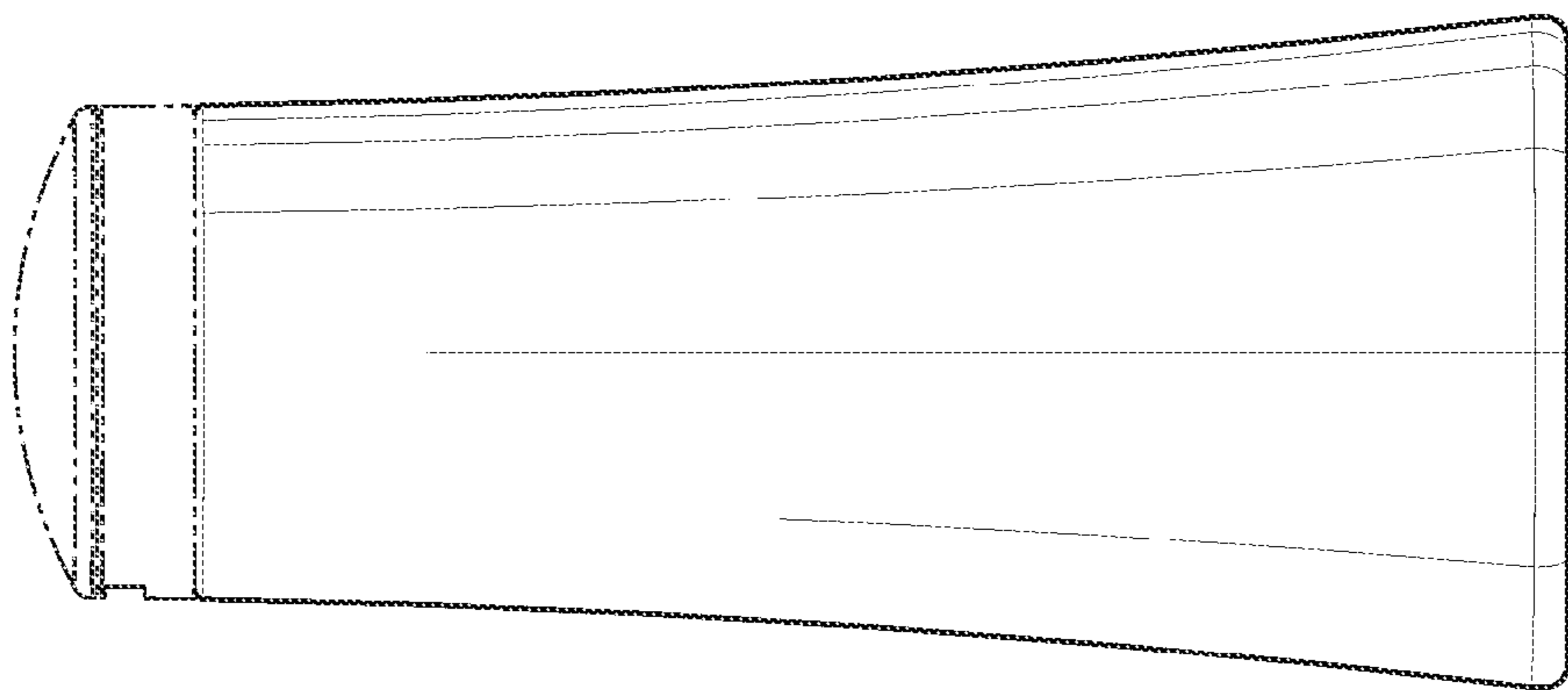

Fig. 12



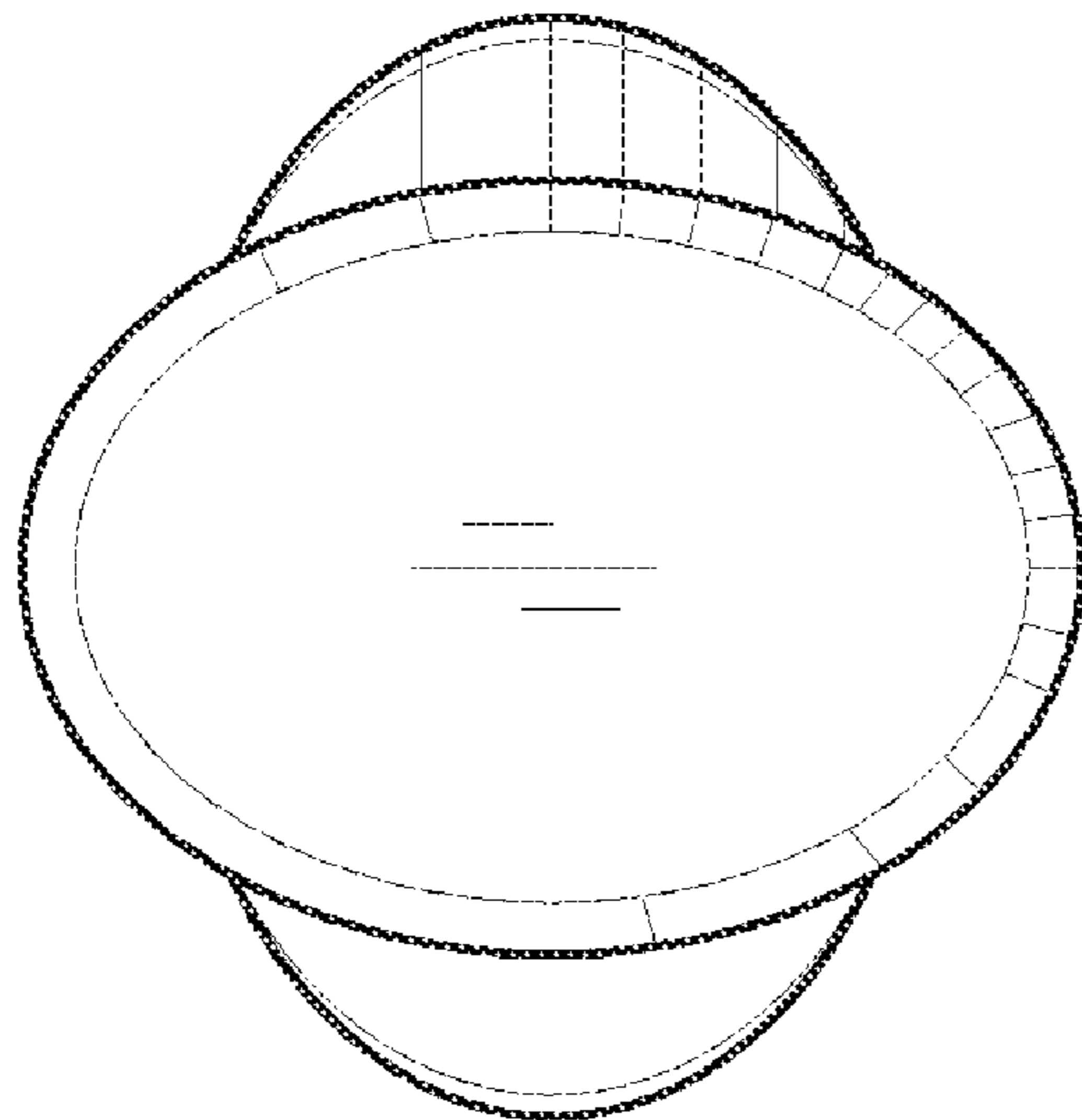

Fig. 13

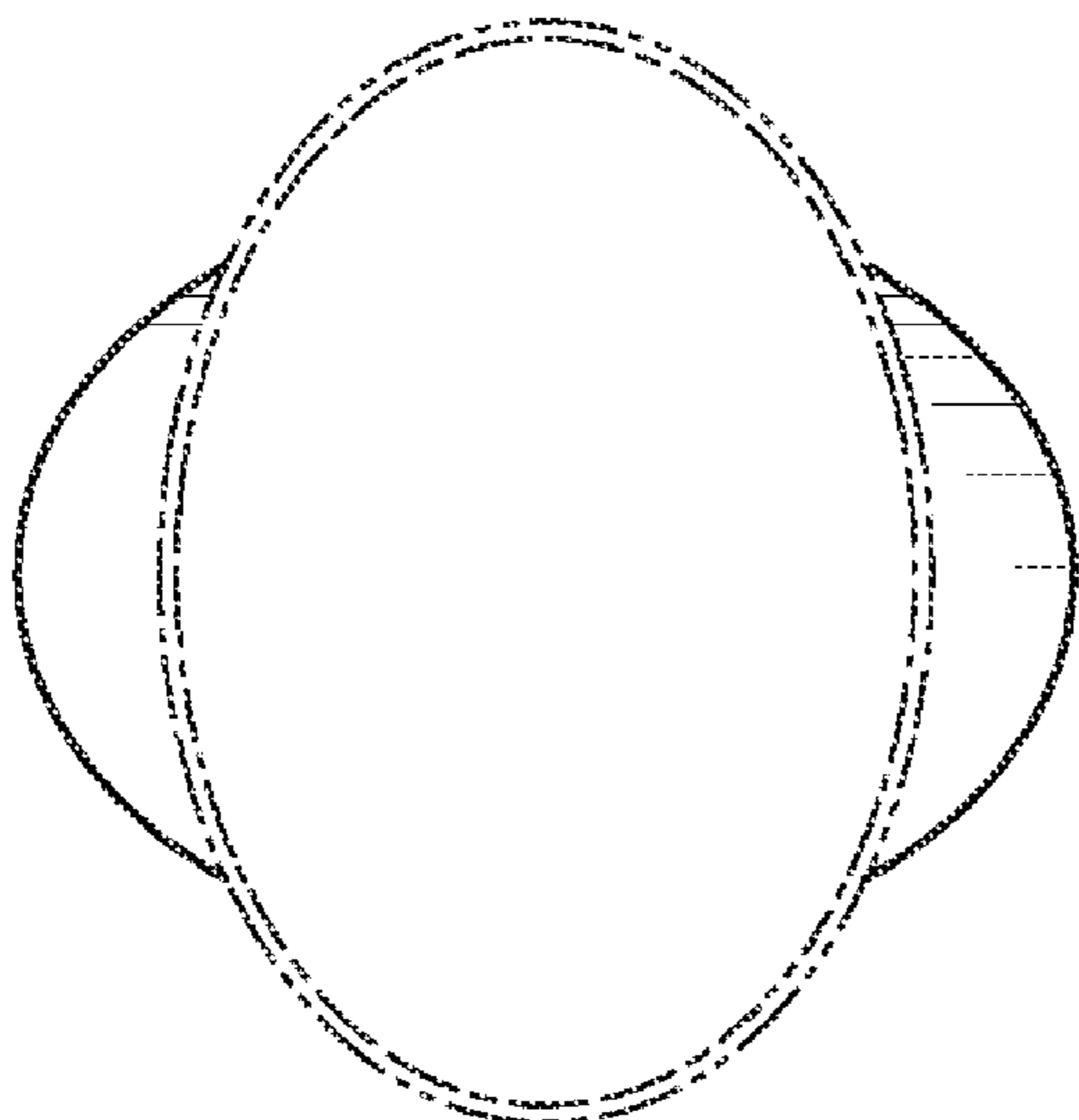

Fig. 14