



US00D605002S

(12) **United States Design Patent**
Cox

(10) **Patent No.:** **US D605,002 S**
(45) **Date of Patent:** **** *Dec. 1, 2009**

(54) **STAKE WITH TWO ATTACHED CLIPS AND REMOVEABLE VARIABLE ORNAMENTAL TOP**

(74) *Attorney, Agent, or Firm*—Richard D. Clarke

(76) **Inventor:** **Jon C. Cox**, 1123 Azul Ct., Oceanside, CA (US) 92057

(57) **CLAIM**

(*) **Notice:** This patent is subject to a terminal disclaimer.

I claim the ornamental design for a stake with two attached clips and removable variable ornamental top, as shown and described.

(**) **Term:** **14 Years**

DESCRIPTION

(21) **Appl. No.:** **29/329,408**

FIG. 1 is a side elevation view of the stake with two attached clips, shown in use with an attached removable variable ornamental top;

(22) **Filed:** **Dec. 15, 2008**

FIG. 2 is a side elevation view of the stake portion alone;

Related U.S. Application Data

(63) Continuation-in-part of application No. 29/293,299, filed on Nov. 15, 2007, now Pat. No. Des. 582,732.

FIG. 3 is a bottom view of the stake portion alone;

(51) **LOC (9) Cl.** **08-01**

(52) **U.S. Cl.** **D8/1**

(58) **Field of Classification Search** D8/1,
D8/356; 47/47; 135/118; D26/67; 248/87,
248/156

FIG. 4 is another side elevation view of the stake portion alone;

FIG. 5 is another bottom view of the stake portion alone;

FIG. 6 is another side elevation view of the stake portion alone;

FIG. 7 is another bottom view of the stake portion alone;

FIG. 8 is a top plan view of the stake portion alone;

FIG. 9 is a side elevation view of the removable variable ornamental top alone;

See application file for complete search history.

FIG. 10 is a bottom view of the removable variable ornamental top alone;

FIG. 11 is a bottom perspective view of the removable variable ornamental top alone;

FIG. 12 is a top plan view of the stake with two attached clips; and,

FIG. 13 is a top perspective view of the stake with two attached clips.

FIGS. 2–13 are shown separated for ease of illustration.

The broken line drawing of the ornamental top is included for the purpose of illustrating environment and forms no part of the claimed design.

(56) **References Cited**

U.S. PATENT DOCUMENTS

D378,980	S	*	4/1997	Thayer et al.	D8/1
D379,416	S	*	5/1997	Adams	D8/1
D415,018	S	*	10/1999	Uhler	D21/840
D438,435	S	*	3/2001	Whyte	D8/1
D469,566	S	*	1/2003	Gary et al.	D26/138
D470,035	S	*	2/2003	Tisbo et al.	D8/356
D491,029	S	*	6/2004	Atkins et al.	D8/1
D516,029	S	*	2/2006	Stekelenburg	D13/139.4
D553,919	S	*	10/2007	Gross et al.	D8/1

* cited by examiner

Primary Examiner—Holly H Baynham

Assistant Examiner—Sheryl Lane

1 Claim, 4 Drawing Sheets

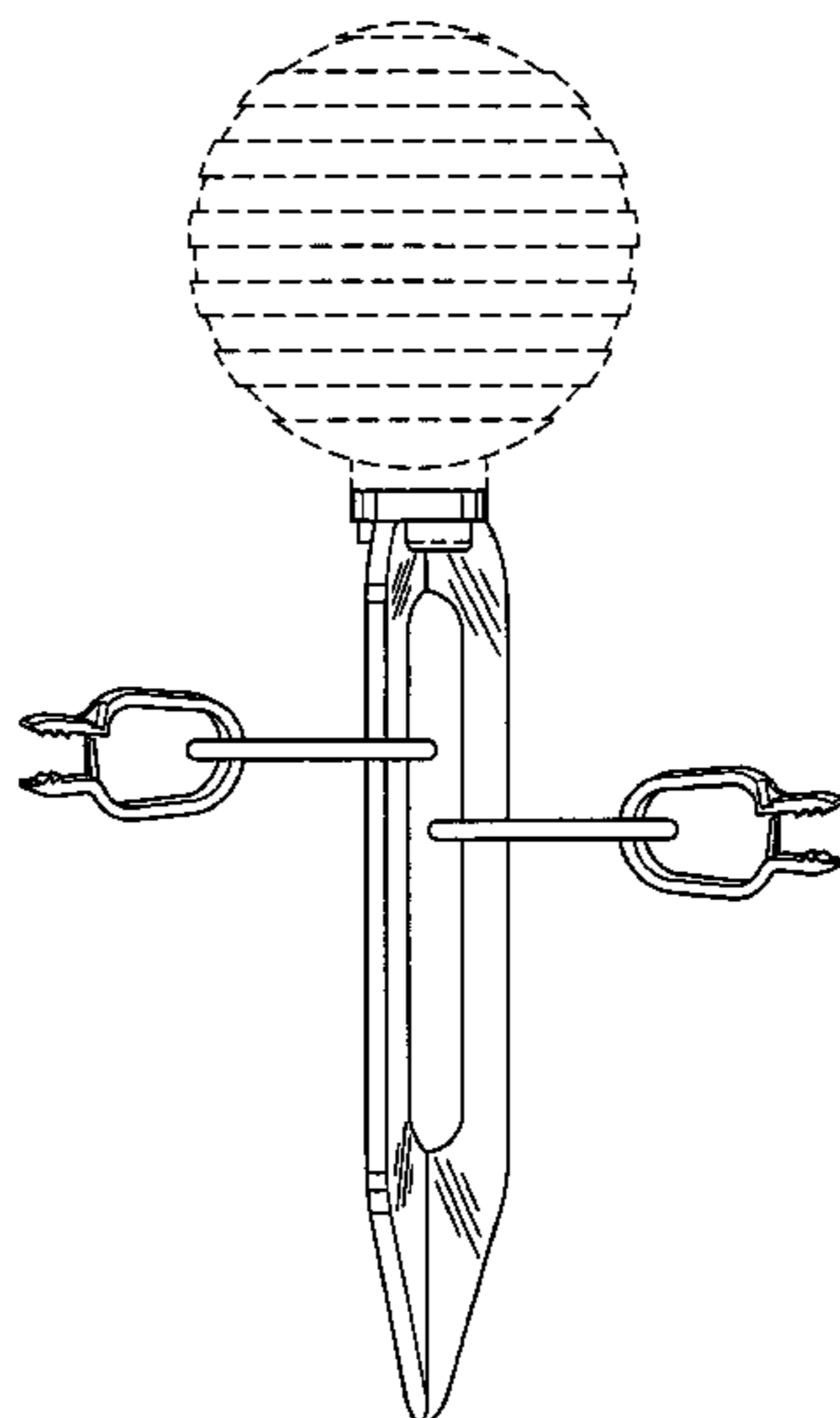

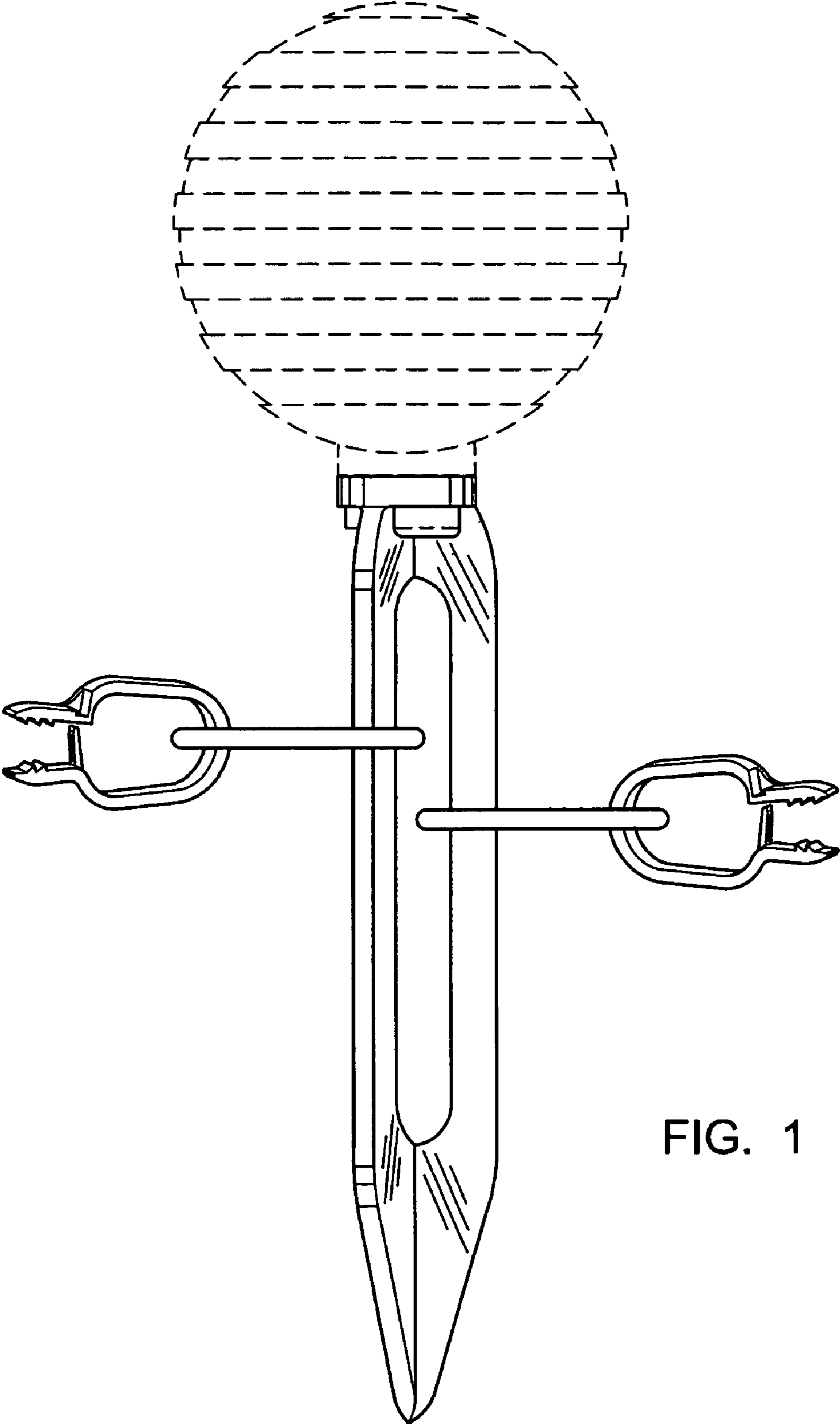

FIG. 1

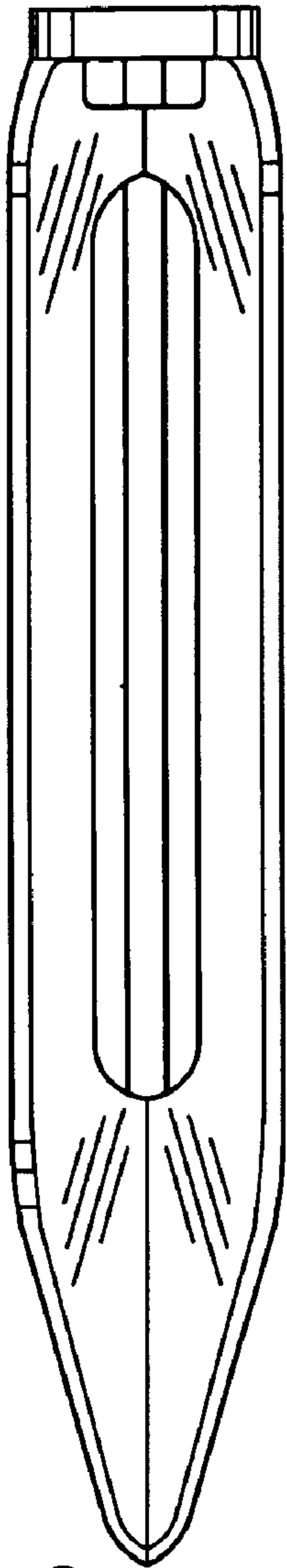

FIG. 2

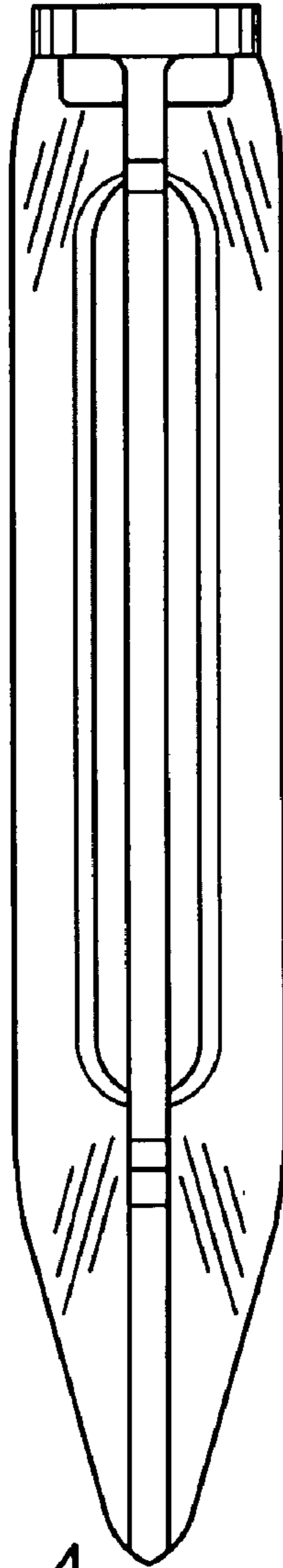

FIG. 4

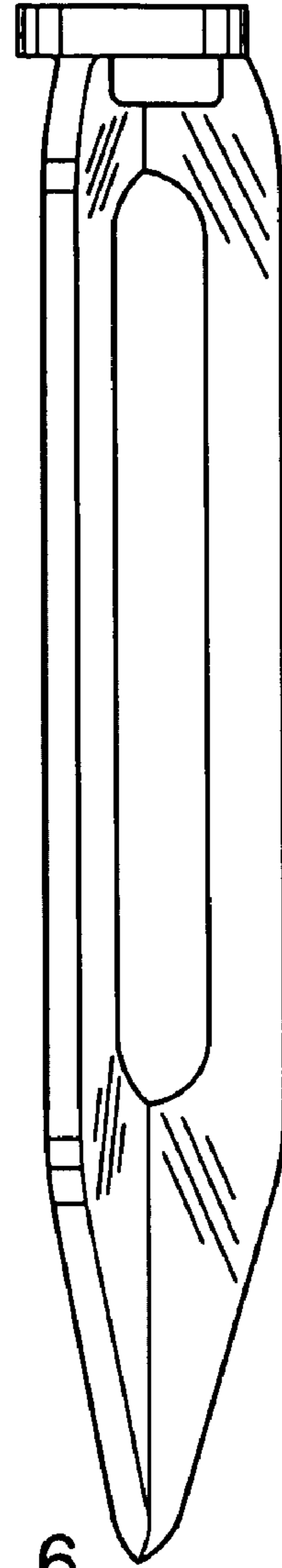

FIG. 6

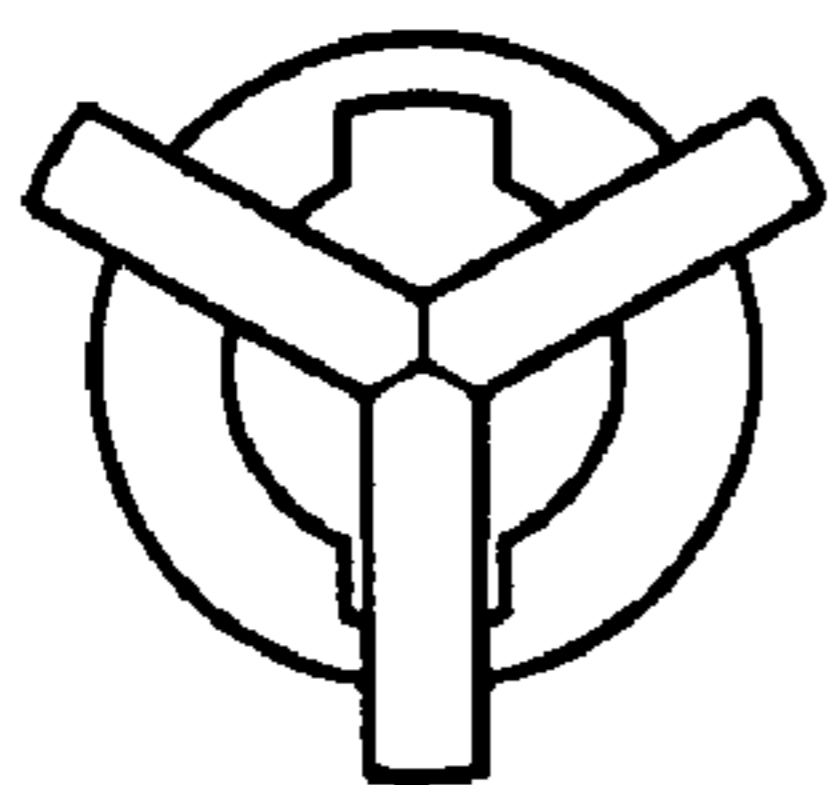

FIG. 3

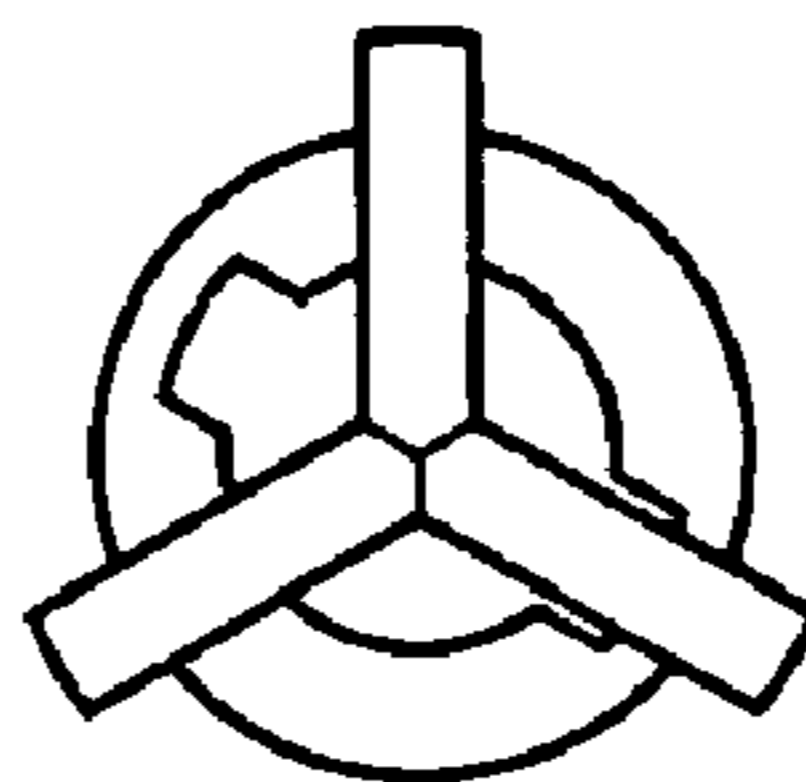

FIG. 5

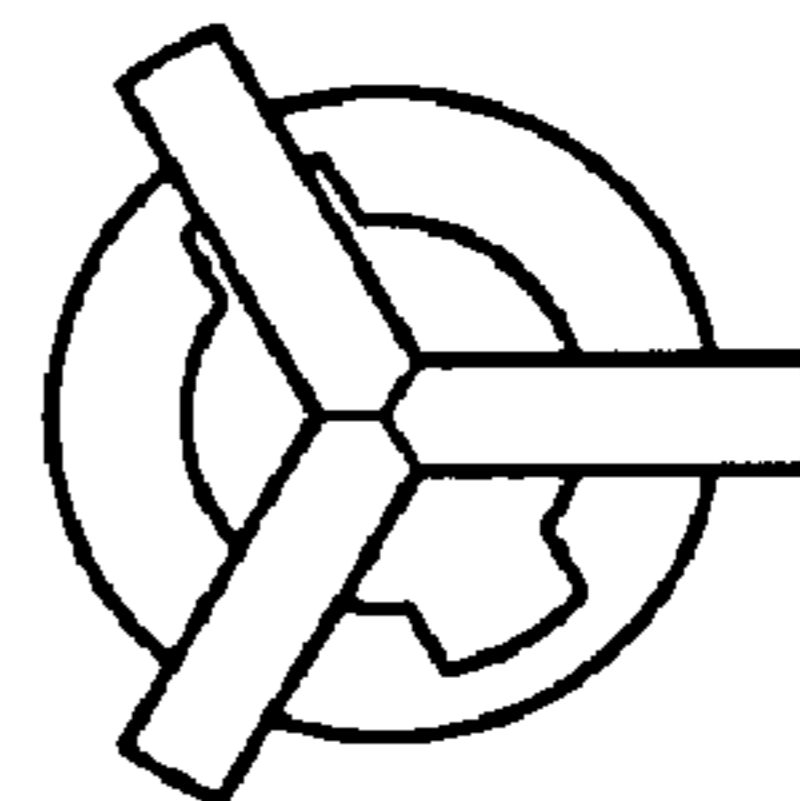

FIG. 7

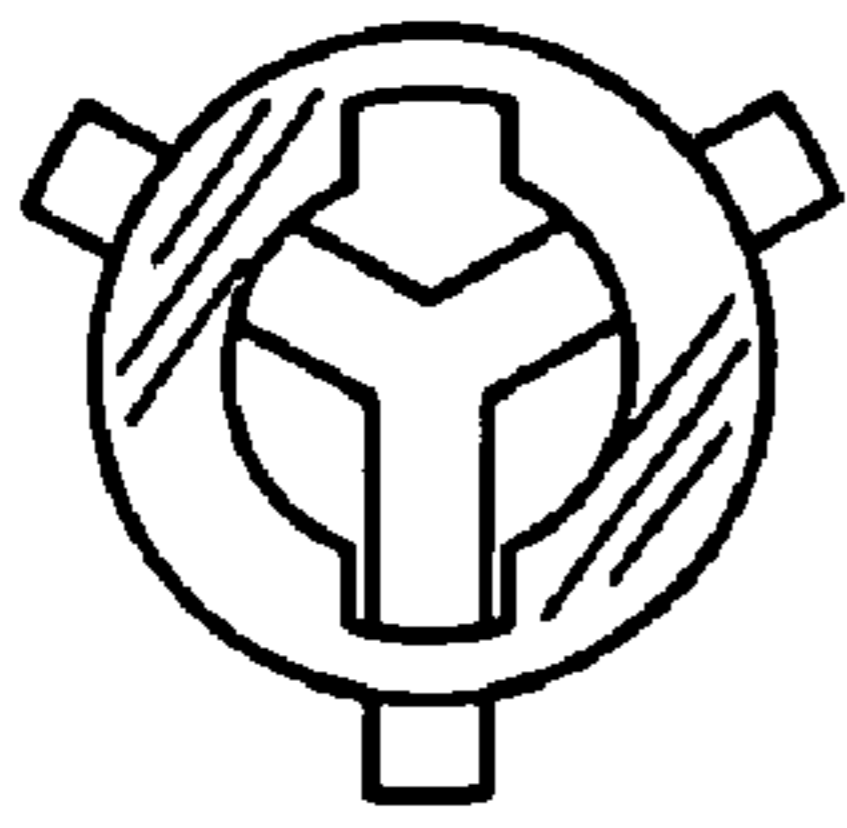

FIG. 8

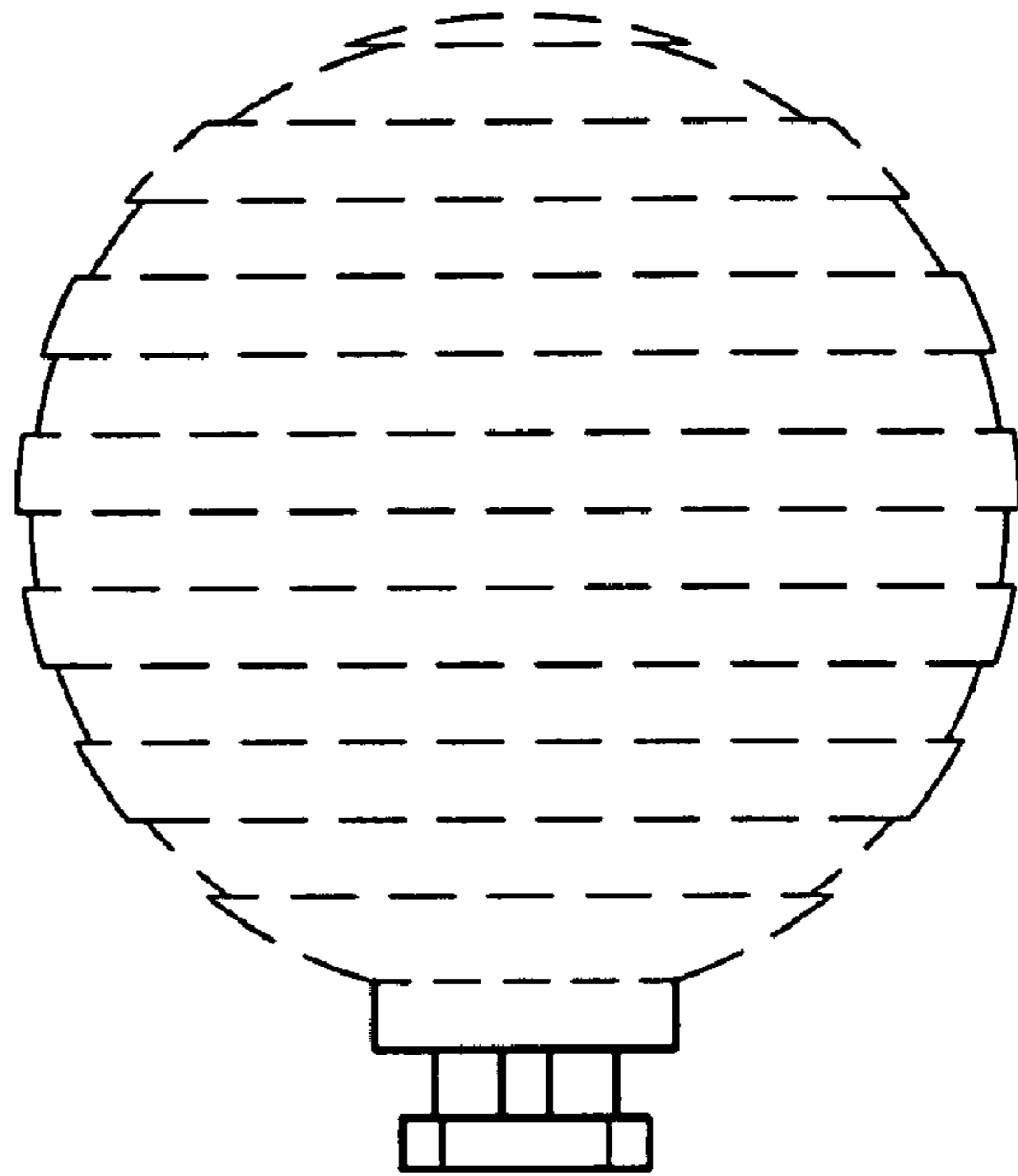

FIG. 9

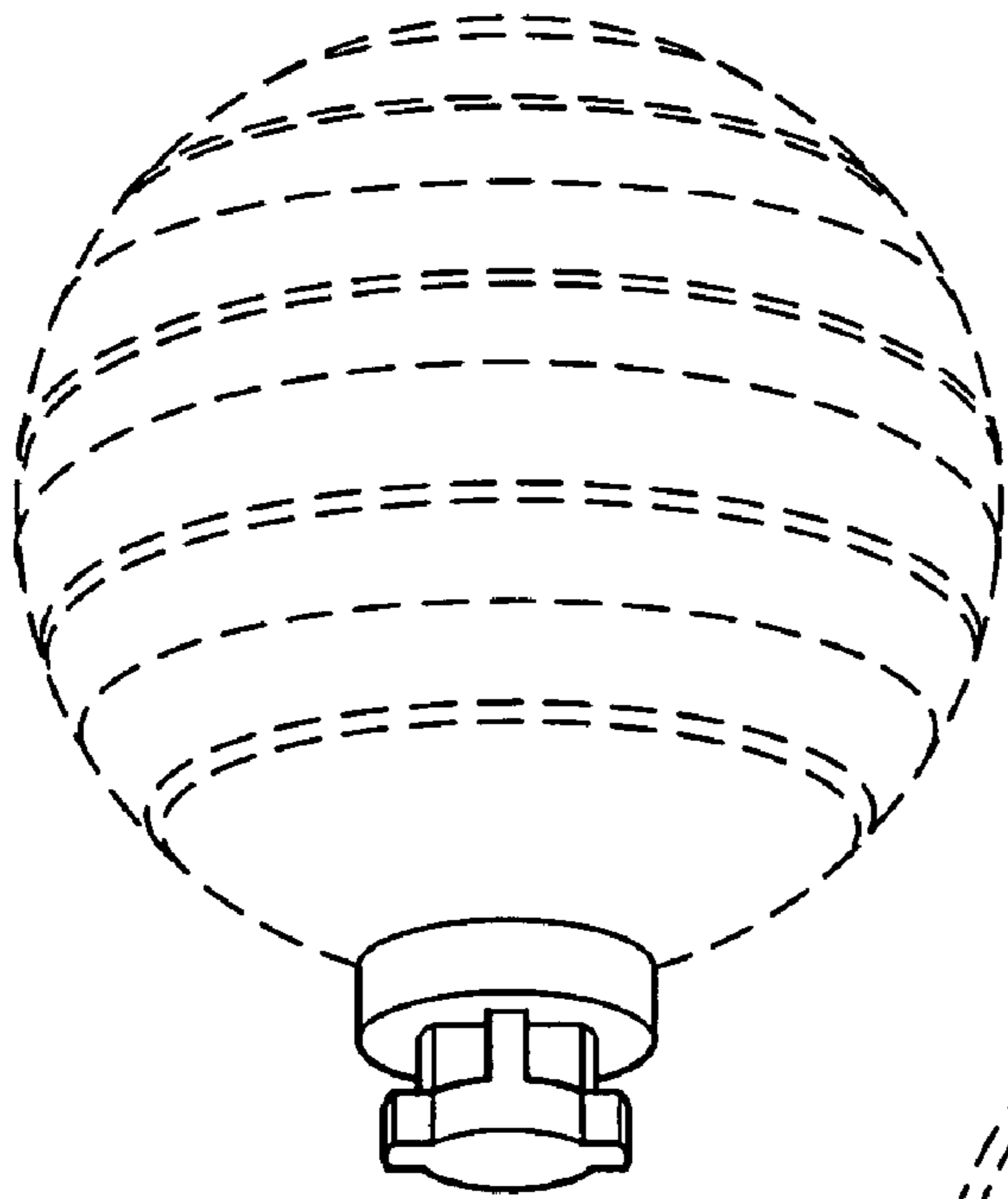

FIG. 11

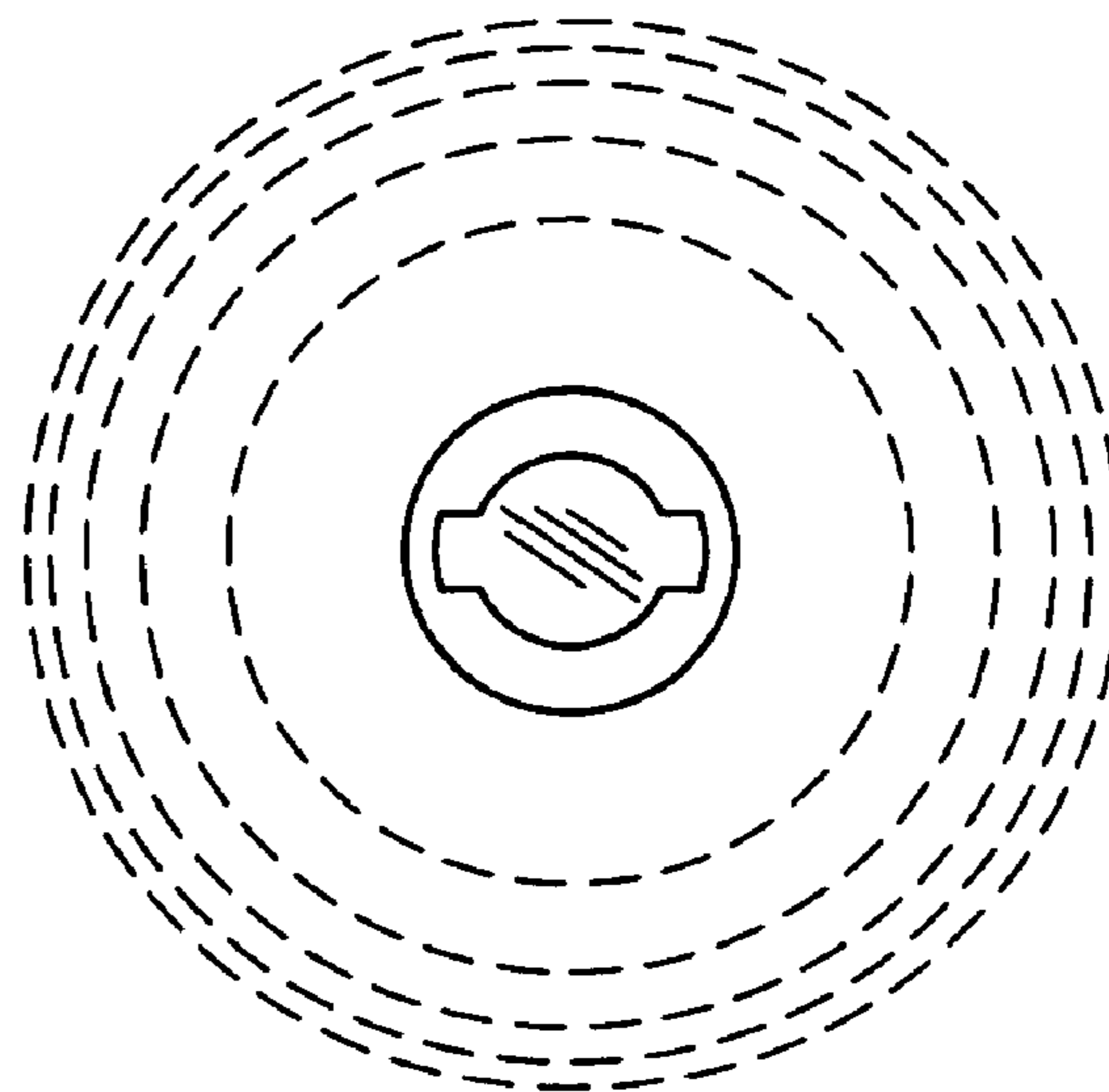

FIG. 10

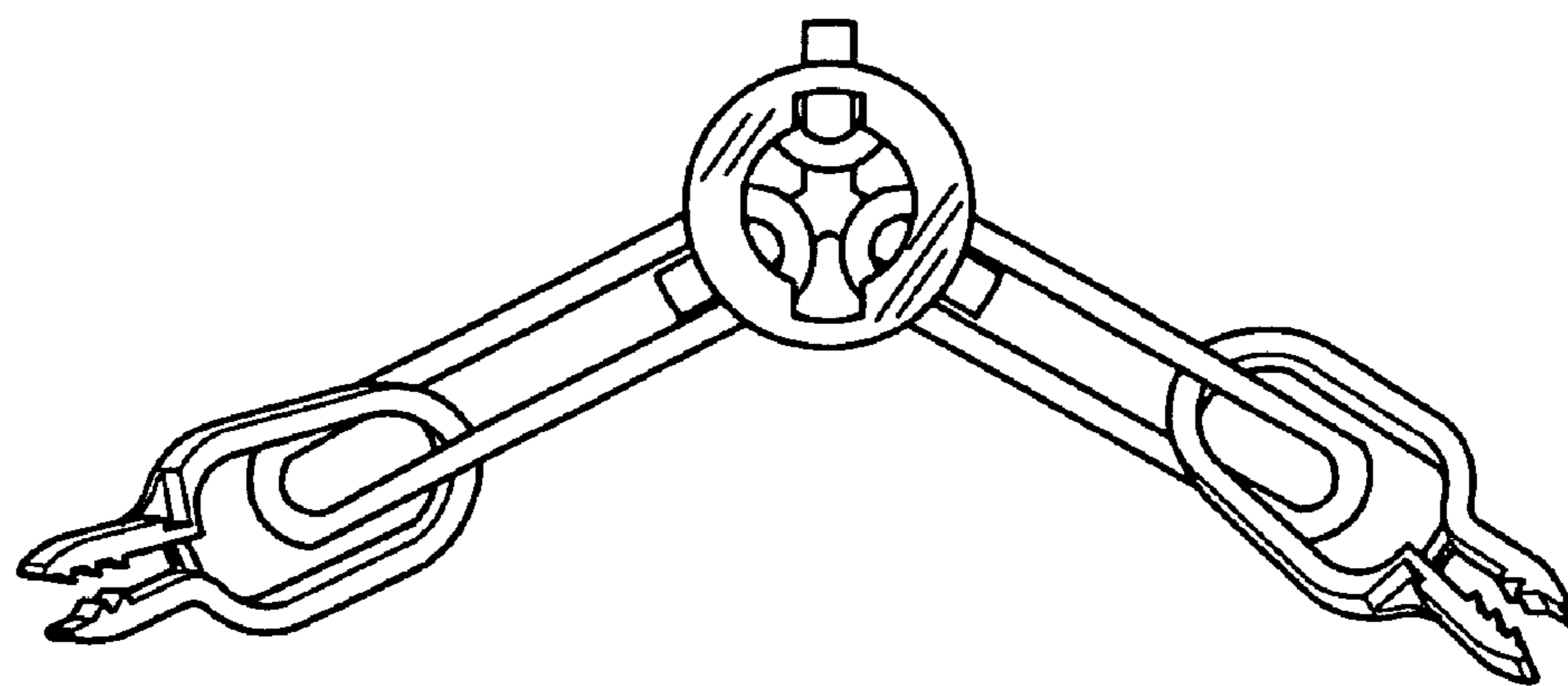

FIG. 12

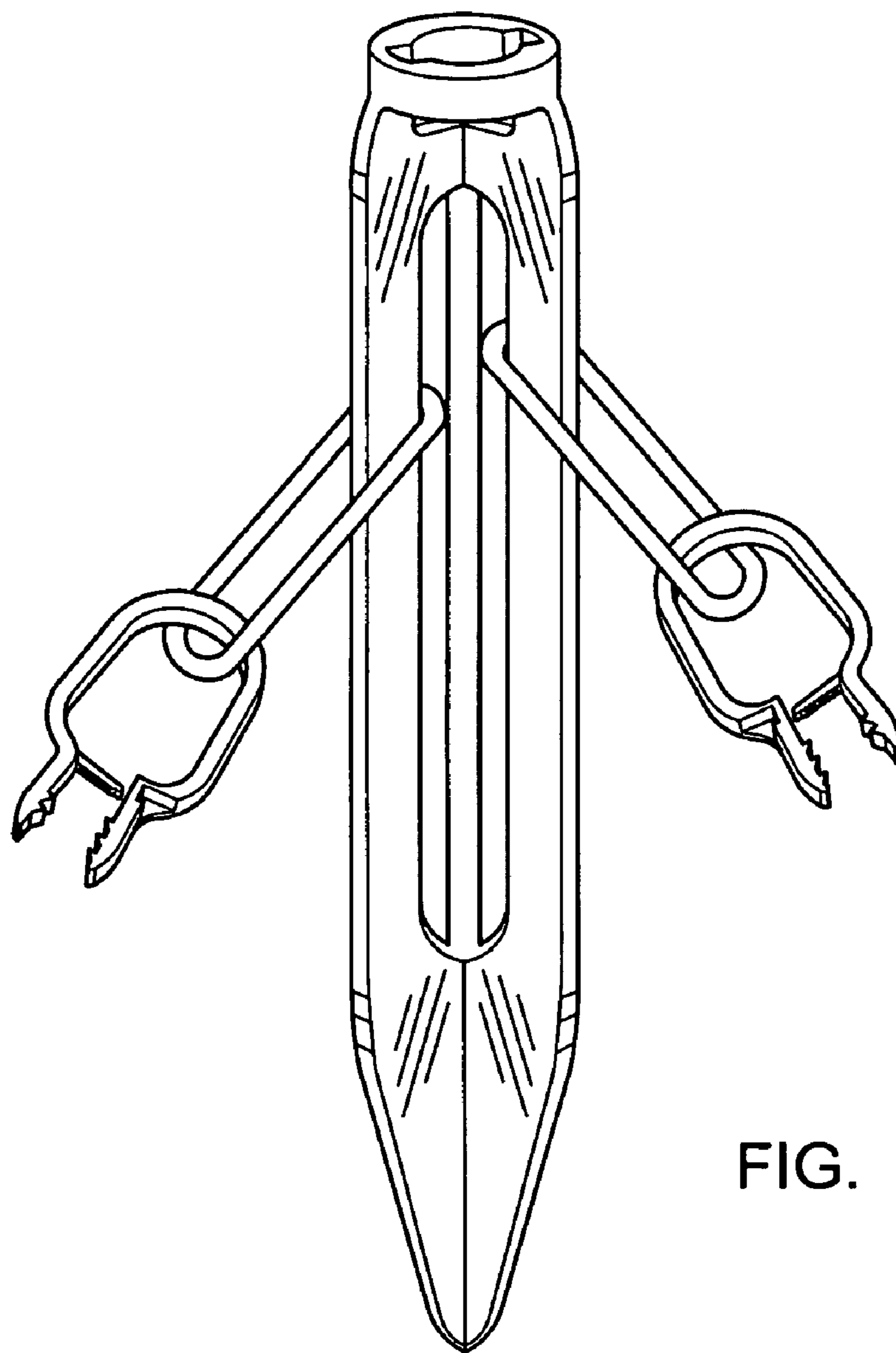

FIG. 13