



US00D604992S

(12) **United States Design Patent**
Klein

(10) **Patent No.:** **US D604,992 S**

(45) **Date of Patent:** **** Dec. 1, 2009**

(54) **MICROWAVABLE FOOD CONTAINER WITH
REMOVABLE COMPARTMENTS**

(76) **Inventor:** **Raymond F. Klein**, 6349 Chapel Pines
Blvd., Wesley Chapel, FL (US) 33545

(**) **Term:** **14 Years**

(21) **Appl. No.:** **29/337,911**

(22) **Filed:** **Jun. 1, 2009**

(51) **LOC (9) Cl.** **07-01**

(52) **U.S. Cl.** **D7/541; D7/392.1**

(58) **Field of Classification Search** D7/552.2,
D7/741, 739, 737, 759, 761, 424, 425, 426,
D7/553.8, 538, 555, 551.1, 566, 541, 585,
D7/505, 571, 316, 356, 409, 667, 500, 543,
D7/549, 554.3, 553.5, 553.3, 553.2, 553.1,
D7/550, 614, 703, 629, 357, 550.1, 553.7;
D3/315; D28/61; D9/666; 99/341; 220/575,
220/23.86, 23.4; 229/406; 206/583, 532
See application file for complete search history.

(56) **References Cited**

U.S. PATENT DOCUMENTS

261,811	A *	7/1882	Coues	220/575
3,101,864	A *	8/1963	Glickman	206/557
3,244,537	A *	4/1966	Cease	426/393
3,247,988	A *	4/1966	Cease	414/405
D214,523	S	6/1969	Stone	
3,501,044	A	3/1970	Stone	
3,595,425	A *	7/1971	Eicholtz et al.	220/556
4,574,174	A *	3/1986	McGonigle	219/735
4,741,441	A	5/1988	Keffeler	

(Continued)

Primary Examiner—Robert M Spear

Assistant Examiner—Cynthia Underwood

(74) *Attorney, Agent, or Firm*—QuickPatents, Inc.; Kevin Prince

(57) **CLAIM**

I claim the ornamental design for a microwavable food container with removable compartments, as shown and described.

DESCRIPTION

FIG. 1 is an exploded top perspective view of my new design;

FIG. 2 is an exploded bottom perspective view thereof;

FIG. 3 is a front elevational view of a tray thereof;

FIG. 4 is a rear elevational view thereof;

FIG. 5 is a left-side elevational view thereof, the right-side elevational view being a mirror image thereof;

FIG. 6 is a top plan view thereof;

FIG. 7 is a bottom plan view thereof;

FIG. 8 is a front elevational view of a first removable compartment of the design, the front elevational view of a second removable compartment of the design being a mirror image thereof;

FIG. 9 is a rear elevational view thereof, the rear elevational view of the second removable compartment being a mirror image thereof;

FIG. 10 is a right-side elevational view thereof, the right-side elevational view of the second removable compartment being a mirror image thereof;

FIG. 11 is a left-side elevational view thereof, the left-side elevational view of the second removable compartment being a mirror image thereof;

FIG. 12 is a top plan view thereof, the top plan view of the second removable compartment being a mirror image thereof;

FIG. 13 is a bottom plan view thereof, the bottom plan view of the second removable compartment being a mirror image thereof;

FIG. 14 is a front elevational view of a cover of the design, the rear elevational view, left-side elevational view, and right-side elevational view all being a mirror image thereof;

FIG. 15 is a top plan view thereof; and,

FIG. 16 is a bottom plan view thereof.

1 Claim, 4 Drawing Sheets

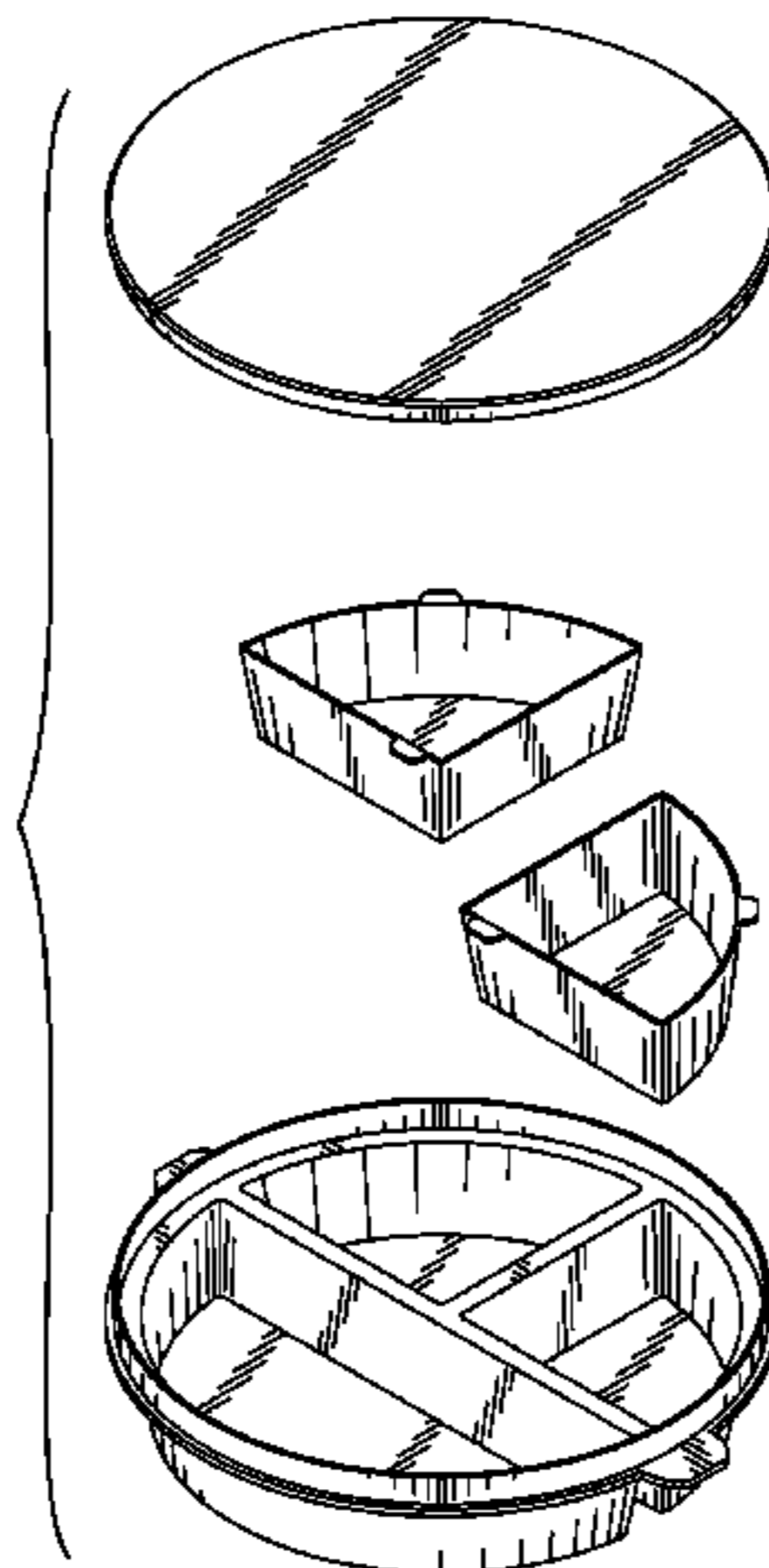

US D604,992 S

Page 2

U.S. PATENT DOCUMENTS

5,007,552	A	4/1991	Sage				
5,011,018	A	4/1991	Keffeler				
D318,207	S *	7/1991	Anderson	D7/549		
5,167,973	A *	12/1992	Snyder	426/115		
5,183,159	A	2/1993	Hojnacki				
D339,030	S *	9/1993	Bitel, Sr.	D7/549		
D352,203	S	11/1994	Campbell				
5,386,922	A	2/1995	Jordan				
D376,953	S *	12/1996	Dunn	D7/549		
5,579,941	A	12/1996	Romick				
5,727,679	A *	3/1998	Newarski	206/222		
D428,767	S	8/2000	Turner, Jr.				
D436,854	S *	1/2001	Feldmeier	D9/434		
6,269,964	B1	8/2001	Turner, Jr.				
D451,018	S *	11/2001	Chen et al.	D9/428		
D459,144	S *	6/2002	Brady	D7/354		
D489,579	S *	5/2004	Wright	D7/629		
D494,857	S *	8/2004	Chen et al.	D9/759		
D552,487	S *	10/2007	Chou	D9/737		
7,337,943	B2	3/2008	Johns				
D568,111	S	5/2008	Epstein				
D573,409	S *	7/2008	Lovett	D7/553.3		
D575,582	S	8/2008	Geens				
D586,623	S *	2/2009	Dunn	D7/541		

* cited by examiner

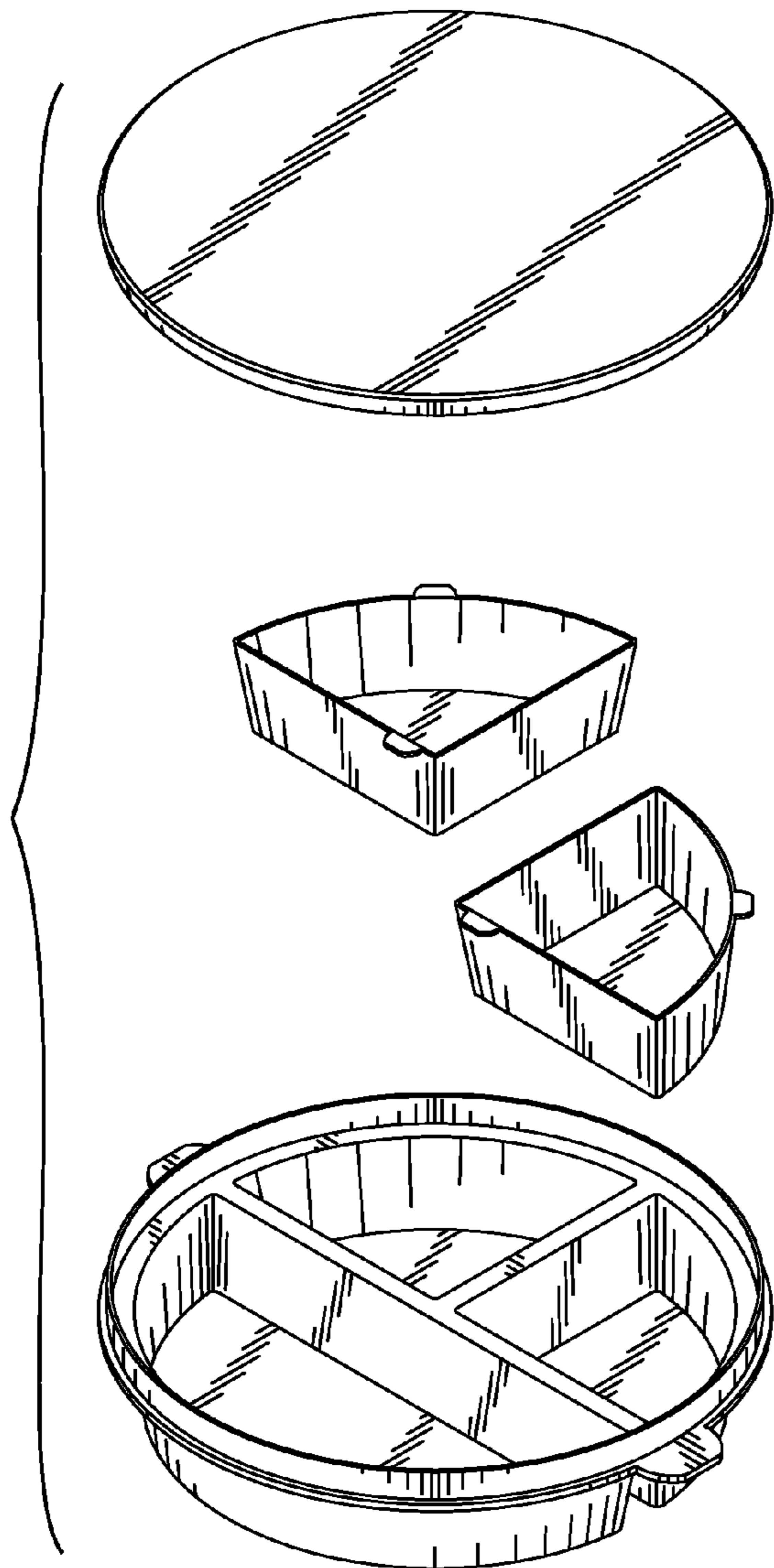

FIG. 1

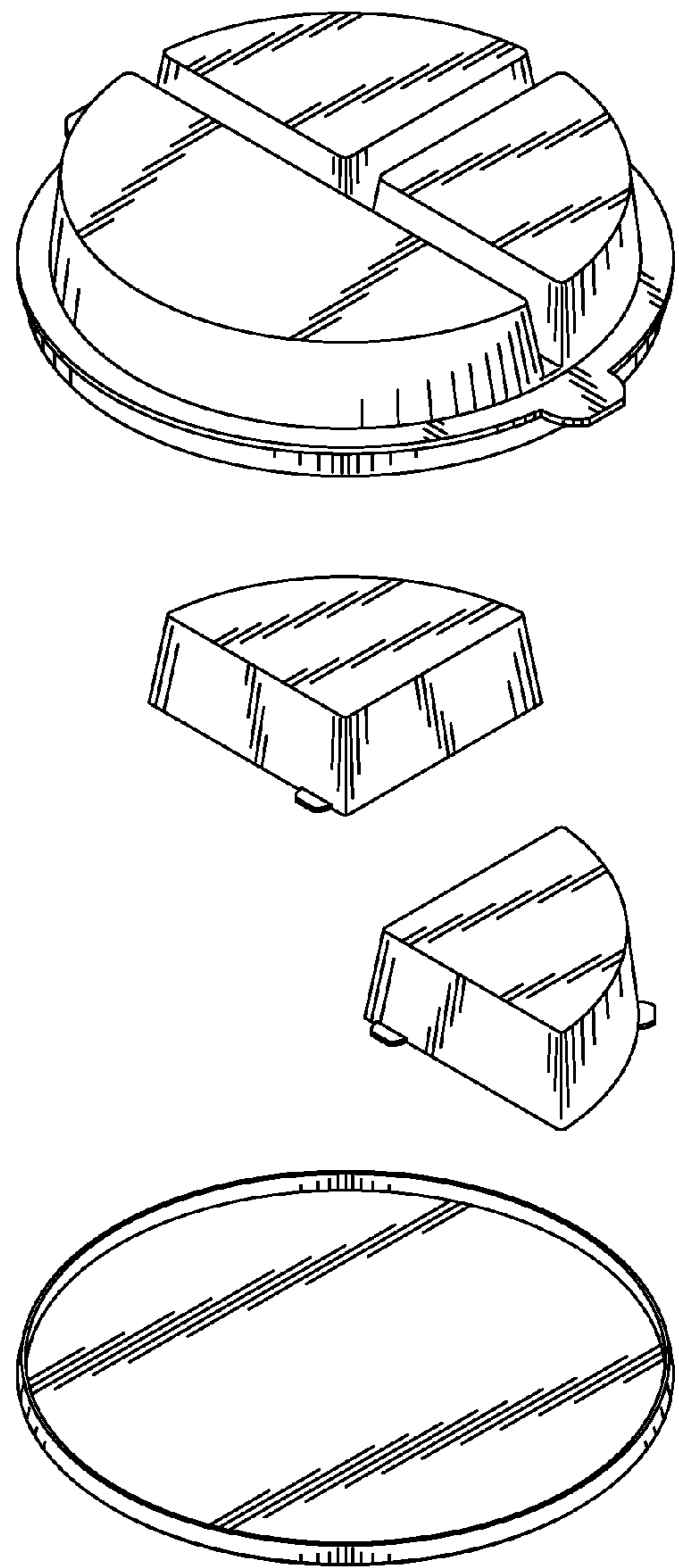

FIG. 2

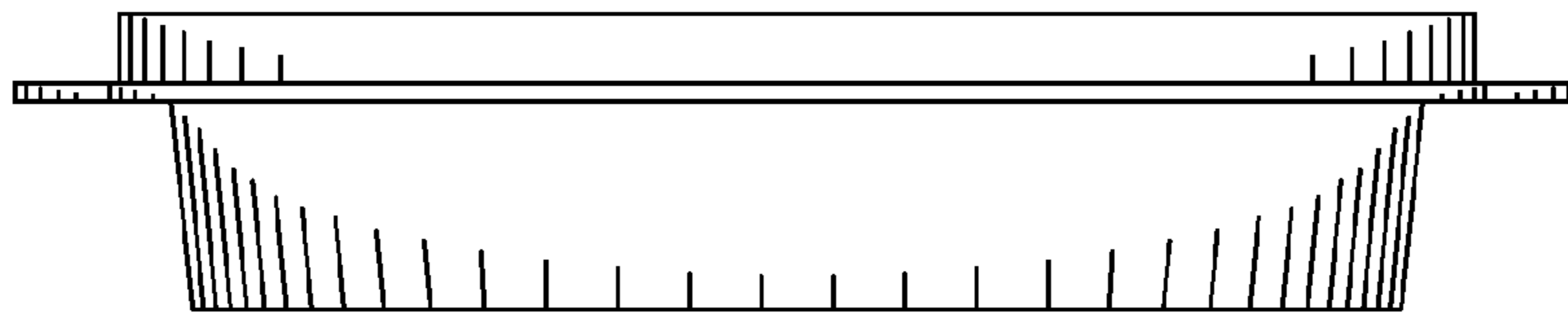

FIG. 3

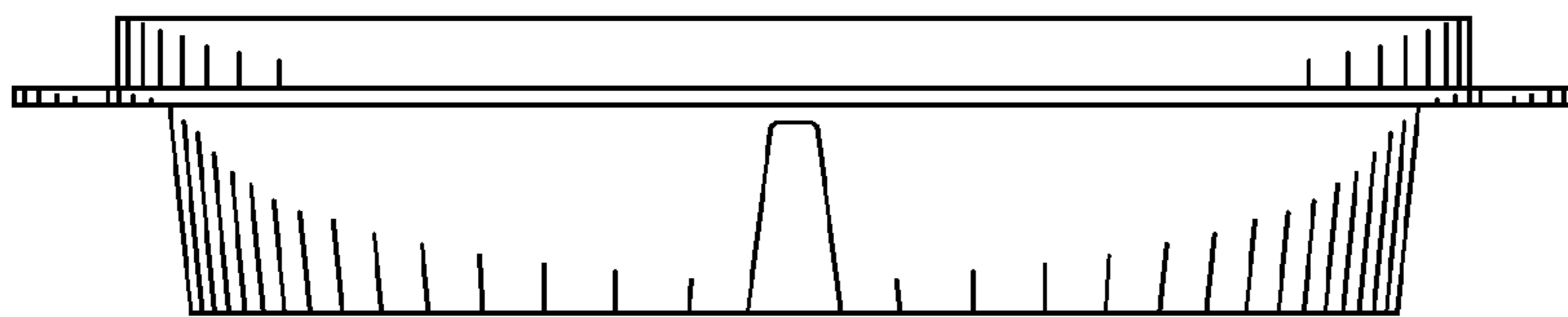

FIG. 4

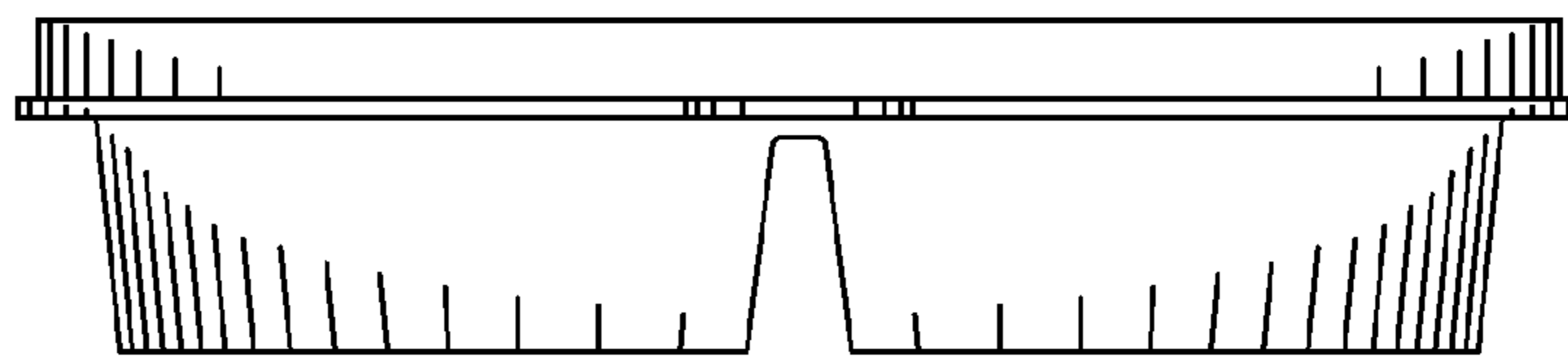

FIG. 5

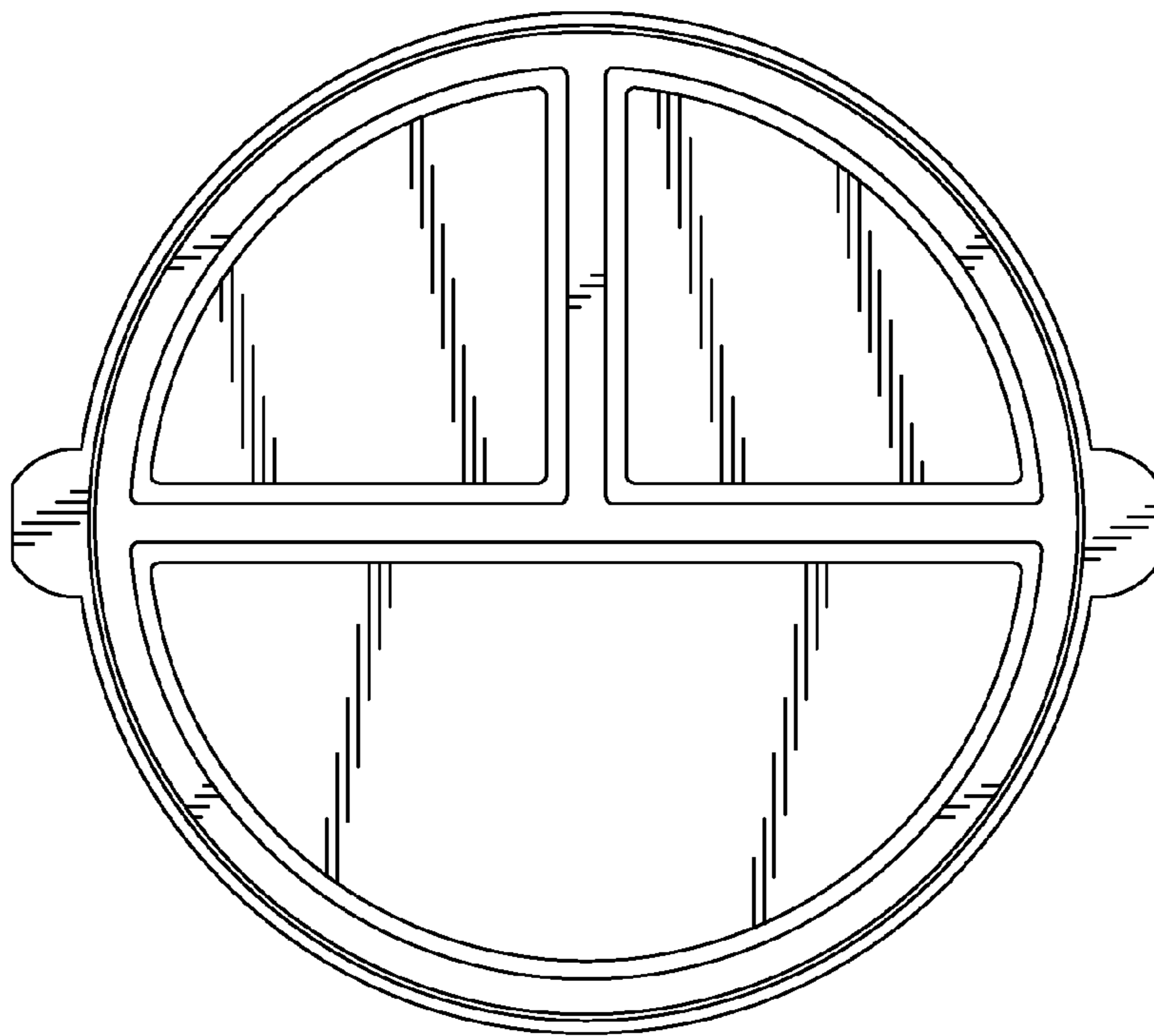

FIG. 6

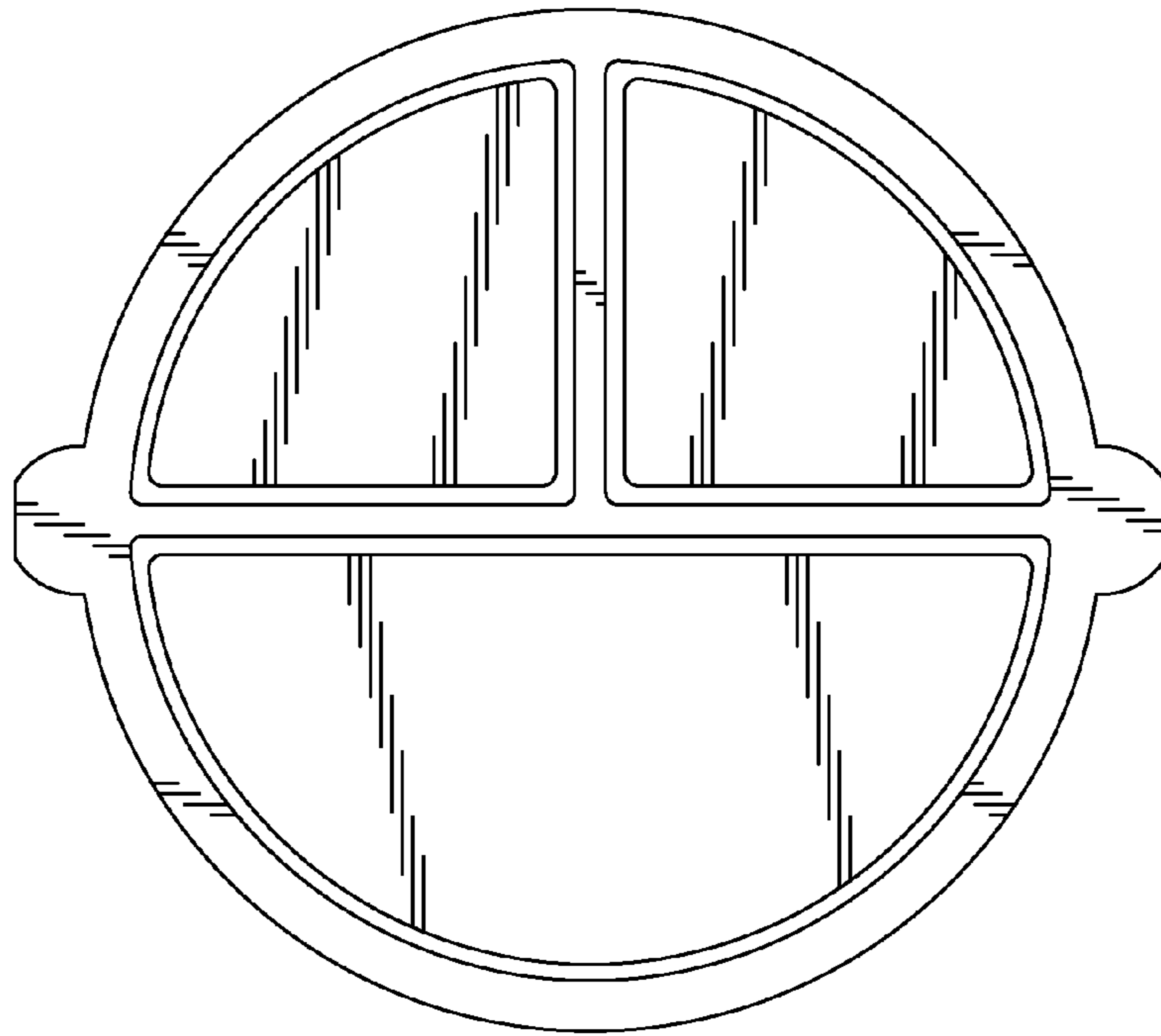

FIG. 7

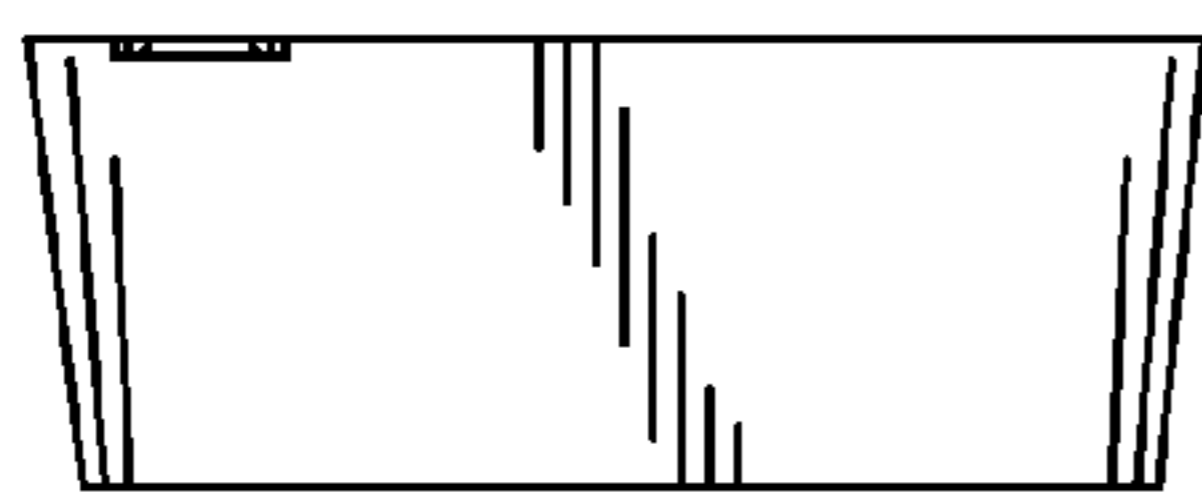

FIG. 8

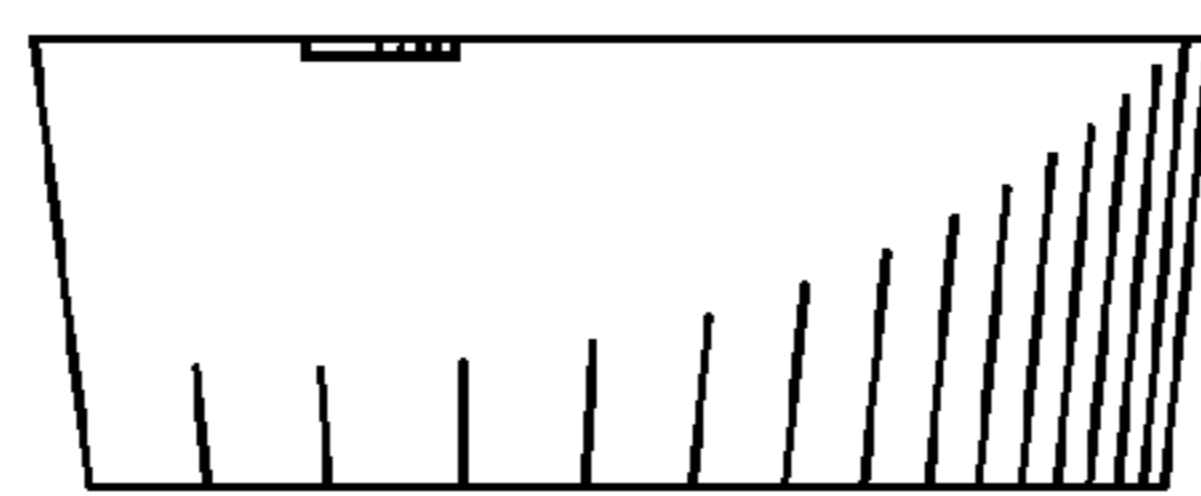

FIG. 9

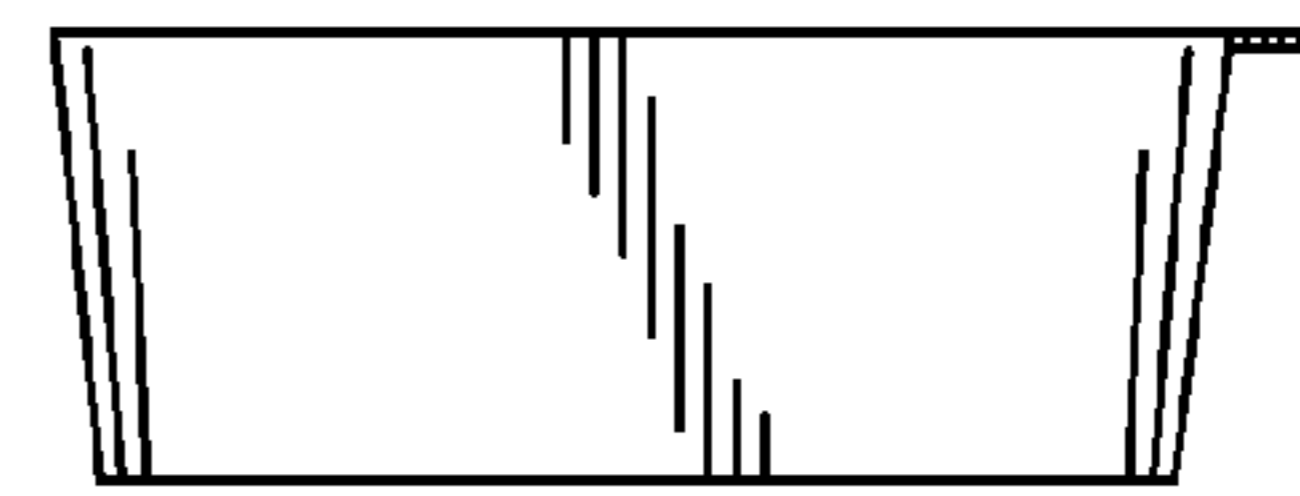

FIG. 10

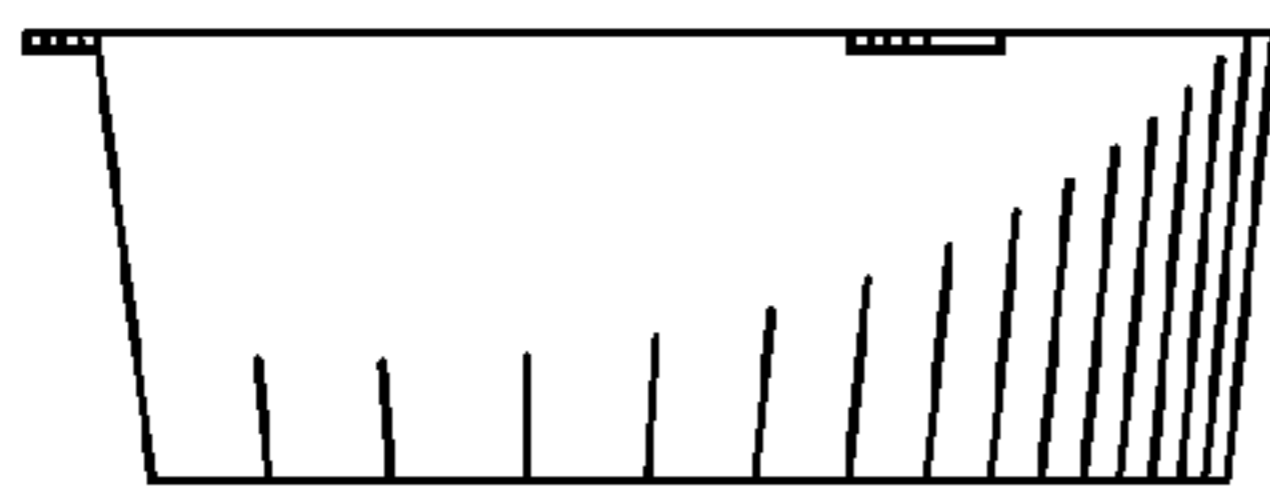

FIG. 11

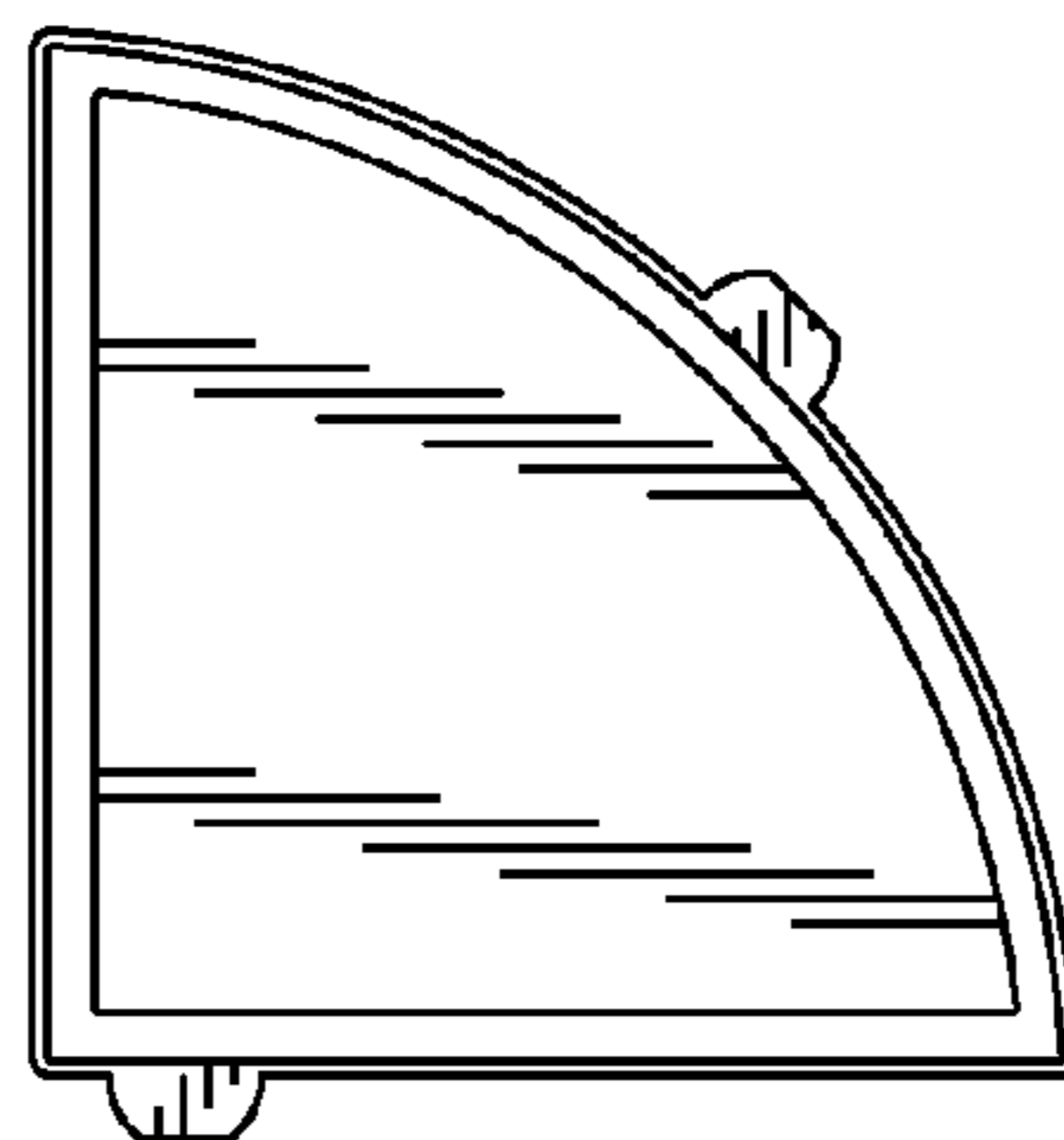

FIG. 12

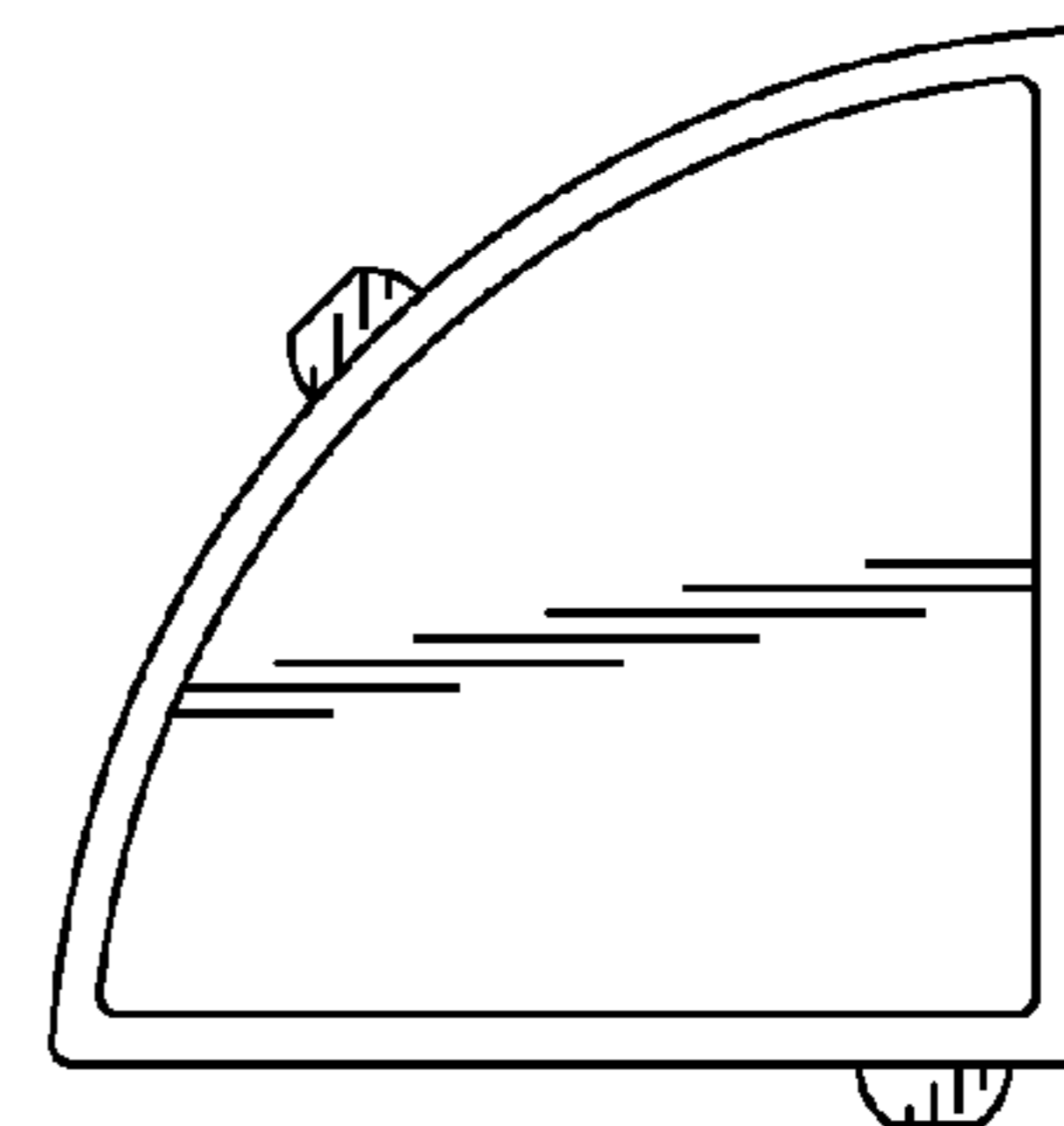

FIG. 13

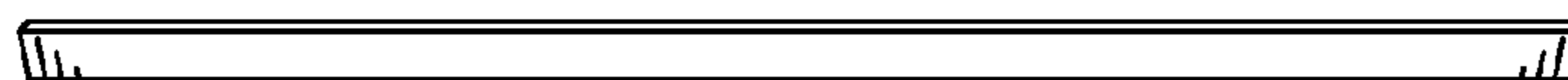

FIG. 14

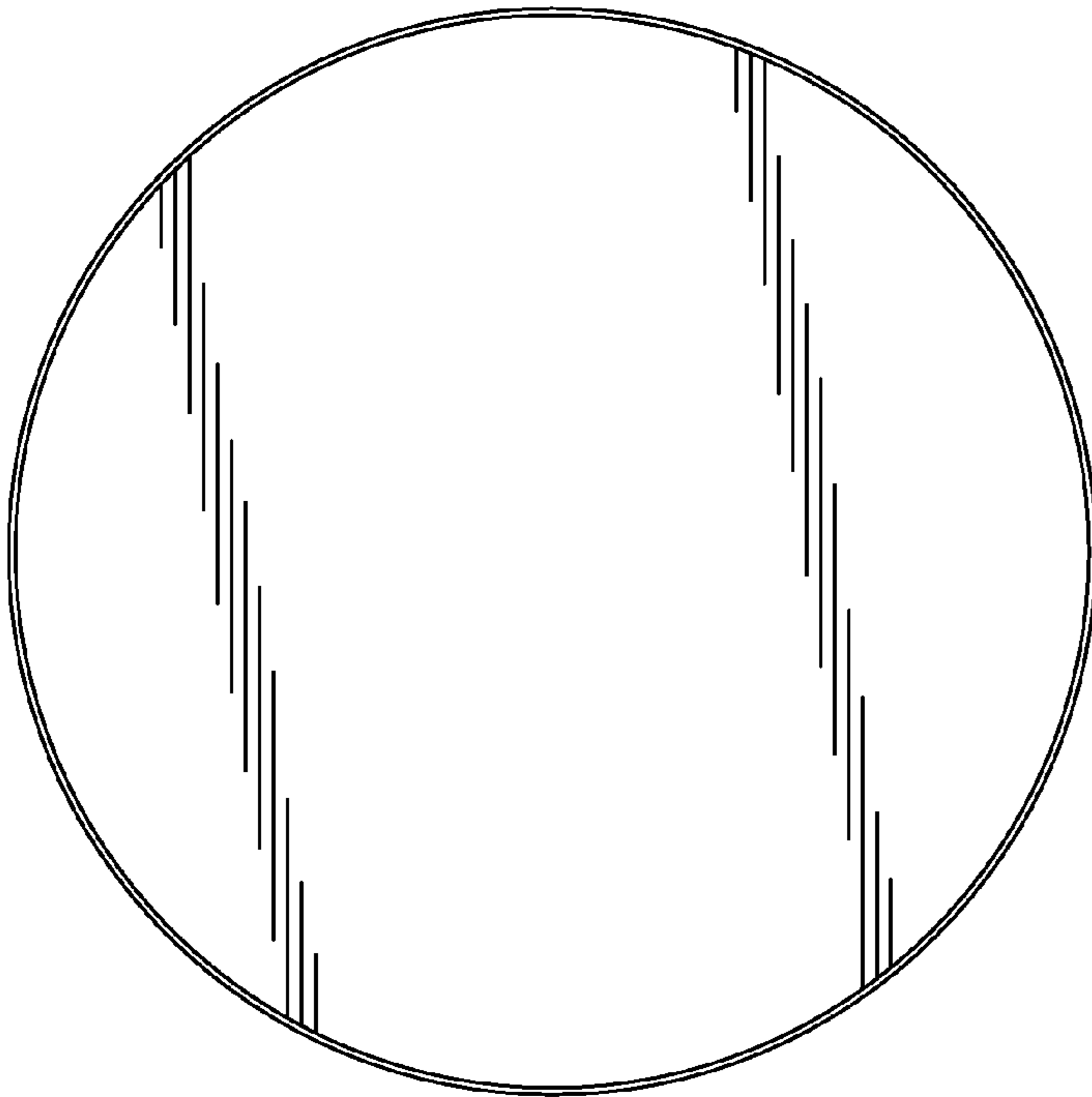

FIG. 15

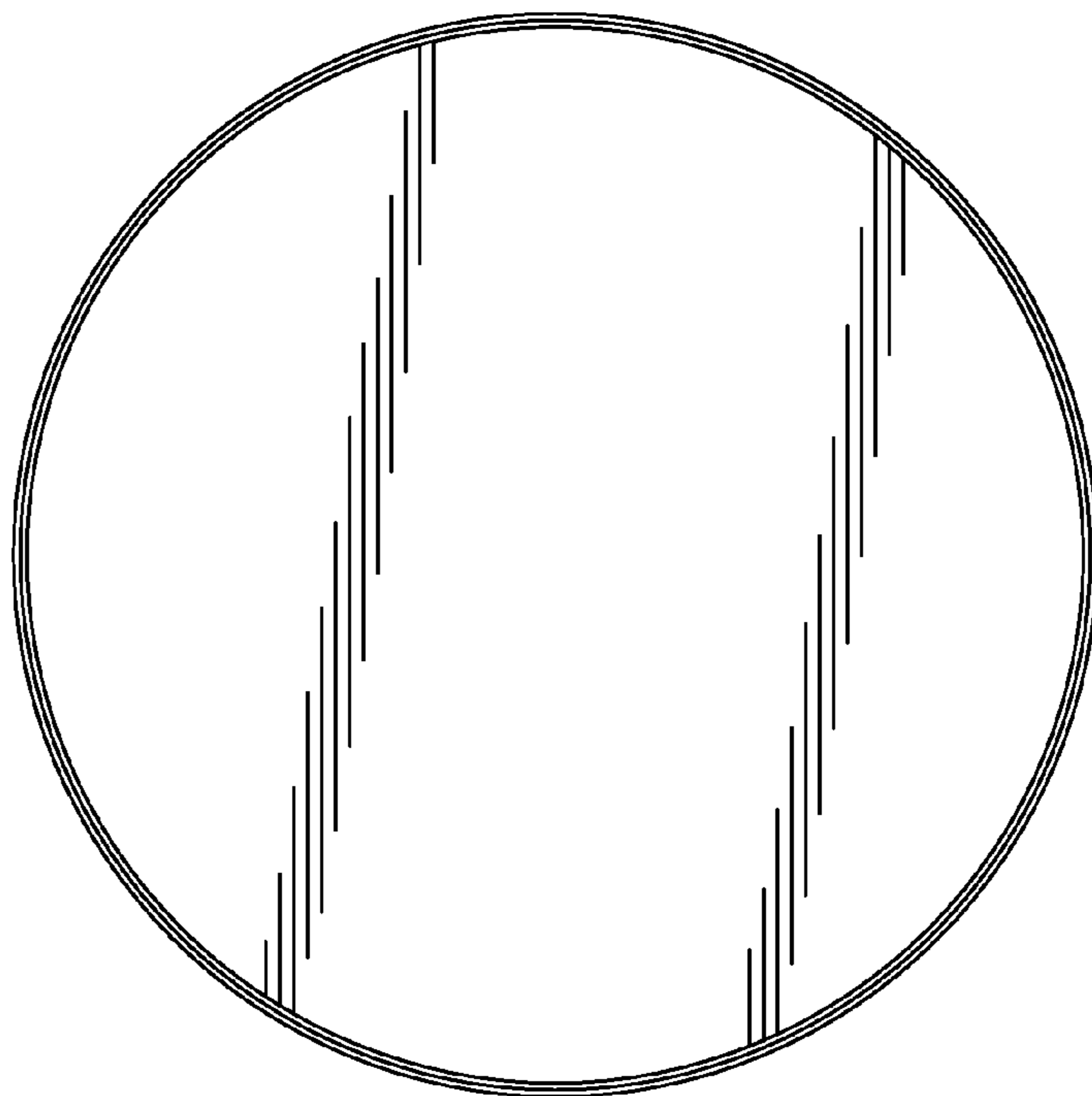

FIG. 16