



US00D604907S

(12) **United States Design Patent**
Emminger

(10) **Patent No.:** **US D604,907 S**
(45) **Date of Patent:** **** Nov. 24, 2009**

(54) **HAIR CUTTING MACHINE**

(75) Inventor: **Gerd Emminger**, Niedereschach (DE)

(73) Assignee: **WAHL GmbH**, Unterkirnach (DE)

(**) Term: **14 Years**

(21) Appl. No.: **29/314,108**

(22) Filed: **Mar. 4, 2009**

Related U.S. Application Data

(62) Division of application No. 29/310,171, filed on Jul. 30, 2008.

Foreign Application Priority Data

(30) Feb. 6, 2008 (EM) 000 873 880

(51) **LOC (9) Cl.** **28-03**

(52) **U.S. Cl.** **D28/53**

(58) **Field of Classification Search** D28/49-54;
30/32, 34.05, 34.1, 34.2, 35, 41.9, 43, 43.1-43.92,
30/42.44-46, 527, 196, 201, 233, 223, 233.5
See application file for complete search history.

(56) **References Cited**

U.S. PATENT DOCUMENTS

- D310,734 S * 9/1990 Gallanis D28/53
- D405,924 S * 2/1999 Lebherz D28/53
- D435,694 S * 12/2000 Lebherz D28/53
- D436,229 S * 1/2001 Eguchi et al. D28/53
- D455,864 S * 4/2002 Rizzuto et al. D28/53
- D456,096 S * 4/2002 Rizzuto et al. D28/53

- D462,482 S * 9/2002 Rizzuto et al. D28/53
- D466,650 S * 12/2002 Muller et al. D28/53
- D490,934 S * 6/2004 Graf D28/53
- D493,573 S * 7/2004 Graf D28/53
- D586,955 S * 2/2009 Eigenstetter et al. D28/53

FOREIGN PATENT DOCUMENTS

WO DM/048277 5/1999

* cited by examiner

Primary Examiner—Jennifer Rivard

(74) *Attorney, Agent, or Firm*—Muirhead and Saturnelli, LLC

(57) **CLAIM**

The ornamental design for a hair cutting machine, as shown and described.

DESCRIPTION

FIG. 1 is a front perspective view showing the new design according to an embodiment;

FIG. 2 is a right elevational view thereof;

FIG. 3 is a rear elevational view thereof;

FIG. 4 is a front elevational view thereof;

FIG. 5 is a left elevational view thereof;

FIG. 6 is a top plan view thereof; and,

FIG. 7 is a bottom plan view thereof.

The broken lines shown in the drawings illustrate portions of environmental structure and form no part of the claimed design.

1 Claim, 7 Drawing Sheets

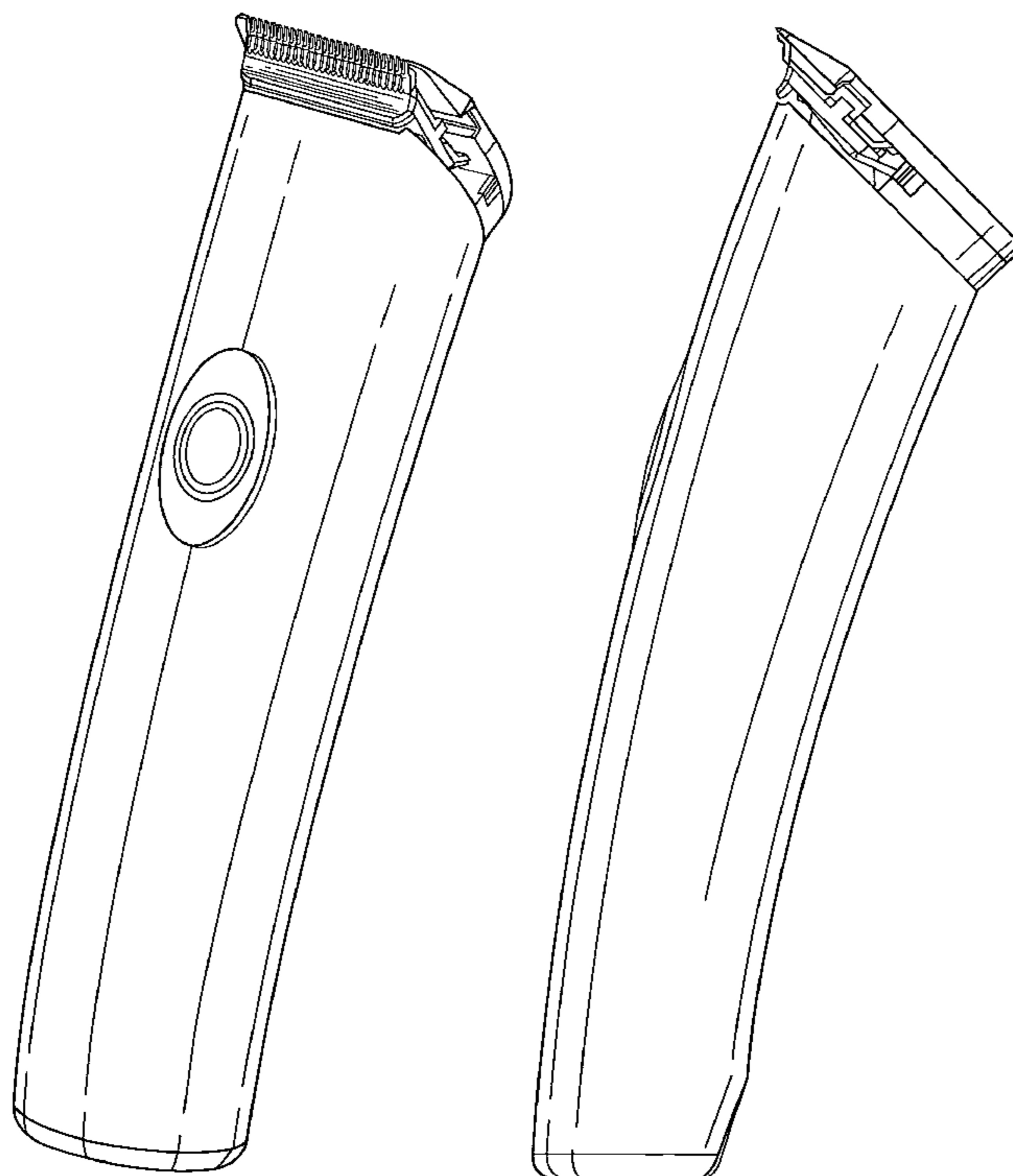

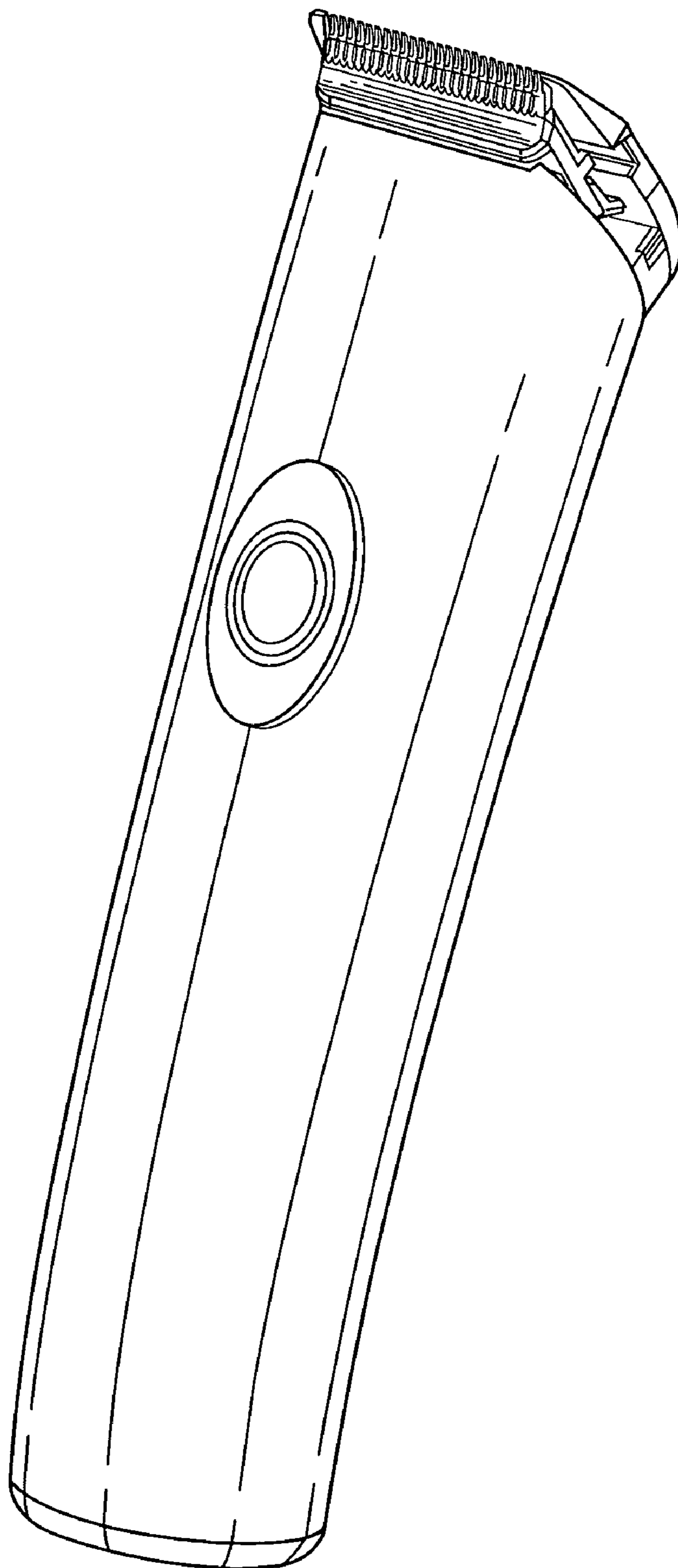

FIG. 1

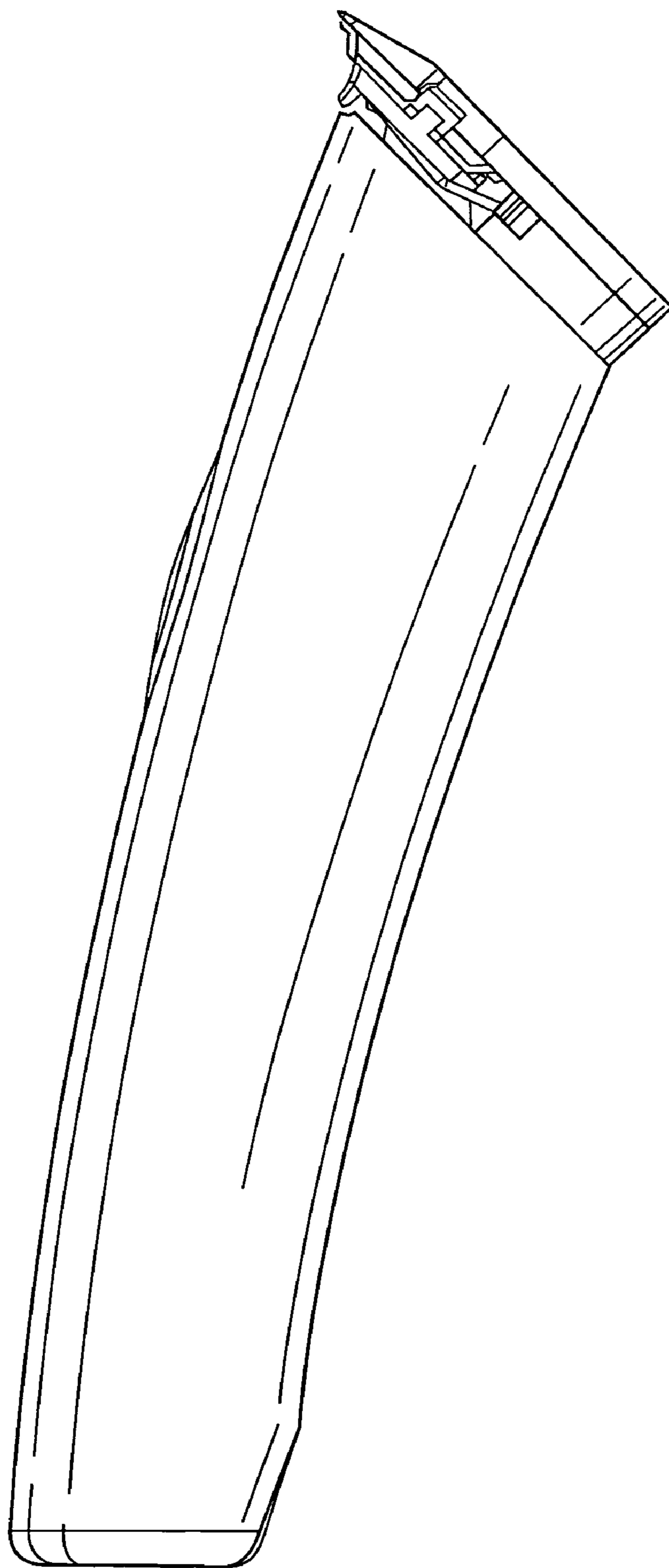

FIG. 2

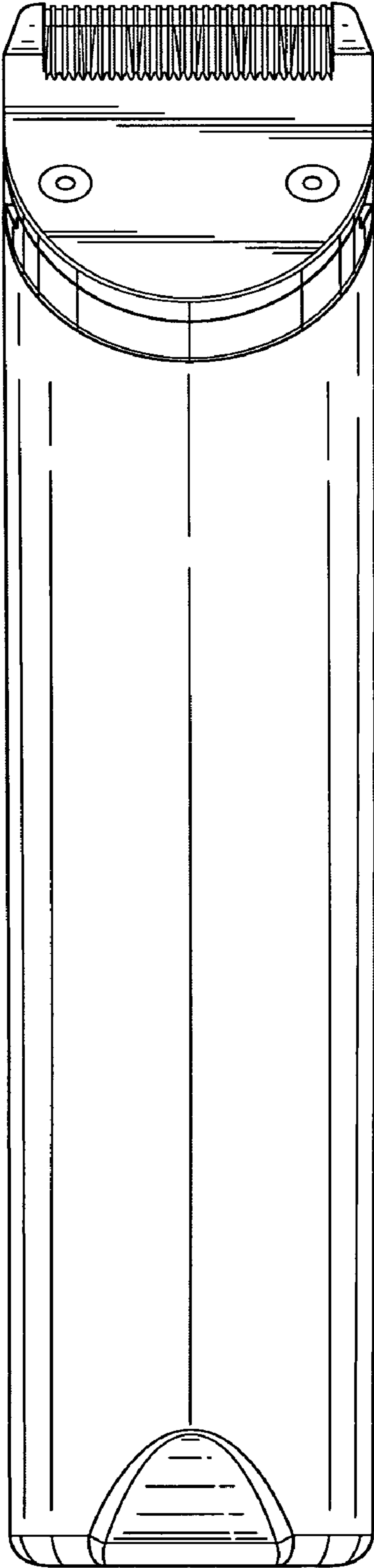

FIG. 3

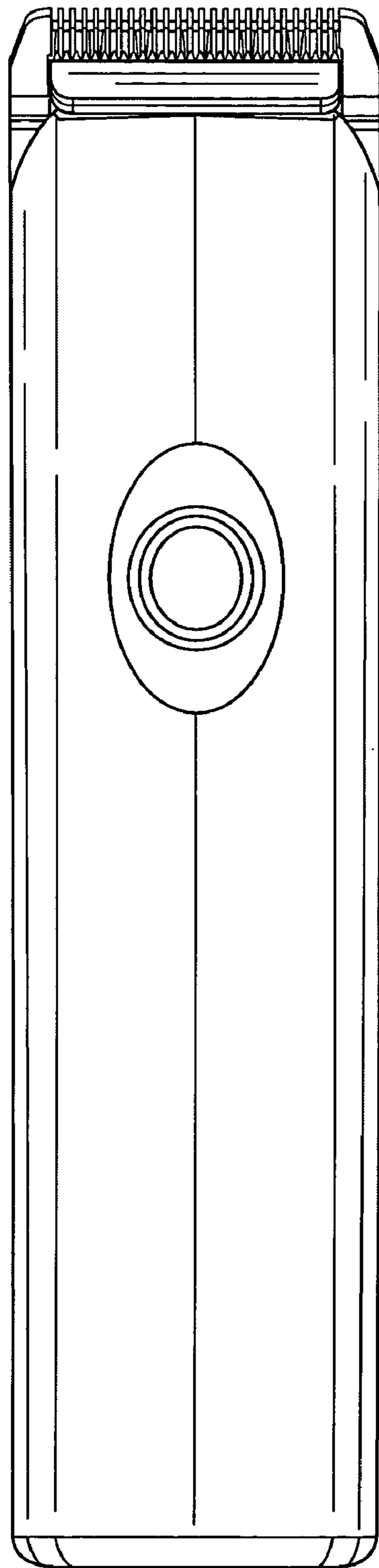

FIG. 4

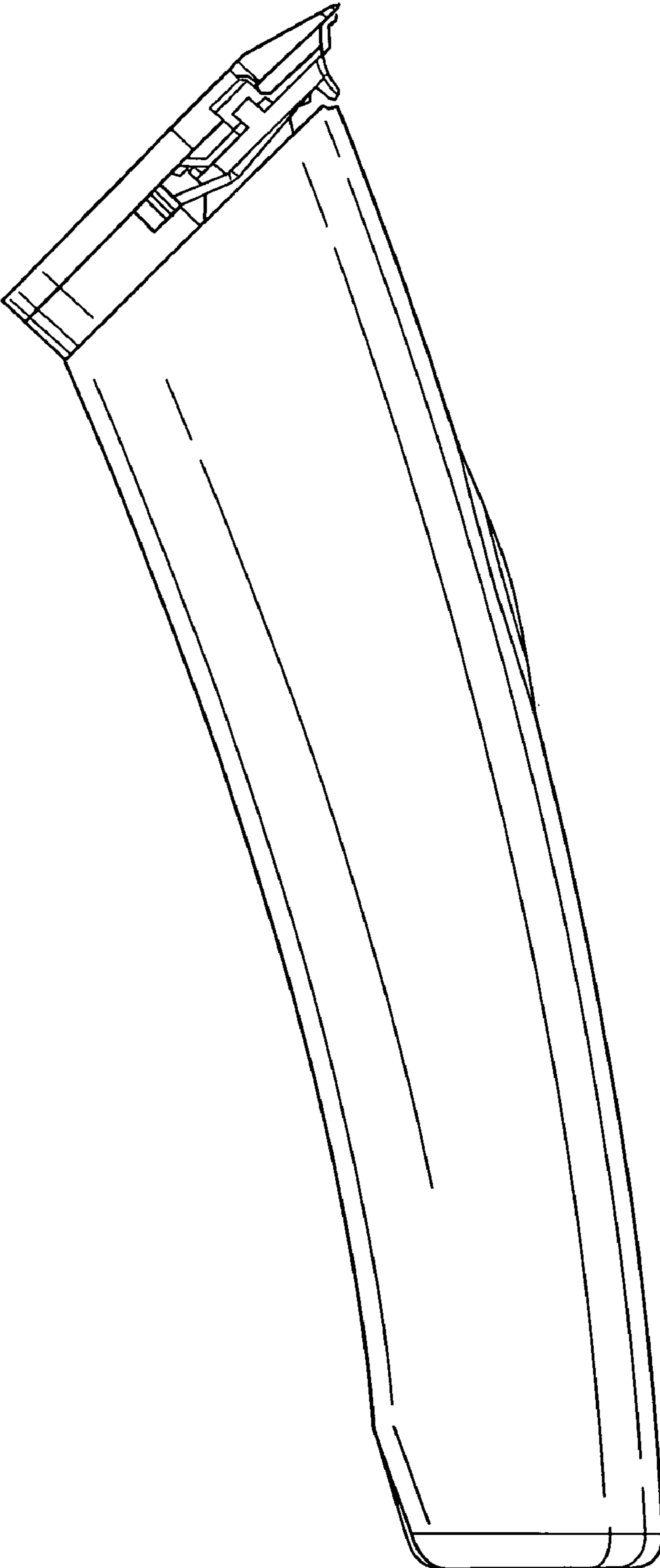

FIG. 5

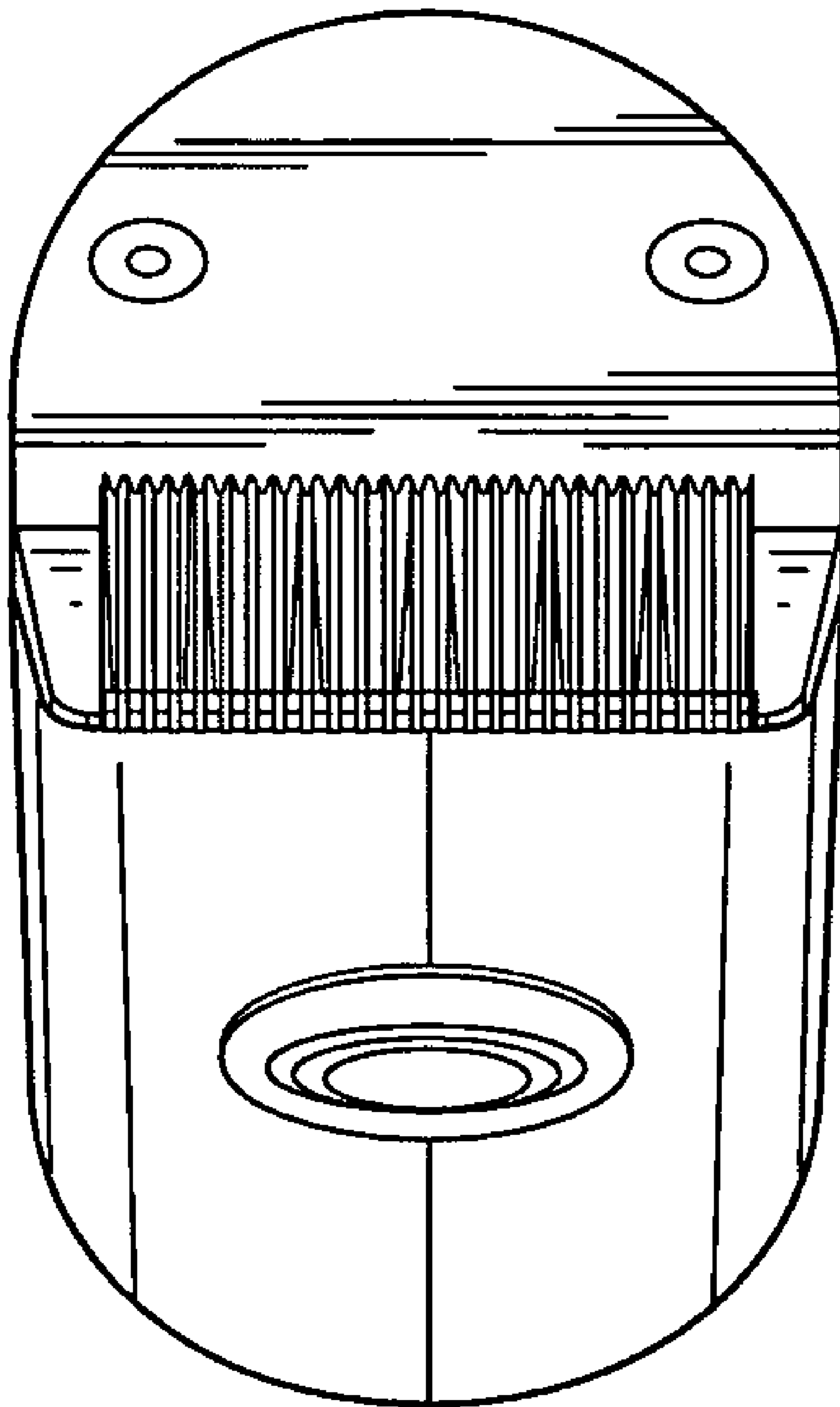

FIG. 6

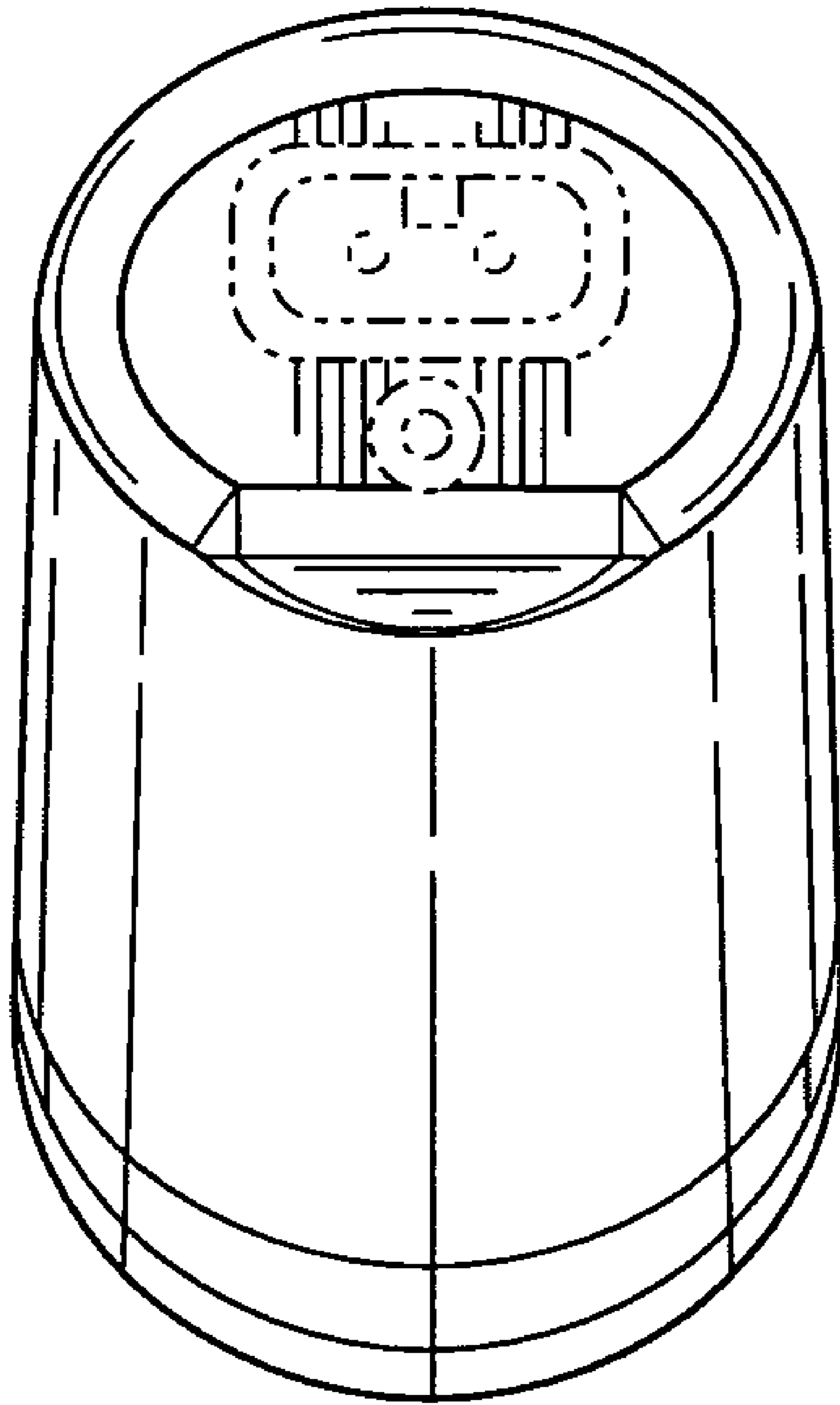

FIG. 7