



US00D604787S

(12) **United States Design Patent**
Hopkins

(10) **Patent No.:** **US D604,787 S**

(45) **Date of Patent:** **** Nov. 24, 2009**

(54) **HEAD FOR A TRAINING PUTTER**

(76) Inventor: **David Hopkins**, 269 Litton Ave., Colton, CA (US) 92324

(**) Term: **14 Years**

(21) Appl. No.: **29/314,677**

(22) Filed: **Apr. 17, 2009**

(51) **LOC (9) Cl.** **21-02**

(52) **U.S. Cl.** **D21/791; D21/736**

(58) **Field of Classification Search** D21/736-746, D21/789, 790; 473/324-331, 340-341, 251-256
See application file for complete search history.

(56) **References Cited**

U.S. PATENT DOCUMENTS

D346,842 S *	5/1994	O'Neil	D21/790
D517,143 S *	3/2006	Petsel et al.	D21/742
D573,673 S *	7/2008	Noyes	D21/736
D591,807 S *	5/2009	Rollinson	D21/744

* cited by examiner

Primary Examiner—Mitchell I Siegel

(74) *Attorney, Agent, or Firm*—Palomar Patent; Mary Jo Redman; Calif Tervo

(57) **CLAIM**

The design for a head for a training putter, as shown and described.

DESCRIPTION

FIG. 1 is a perspective view of a head for a training putter showing my new design; the broken line showing of the fragmented shaft and counterweight is included for the purpose of illustrating and forms no part of the claimed design.

FIG. 2 is a top plan view thereof; the bottom plan view being a mirror image;

FIG. 3 is a front elevation view thereof;

FIG. 4 is a left side view thereof;

FIG. 5 is a right side view thereof; and,

FIG. 6 is a rear elevation view thereof.

1 Claim, 2 Drawing Sheets

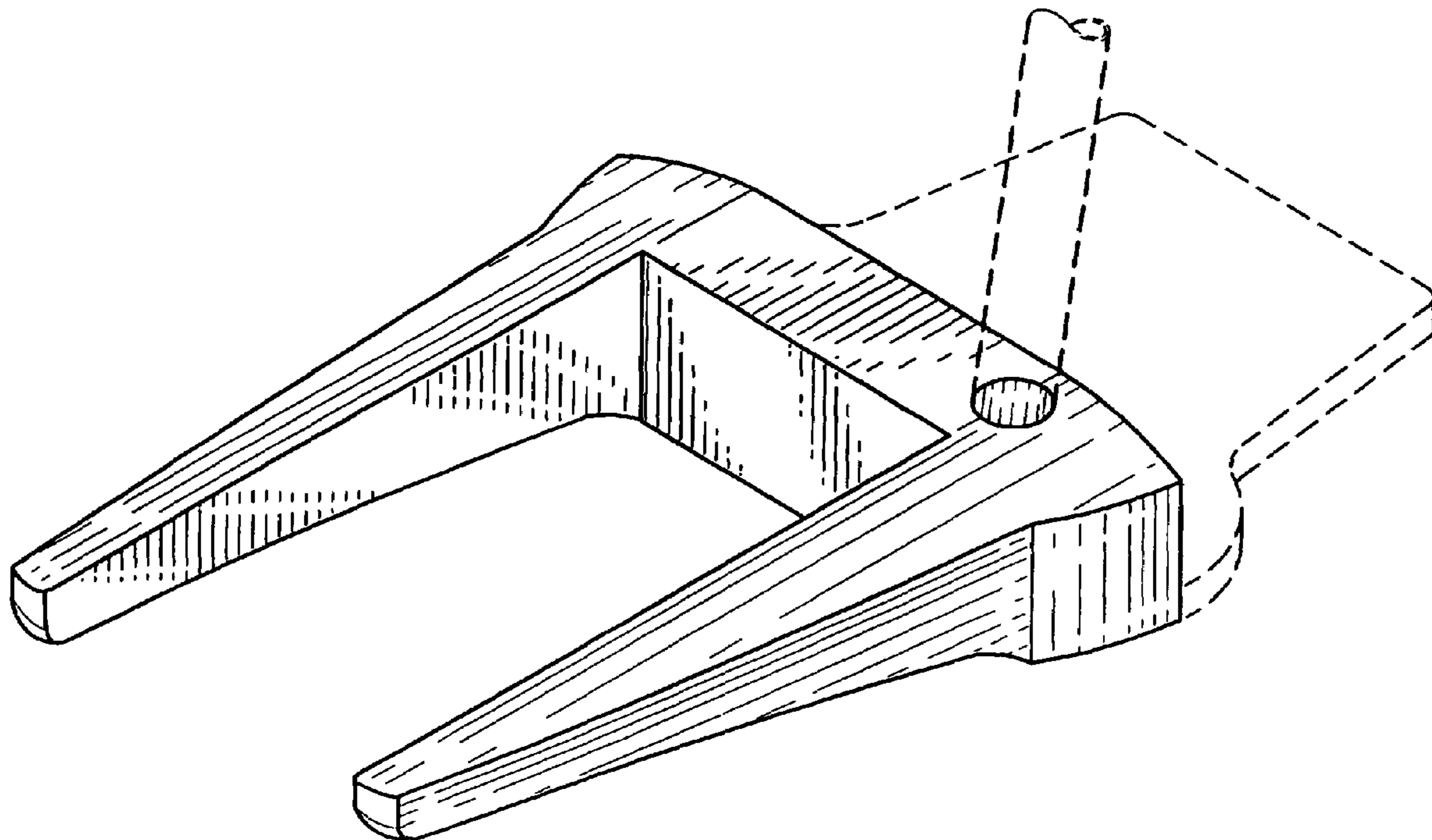

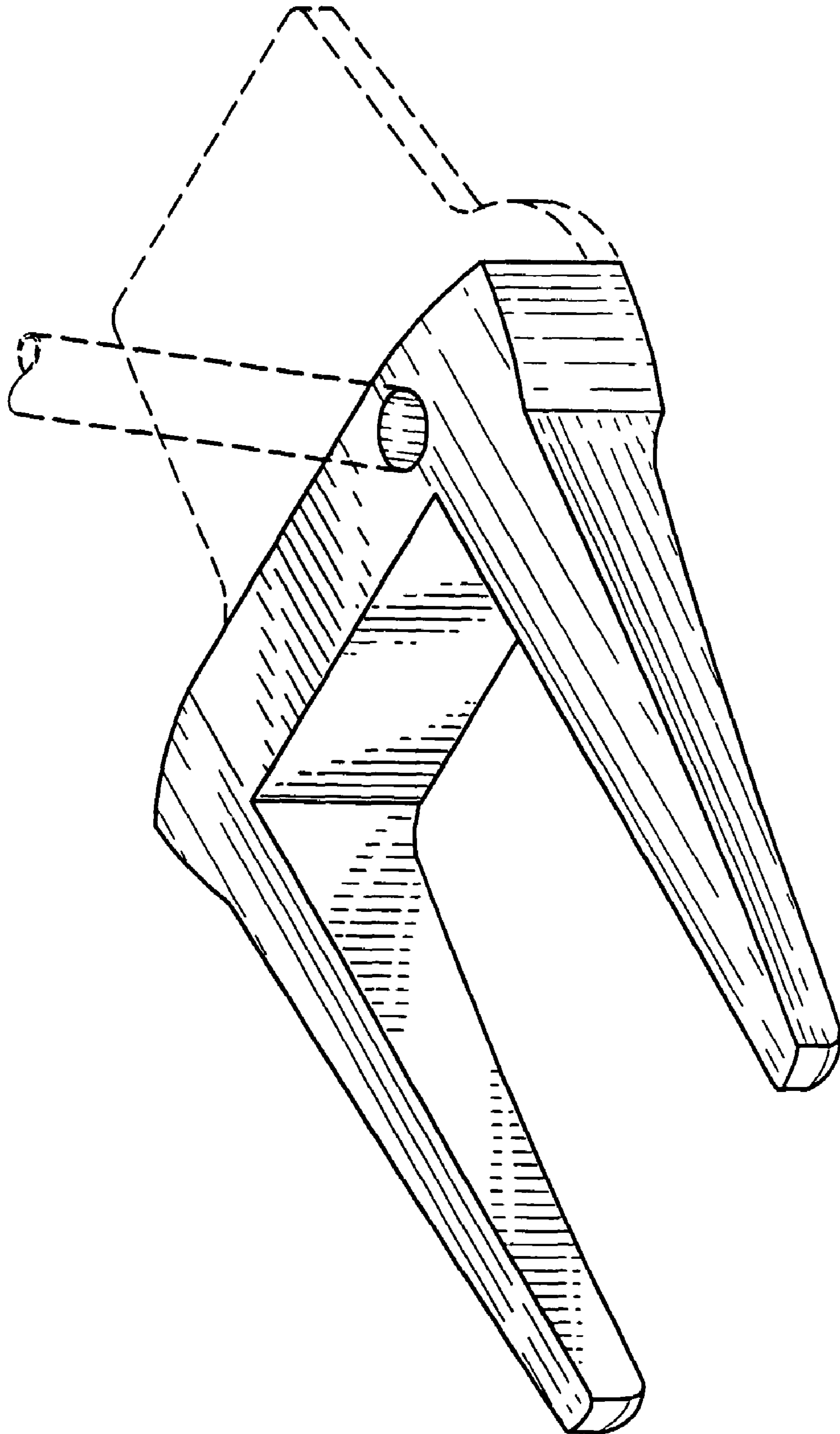

FIG. 1

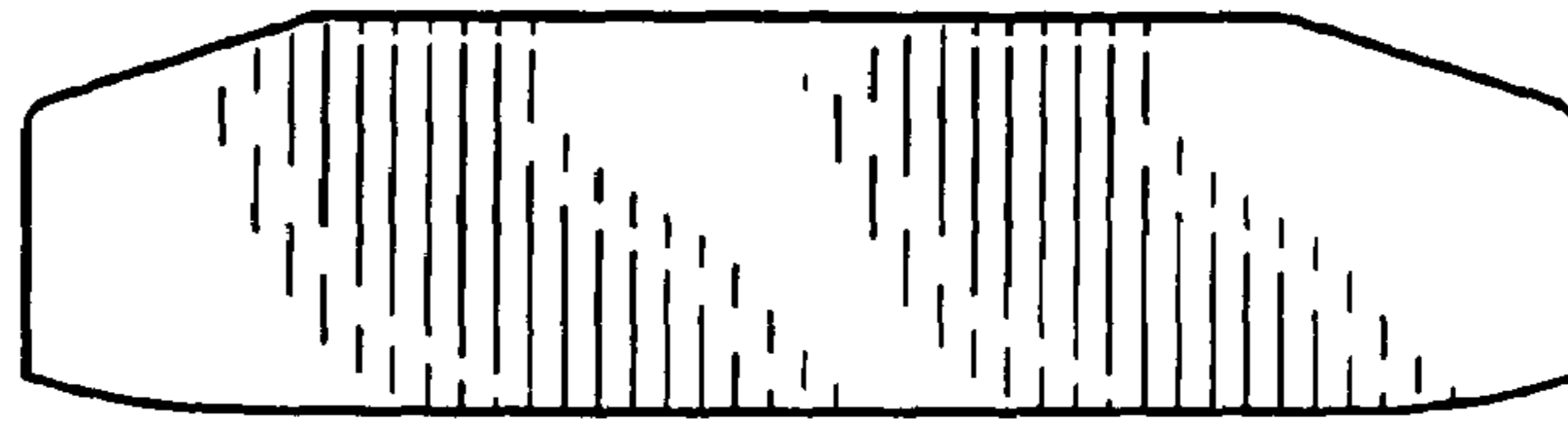

FIG. 6

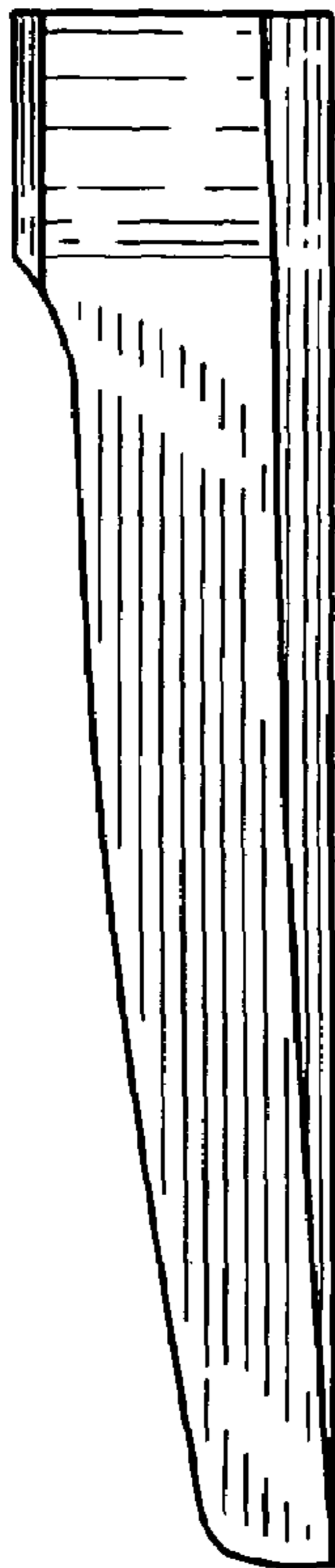

FIG. 4

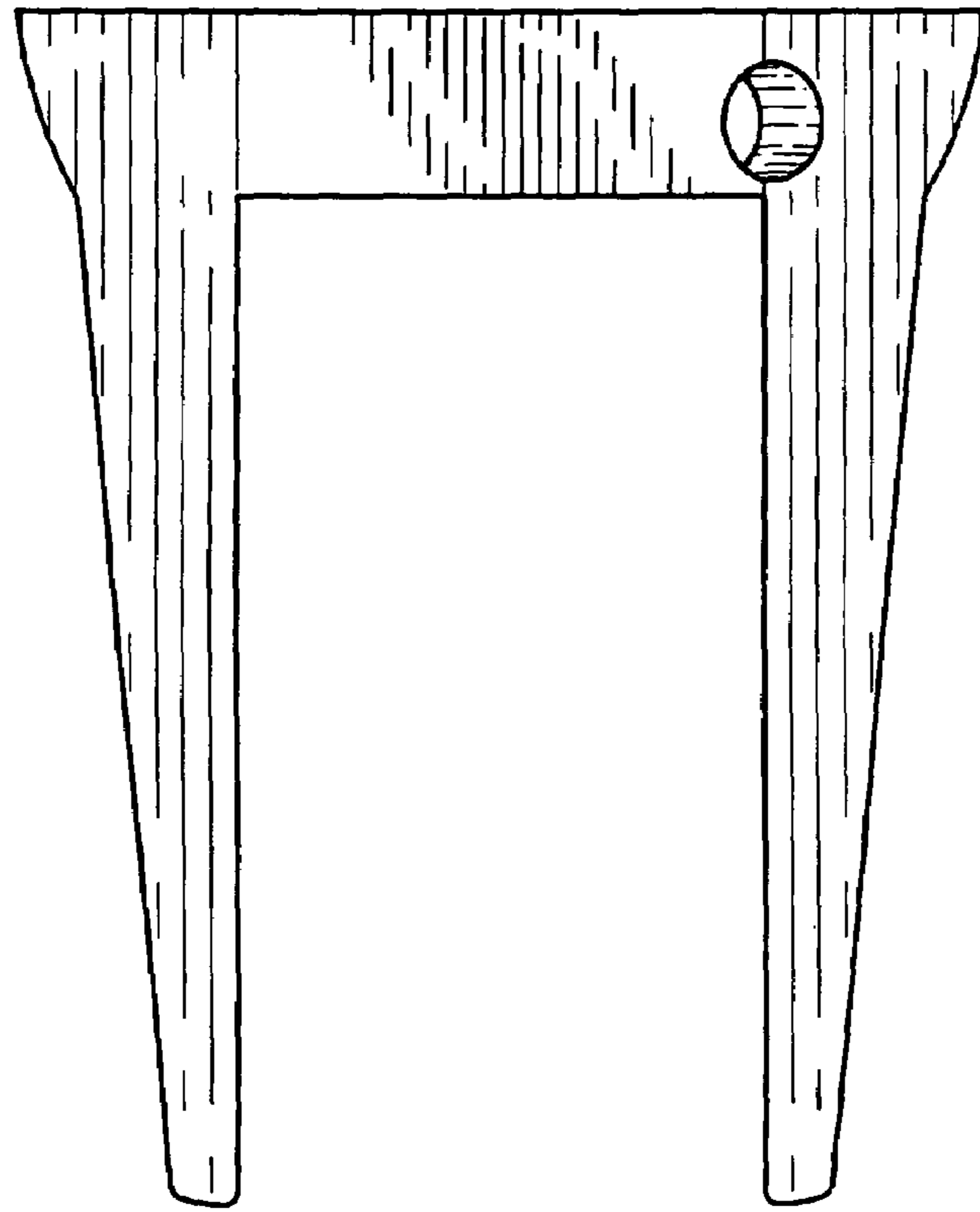

FIG. 2

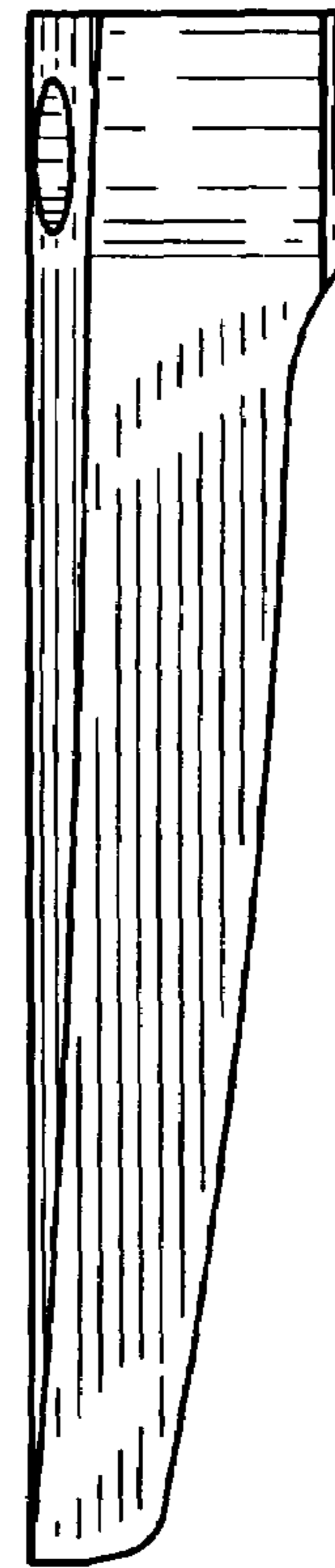

FIG. 5

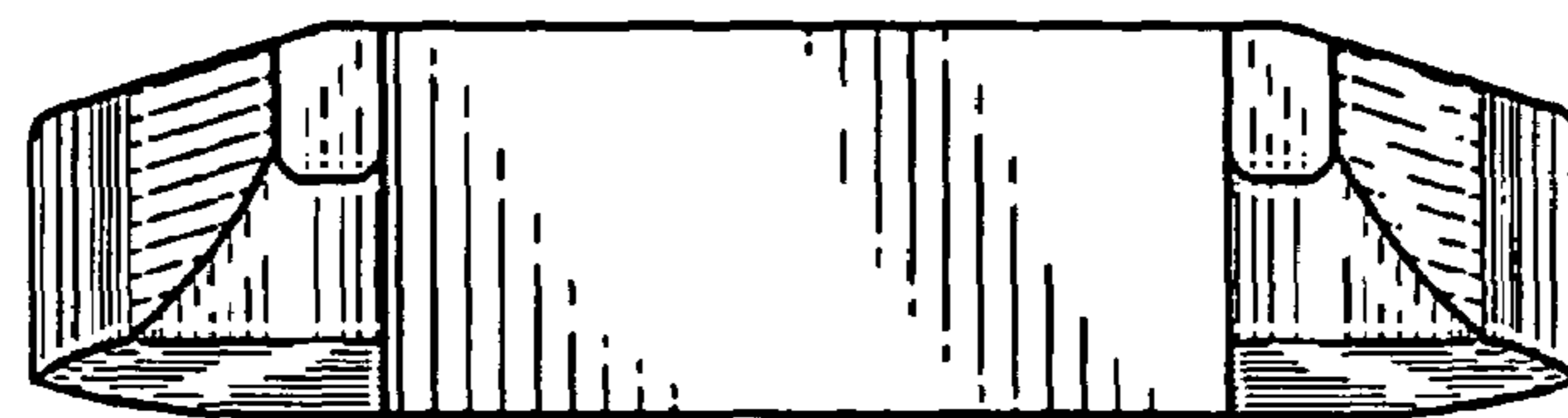

FIG. 3