

US00D604744S

(12) **United States Design Patent**
Tseng et al.

(10) **Patent No.:** **US D604,744 S**

(45) **Date of Patent:** **** Nov. 24, 2009**

(54) **MUSIC PLAYER**

(75) Inventors: **Huai-Te Tseng**, Taipei (TW); **Chia-An Chen**, Taipei (TW); **Shao-Tsu Kung**, Taipei (TW)

(73) Assignee: **Compal Electronics, Inc.**, Taipei (TW)

(**) Term: **14 Years**

(21) Appl. No.: **29/304,060**

(22) Filed: **Feb. 25, 2008**

(51) **LOC (9) Cl.** **14-03**

(52) **U.S. Cl.** **D14/496; D14/497; D14/168**

(58) **Field of Classification Search** D14/496, D14/497, 435, 463, 217, 168, 137, 138, 160; 345/156, 169, 173-179, 903; 455/11.1, 7.73, 455/344-351, 93-95; 370/342-344; 369/1, 369/2, 6, 12; 463/43-47; 273/148 B
See application file for complete search history.

(56) **References Cited**

U.S. PATENT DOCUMENTS

D346,600 S *	5/1994	Grasso	D14/189
D370,221 S *	5/1996	Firlow	D14/135
6,132,281 A *	10/2000	Klitsner et al.	446/75
6,195,932 B1 *	3/2001	Aicher	43/112
D446,218 S *	8/2001	Nosrat et al.	D14/496
7,095,867 B2 *	8/2006	Schul et al.	381/334
7,184,259 B2 *	2/2007	Marler et al.	361/679.23
7,209,648 B2 *	4/2007	Barber et al.	386/117
D568,339 S *	5/2008	Skurdal	D14/496
D582,428 S *	12/2008	Lee	D14/496

7,499,270 B2 * 3/2009 Allen 211/8
2007/0037475 A1 * 2/2007 Spear 446/330

* cited by examiner

Primary Examiner—Prabhakar Deshmukh

(74) *Attorney, Agent, or Firm*—Jianq Chyun IP Office

(57) **CLAIM**

The ornamental design for a music player, as shown and described

DESCRIPTION

FIG. 1 is a front perspective view of a music player showing our new design;

FIG. 2 is a rear perspective view thereof;

FIG. 3 is a front view thereof;

FIG. 4 is a rear view thereof;

FIG. 5 is a left side view thereof;

FIG. 6 is a right side view thereof;

FIG. 7 is a top view thereof;

FIG. 8 is a bottom view thereof;

FIG. 9 is a front perspective reference view thereof with the symbols thereon; and,

FIG. 10 is a left side view of FIG. 9.

The broken lines immediately adjacent to the claimed areas in the views represent the boundaries of the design. The broken lines in the figures illustrate the portions of the design that form no part of the claim. None of the broken lines form any part of the claimed design.

1 Claim, 10 Drawing Sheets

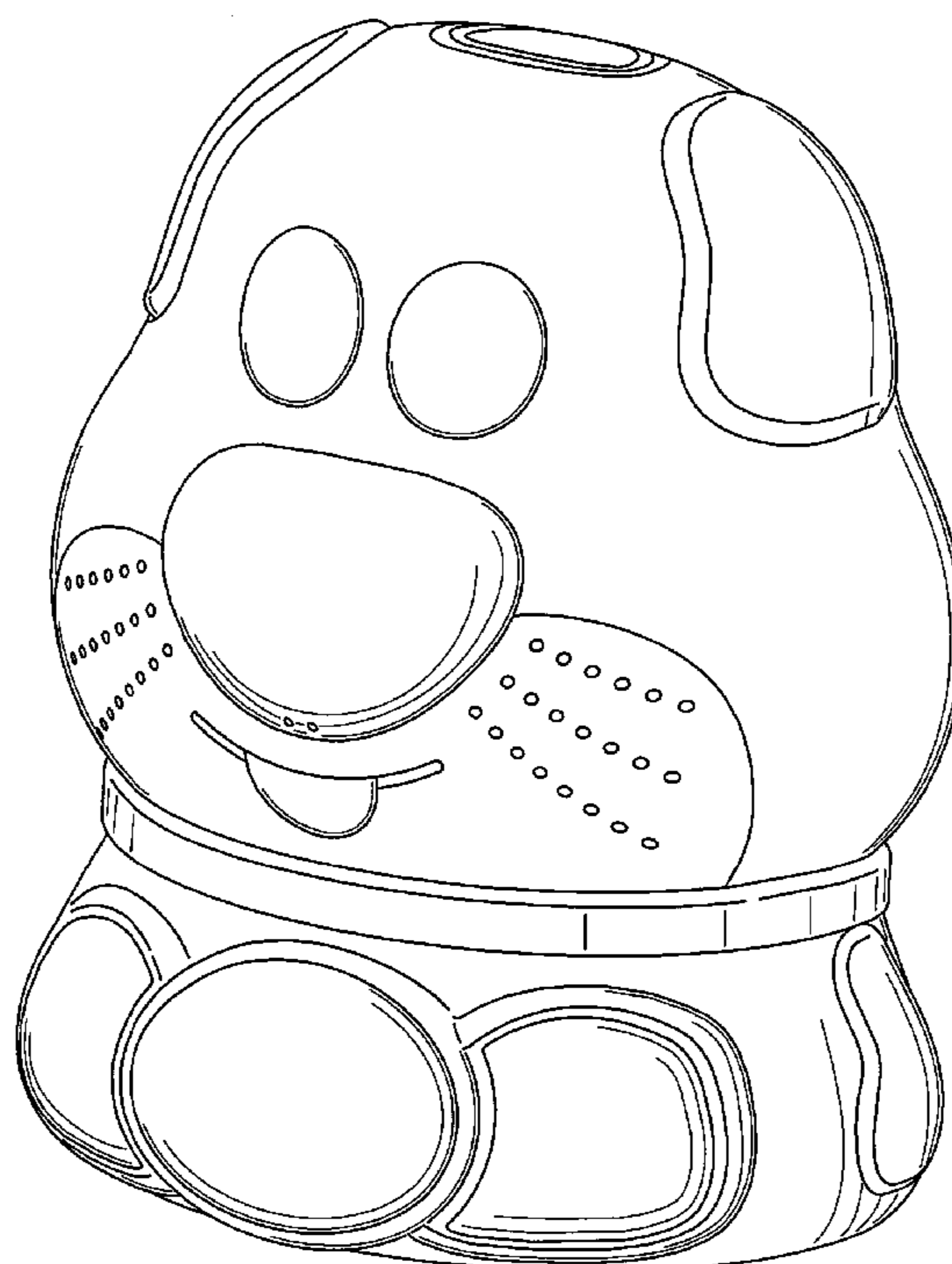

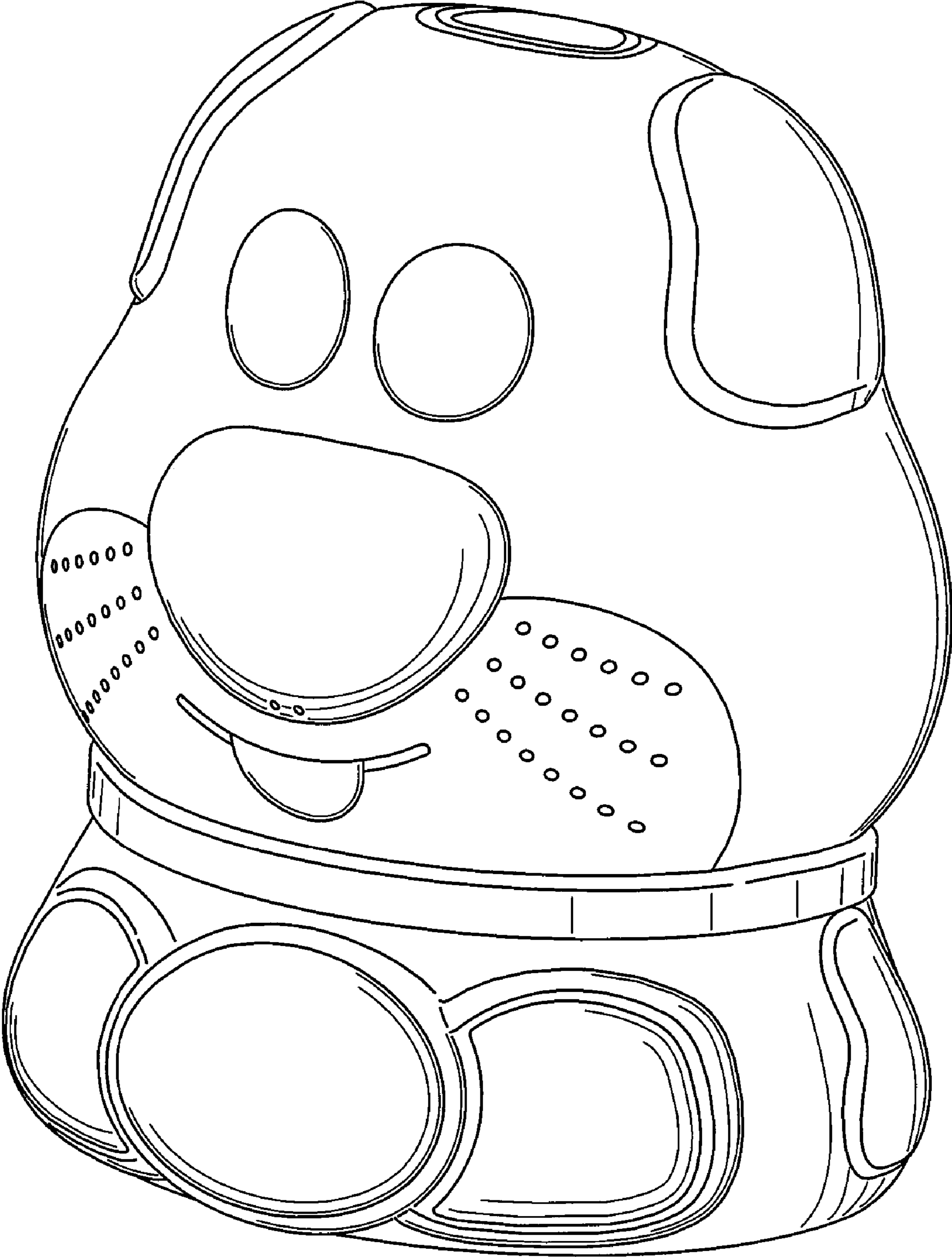

FIG. 1

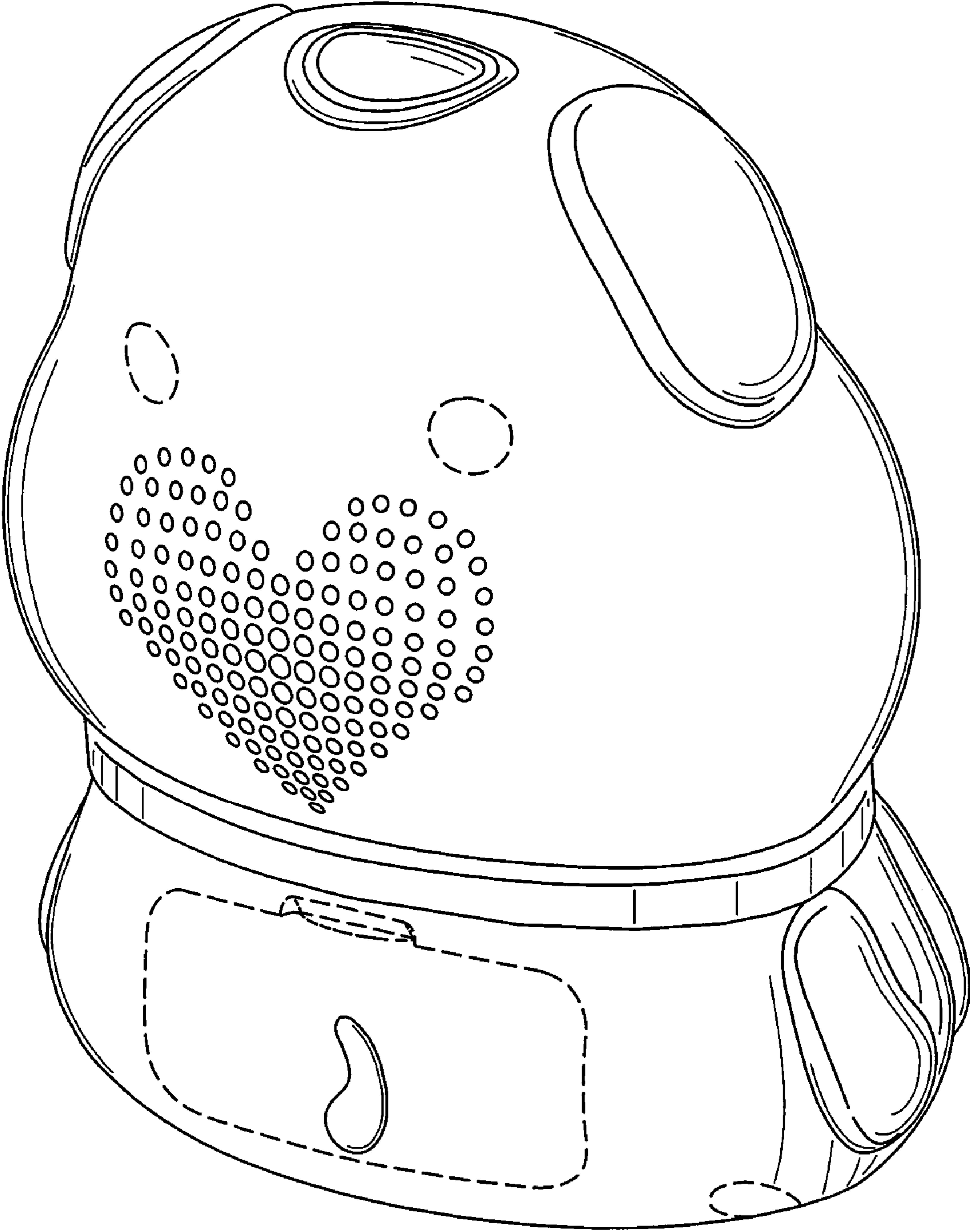

FIG. 2

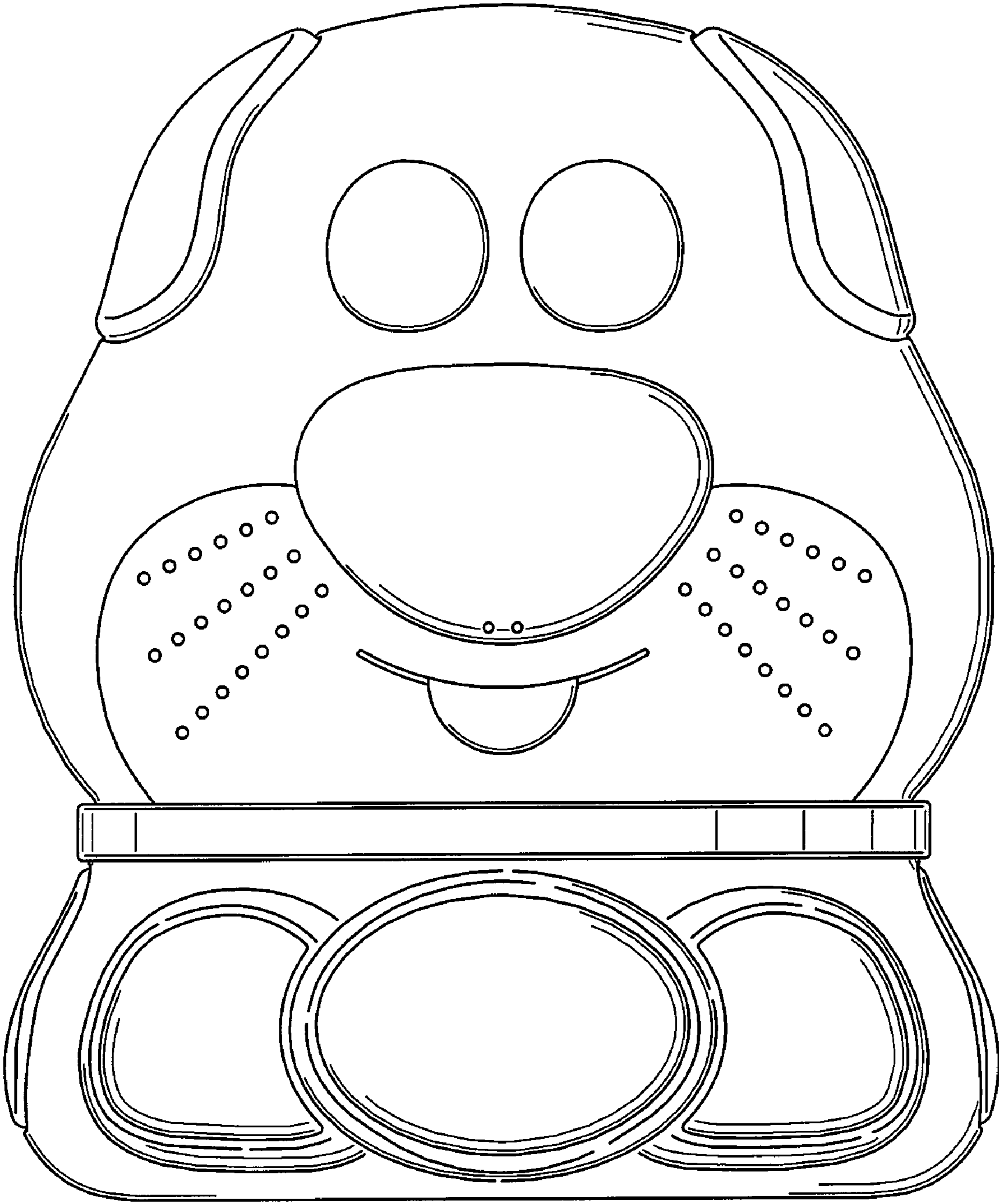

FIG. 3

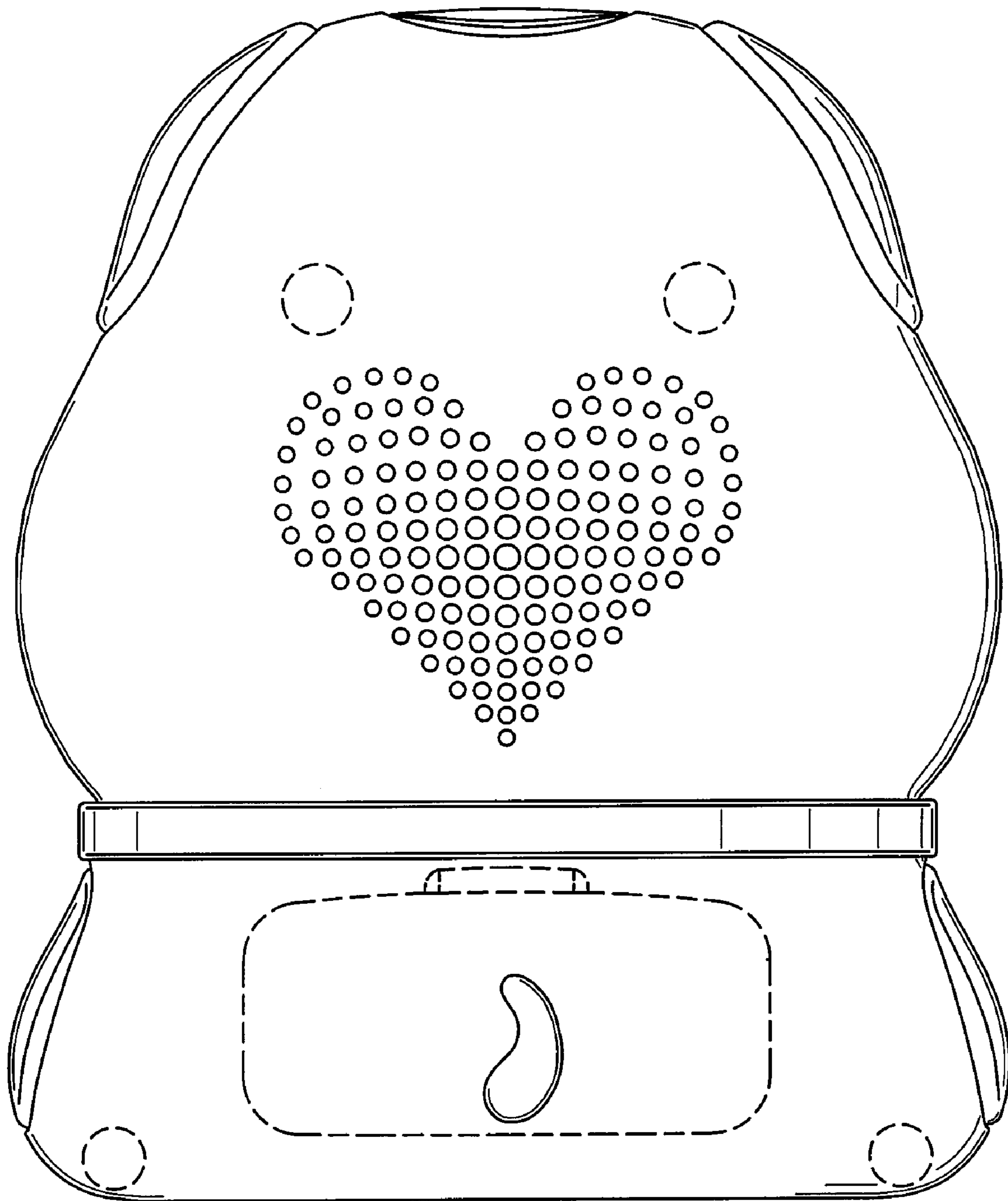

FIG. 4

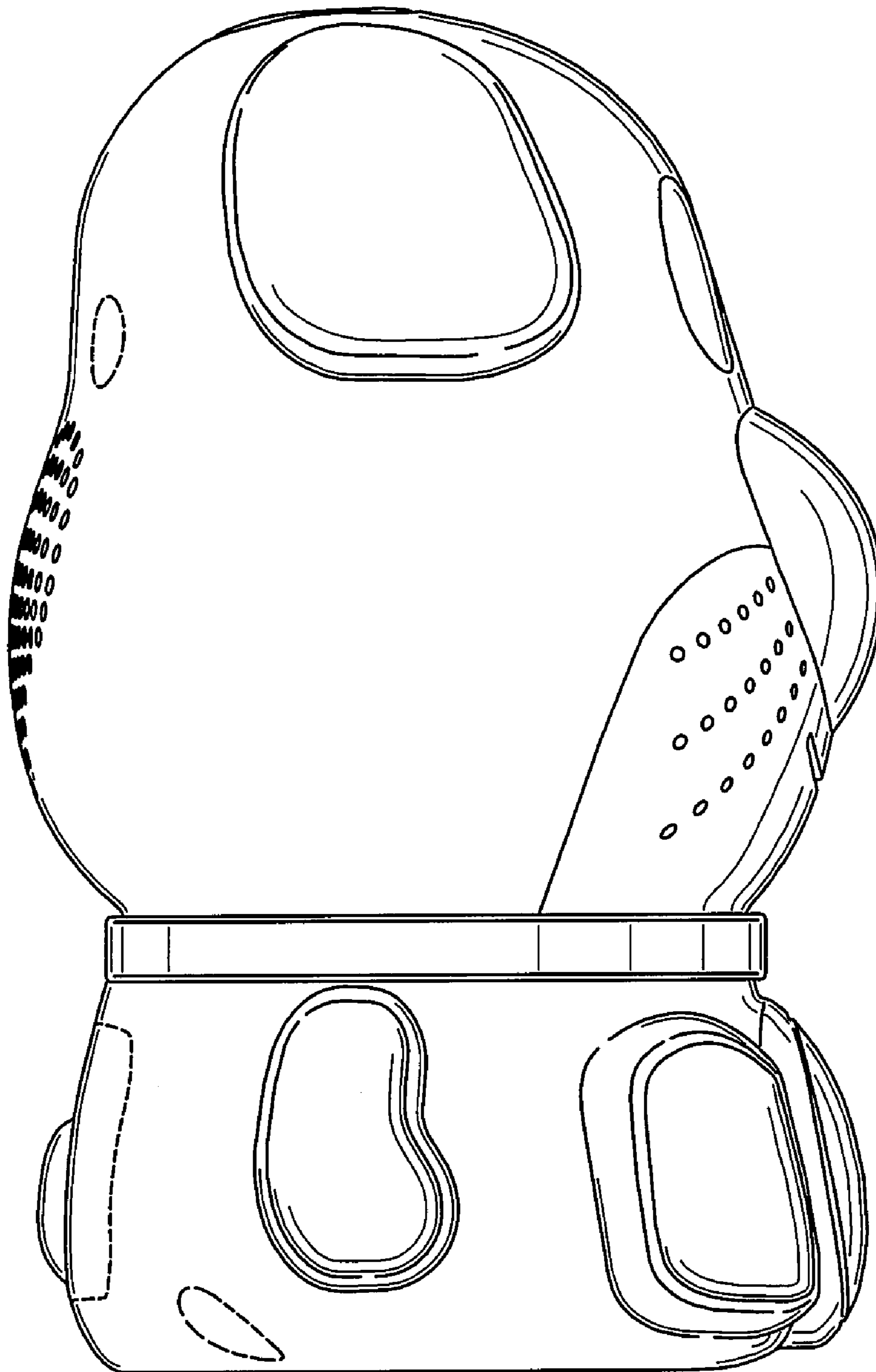

FIG. 5

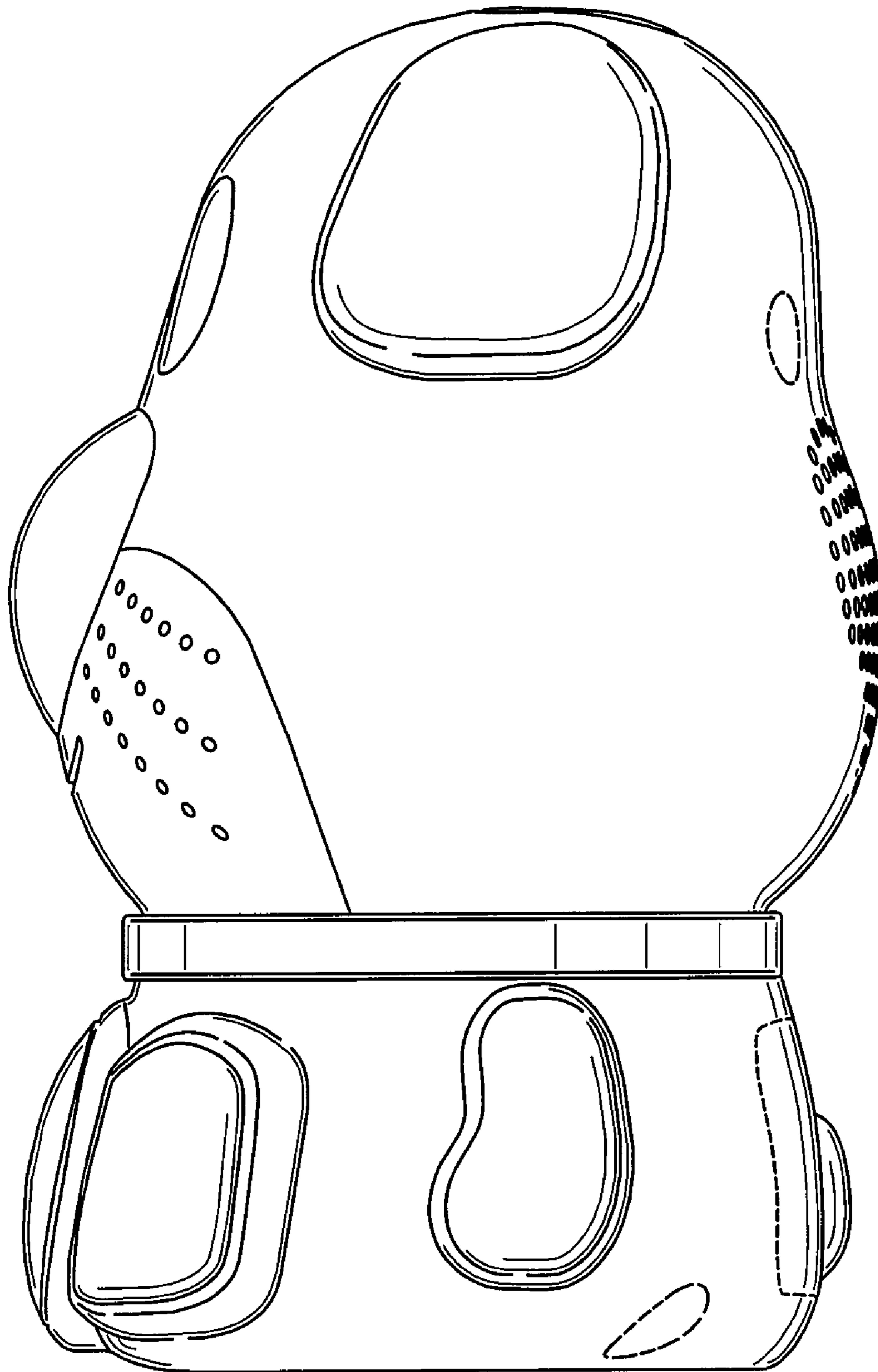

FIG. 6

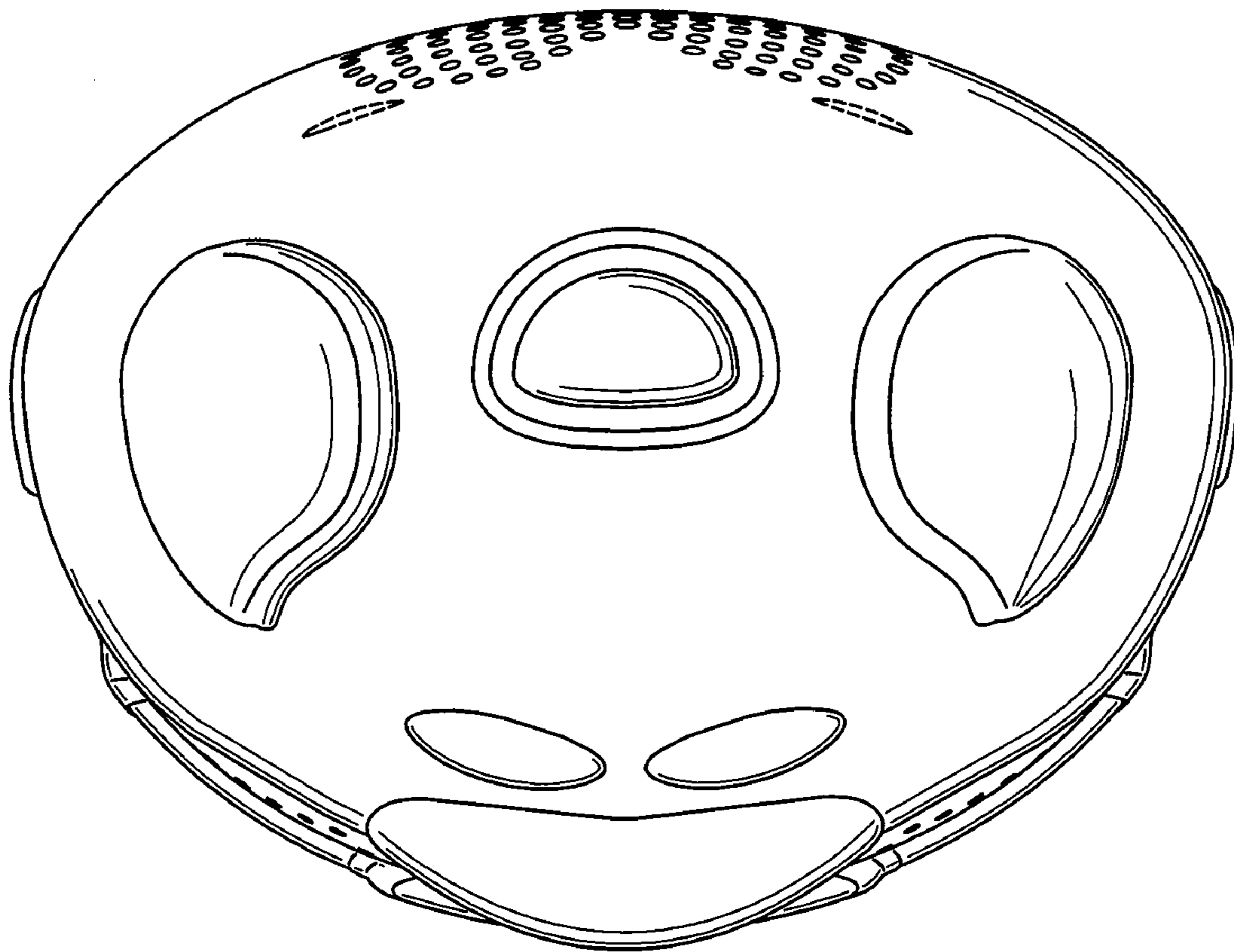

FIG. 7

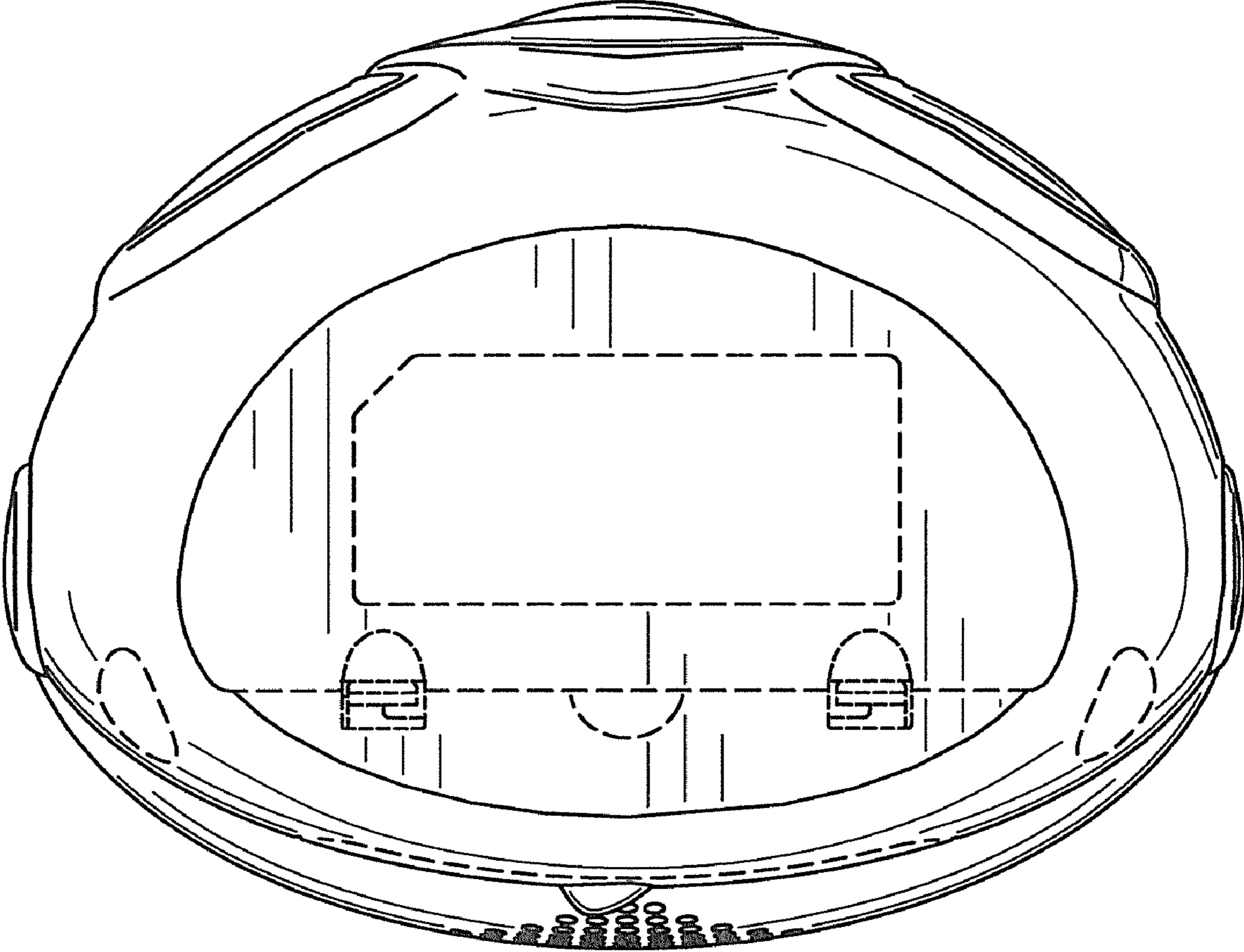

FIG. 8

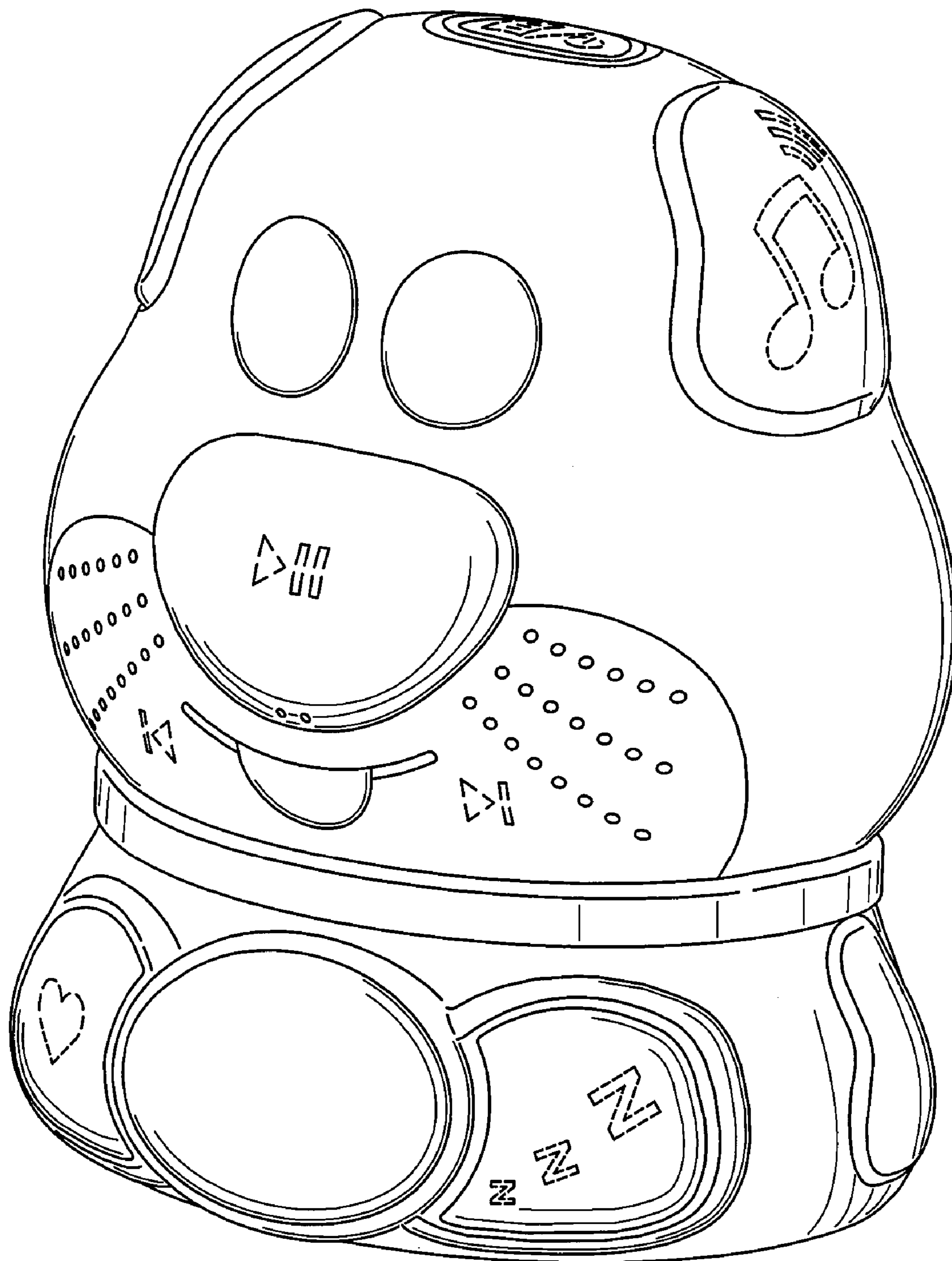

FIG. 9

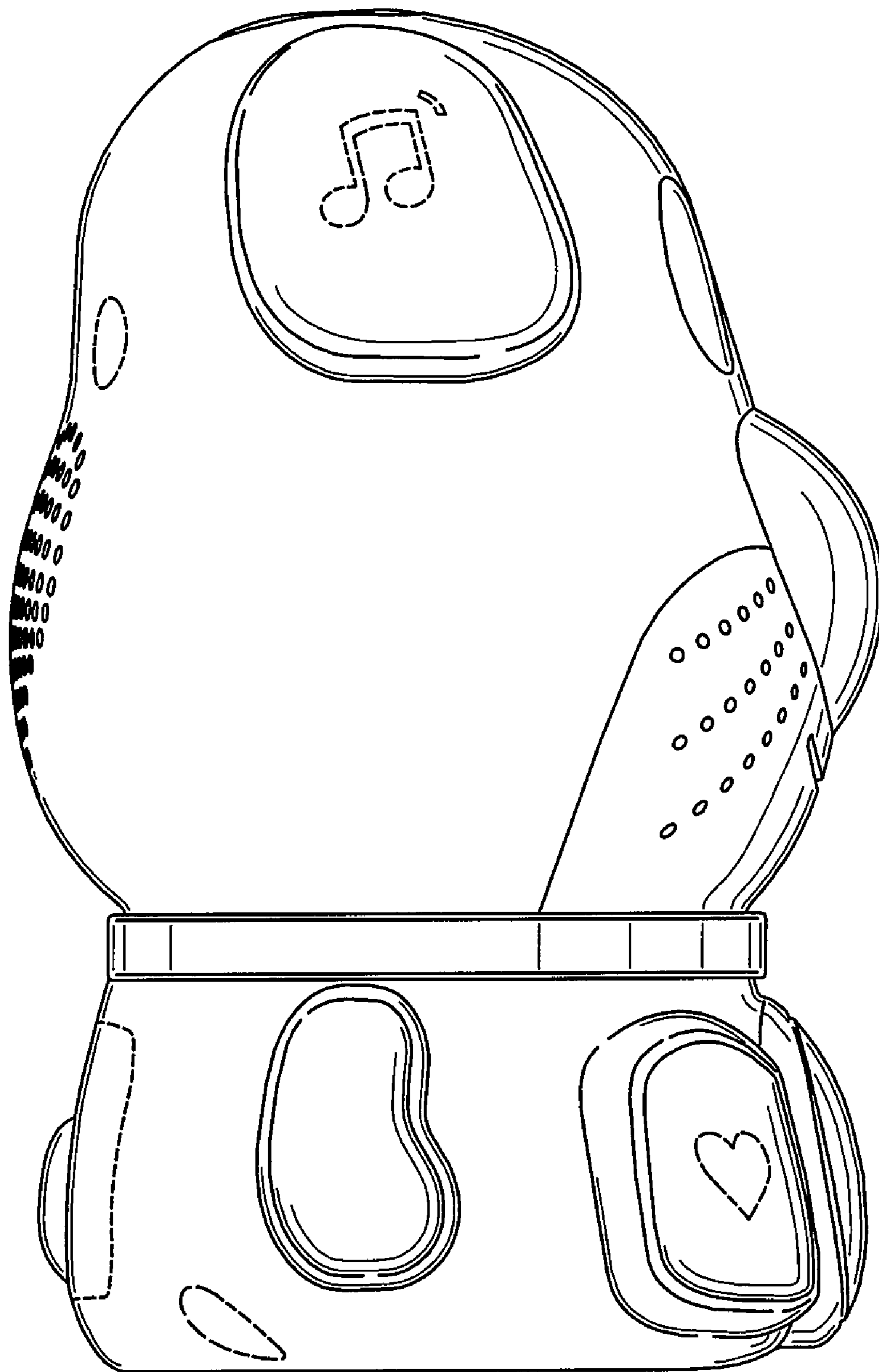

FIG. 10