



US00D604730S

(12) **United States Design Patent**
Shih et al.

(10) **Patent No.:** **US D604,730 S**
(45) **Date of Patent:** **** Nov. 24, 2009**

(54) **MOBILE PERSONAL COMPUTER**

(75) Inventors: **Po-Yang Shih**, Taipei (TW); **Yueh-Han Wu**, Taipei (TW)

(73) Assignee: **Compal Electronics, Inc.**, Taipei (TW)

(**) Term: **14 Years**

(21) Appl. No.: **29/330,846**

(22) Filed: **Jan. 15, 2009**

(30) **Foreign Application Priority Data**

Oct. 1, 2008 (TW) 97305693

(51) **LOC (9) Cl.** **14-02**

(52) **U.S. Cl.** **D14/346; D14/345**

(58) **Field of Classification Search** D14/341-347,
D14/137, 138, 138 AA, 138 R, 138 AB, 138 AC,
D14/138 AD, 138 C, 138 G, 496, 203.1,
D14/203.3, 203.4, 203.5, 203.6, 203.7, 426,
D14/427, 428, 429, 129, 130; D21/333,
D21/324, 329, 330; D18/7; D10/65; 455/556.1,
455/556.2, 566, 575.1, 575.3, 575.4, 90.3;
D19/60; 379/433.04, 433.07, 433.11, 433.12,
379/433.13, 910, 916; 345/169, 901, 905
See application file for complete search history.

(56) **References Cited**

U.S. PATENT DOCUMENTS

- D312,821 S * 12/1990 Kemp D14/340
- D321,347 S * 11/1991 Colida D14/138 AB
- D321,349 S * 11/1991 Colida D14/138 AB
- D344,494 S * 2/1994 Cardenas D14/344
- D435,526 S * 12/2000 Huang et al. D14/130
- D435,550 S * 12/2000 Chu et al. D14/345
- D503,402 S * 3/2005 Su et al. D14/388
- 7,333,321 B2 * 2/2008 Sutton et al. 361/679.09
- D580,433 S * 11/2008 Chiang et al. D14/345

- D584,304 S * 1/2009 Lin D14/346
- D592,175 S * 5/2009 Rak et al. D14/138 AB
- 2008/0310088 A1 * 12/2008 Chen 361/680

* cited by examiner

Primary Examiner—Jennifer Rivard

Assistant Examiner—Angela J Lee

(74) *Attorney, Agent, or Firm*—Jiang Chyun IP Office

(57) **CLAIM**

The ornamental design for a mobile personal computer, as shown and described.

DESCRIPTION

FIG. 1 is a perspective view of a mobile personal computer showing our new design with the keyboard in an in use position;

FIG. 2 is a front view thereof;

FIG. 3 is a rear view thereof;

FIG. 4 is a left side view thereof;

FIG. 5 is a right side view thereof;

FIG. 6 is a top view thereof; and

FIG. 7 is a bottom view thereof.

FIG. 8 is a perspective view thereof but with the keyboard in the back position;

FIG. 9 is a front view thereof;

FIG. 10 is a rear view thereof;

FIG. 11 is a left side view thereof;

FIG. 12 is a right side view thereof;

FIG. 13 is a top view thereof; and,

FIG. 14 is a bottom view thereof.

The broken lines shown in the drawings are for illustrative purposes only and do not form part of the claimed design.

1 Claim, 10 Drawing Sheets

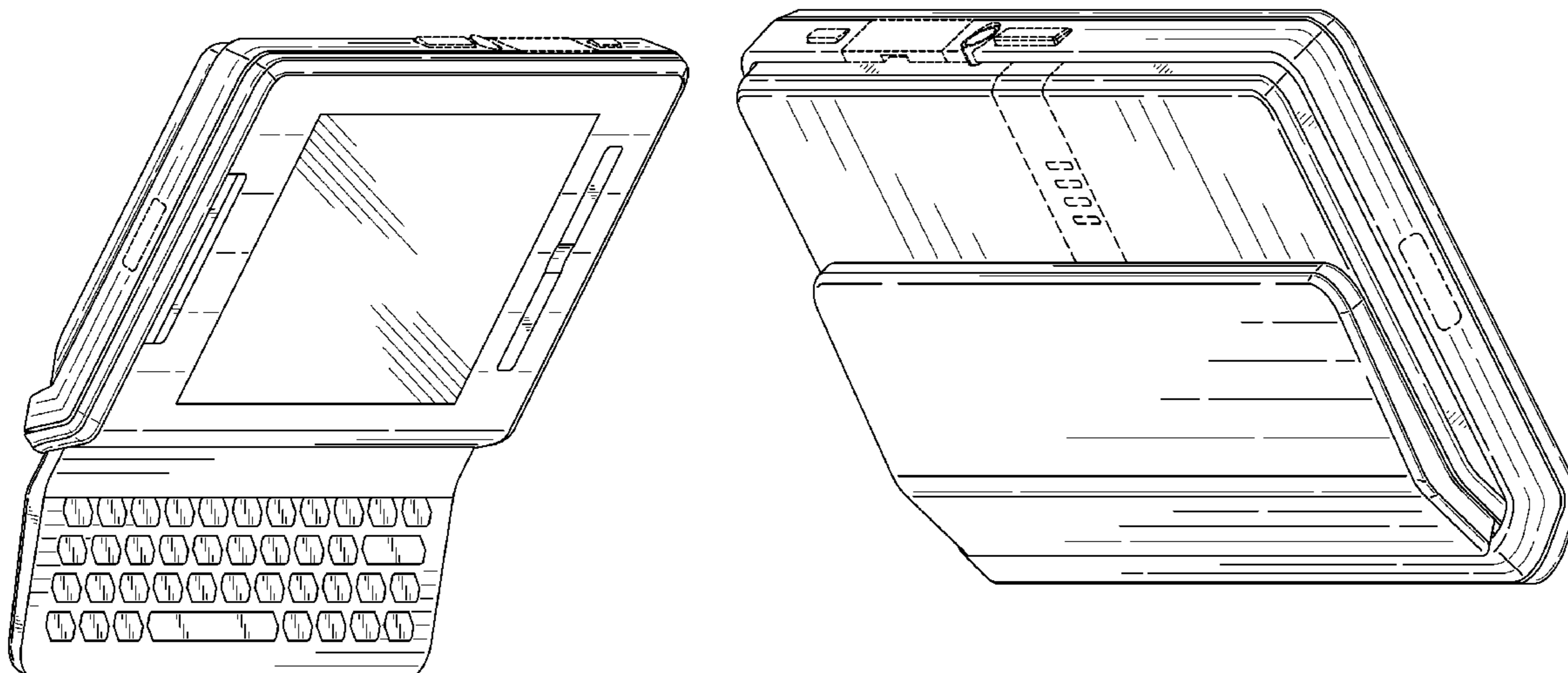

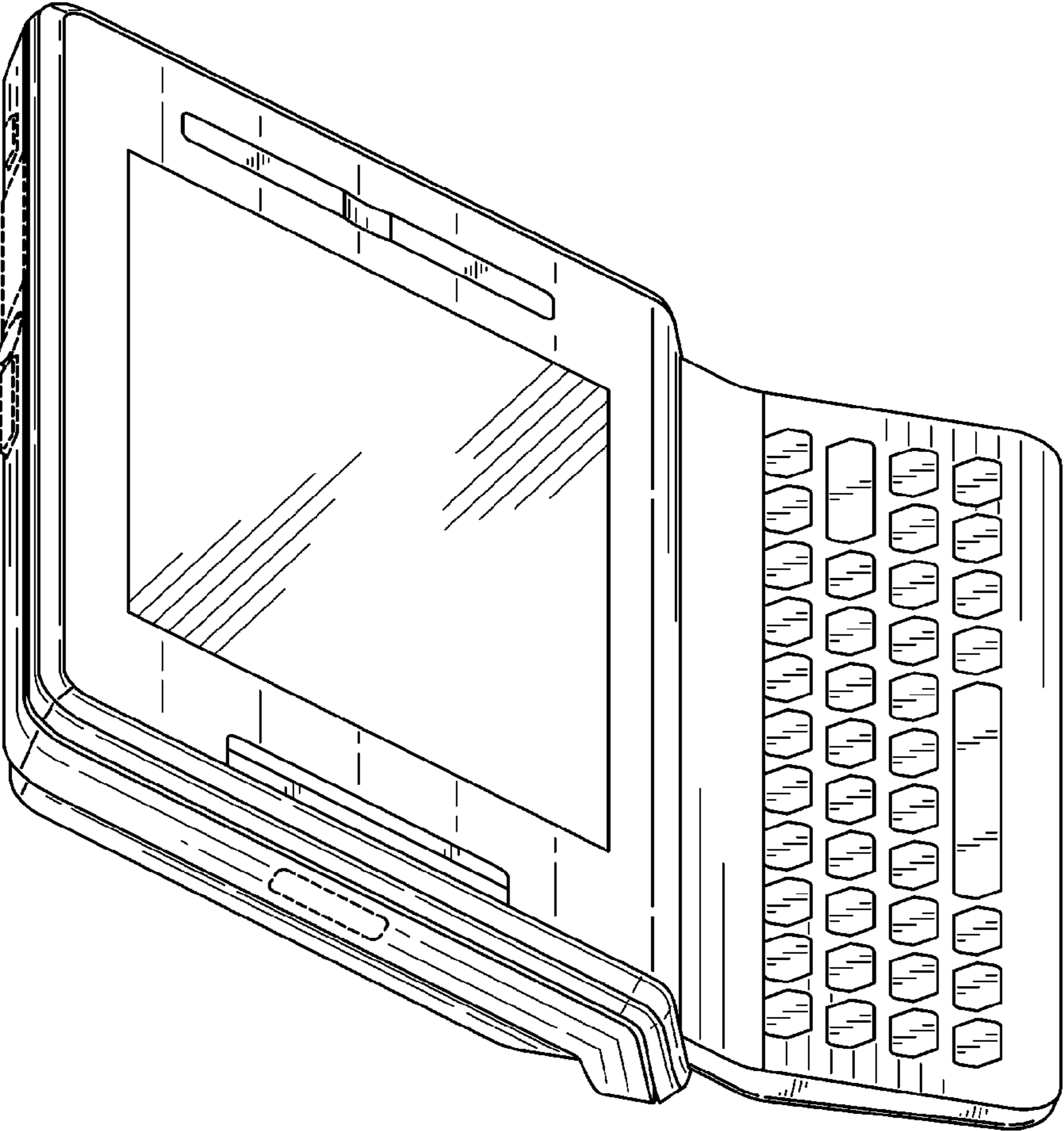

FIG. 1

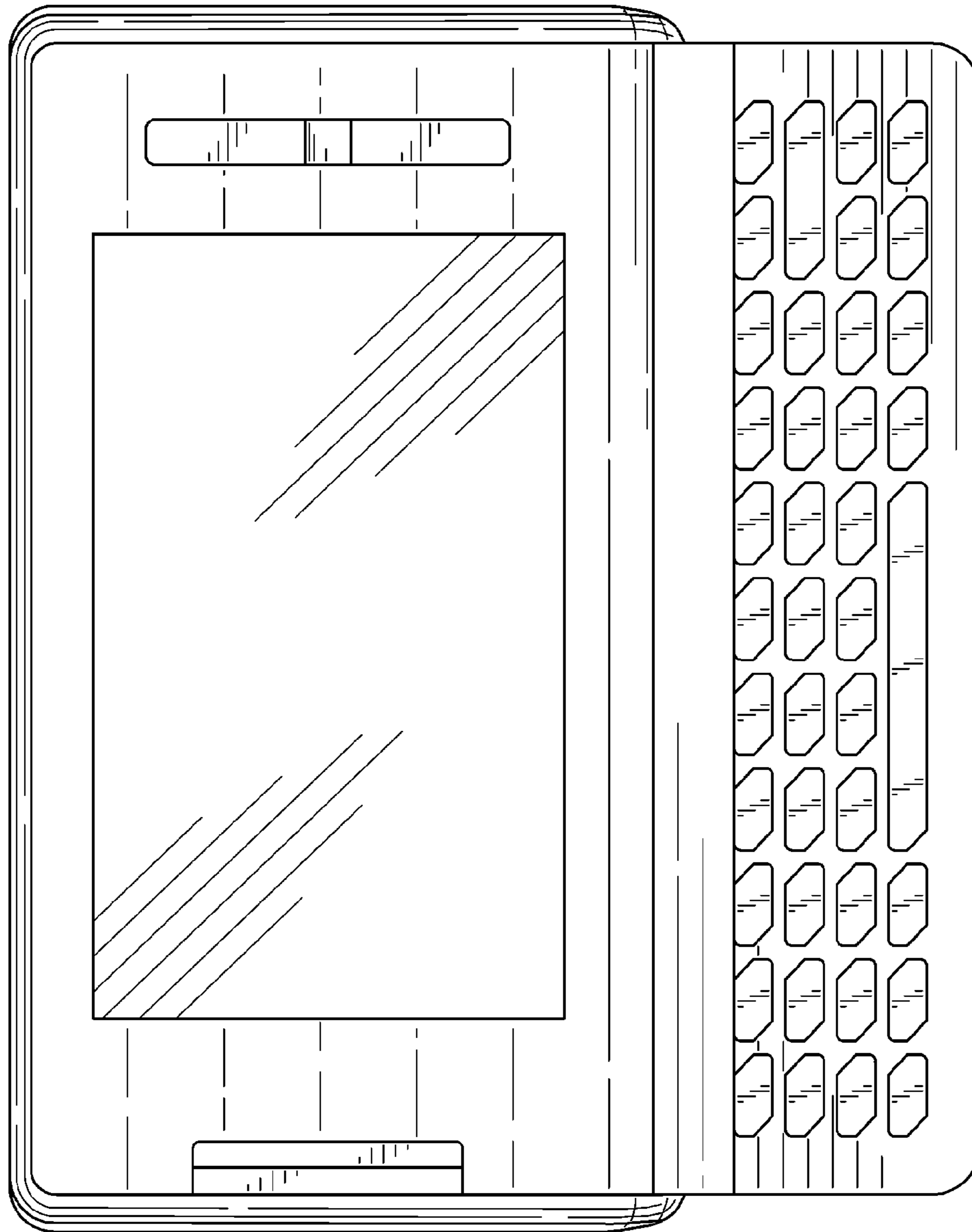

FIG. 2

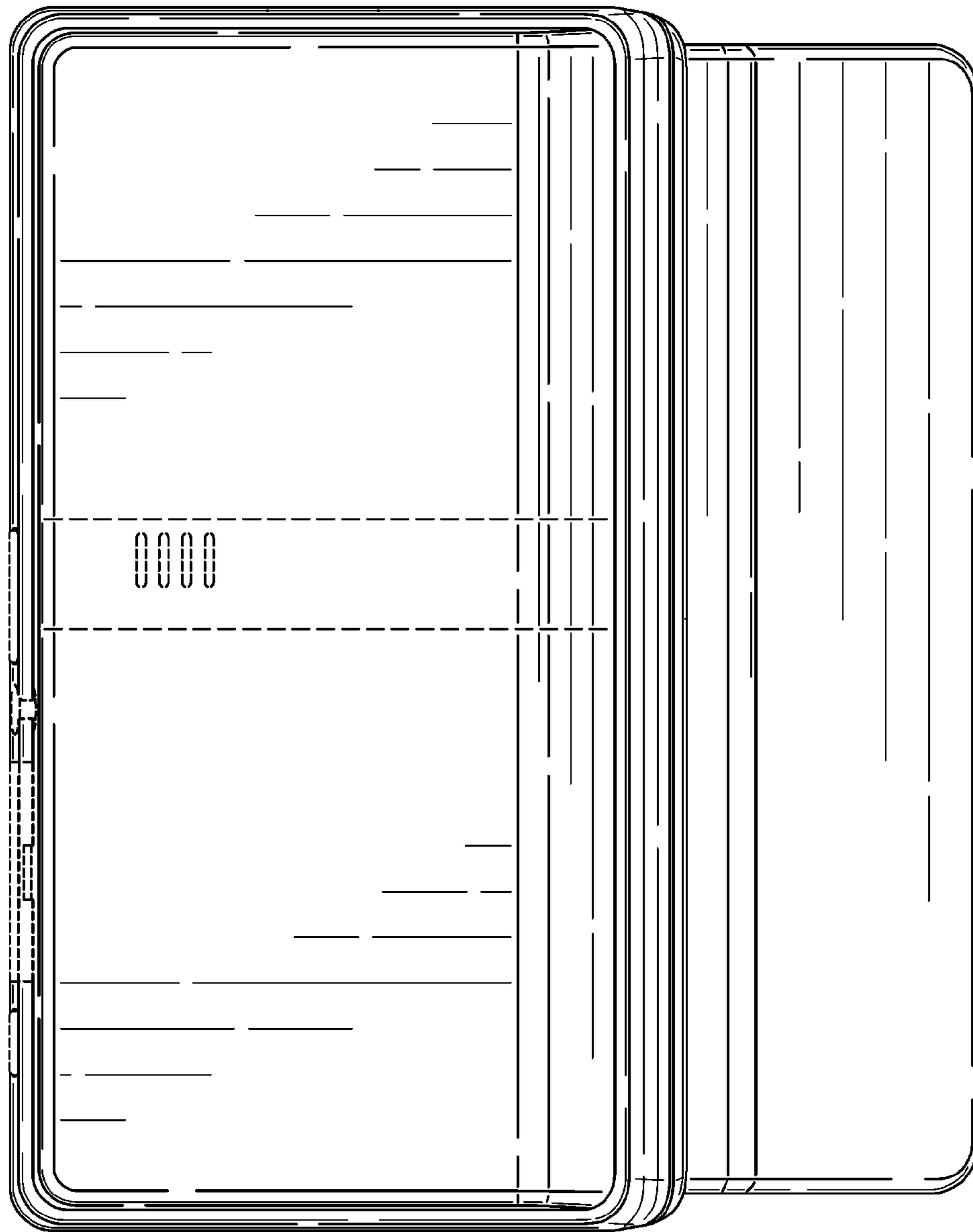

FIG. 3

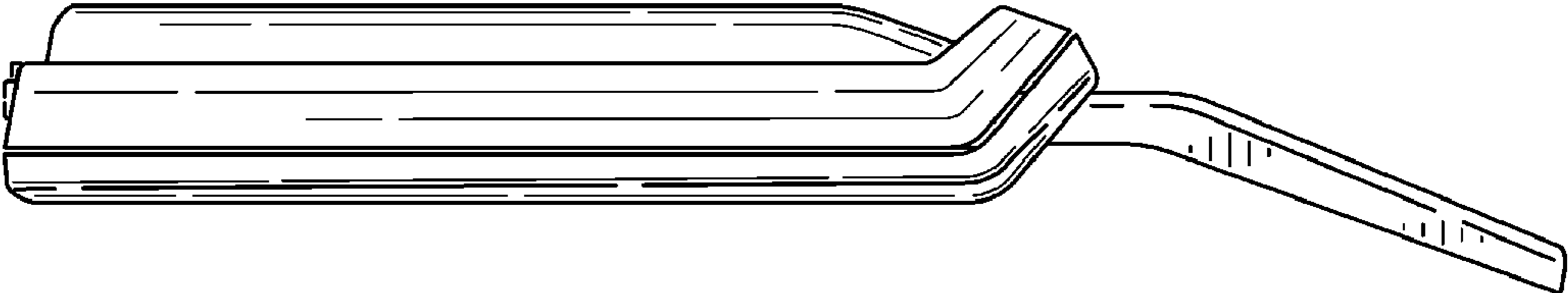

FIG. 5



FIG. 4

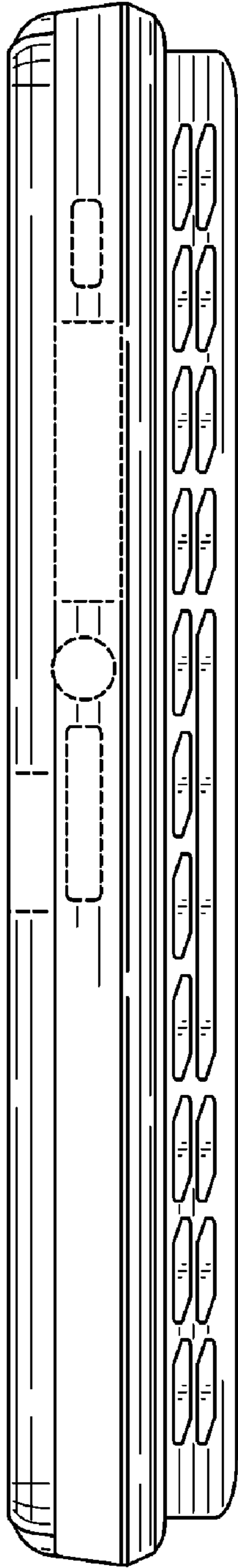

FIG. 6

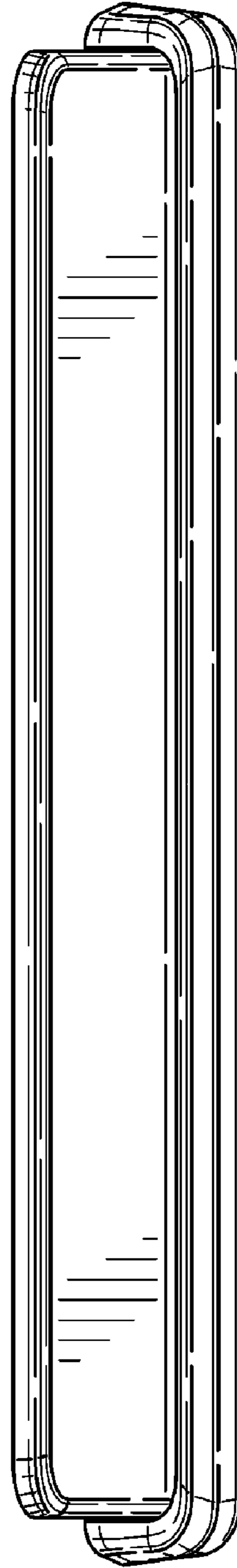

FIG. 7

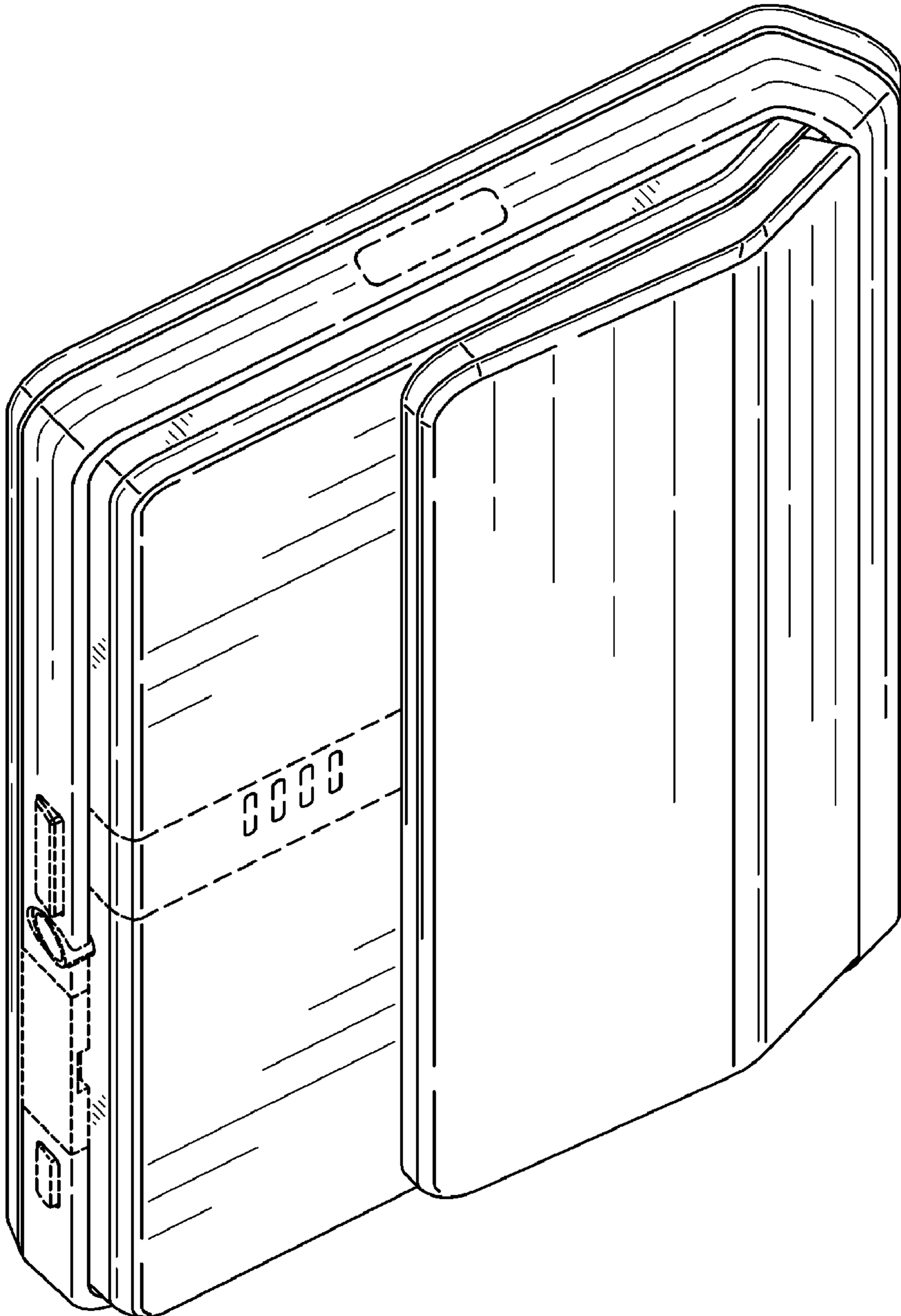

FIG. 8

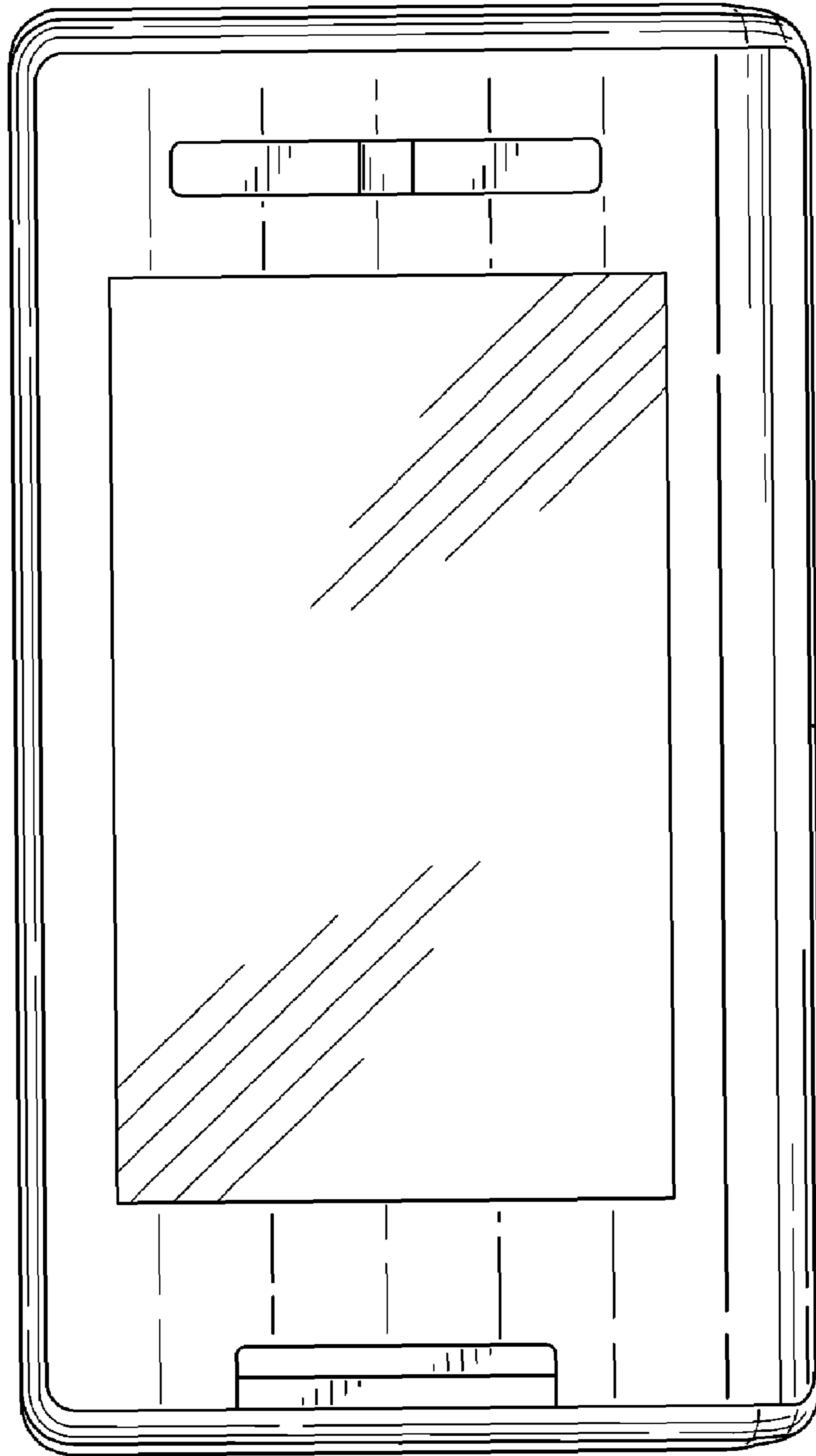

FIG. 9

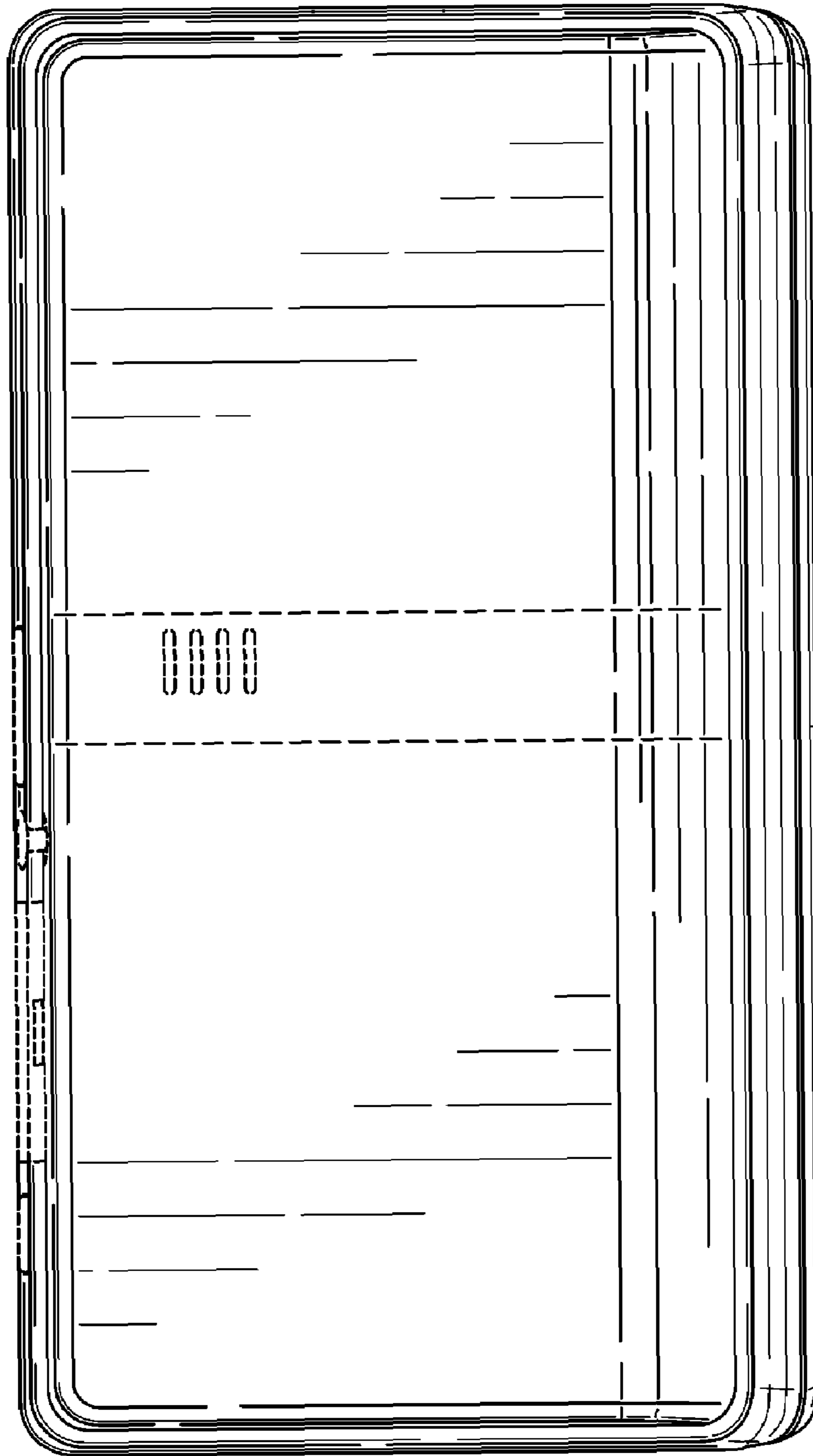

FIG. 10

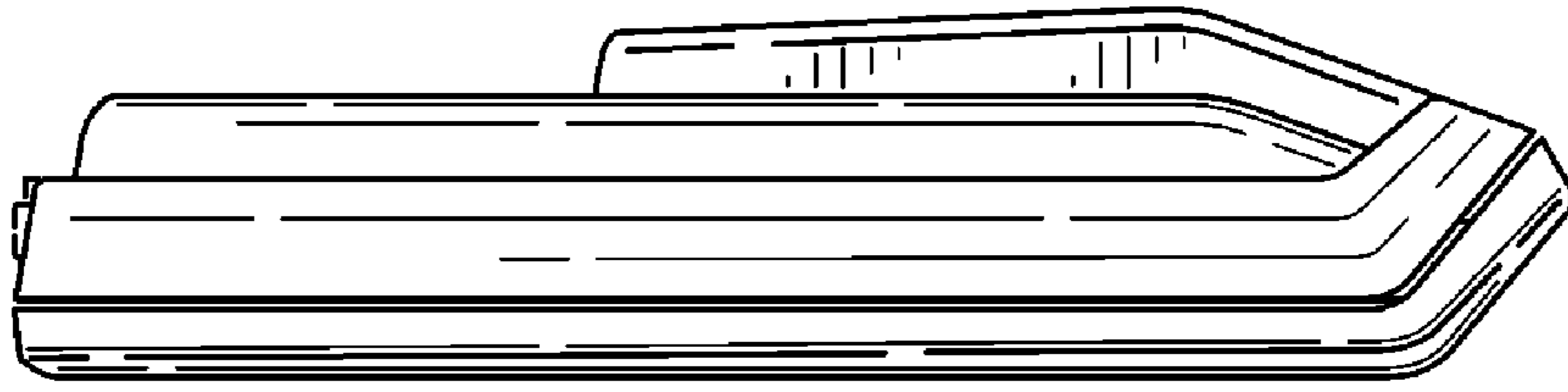

FIG. 12

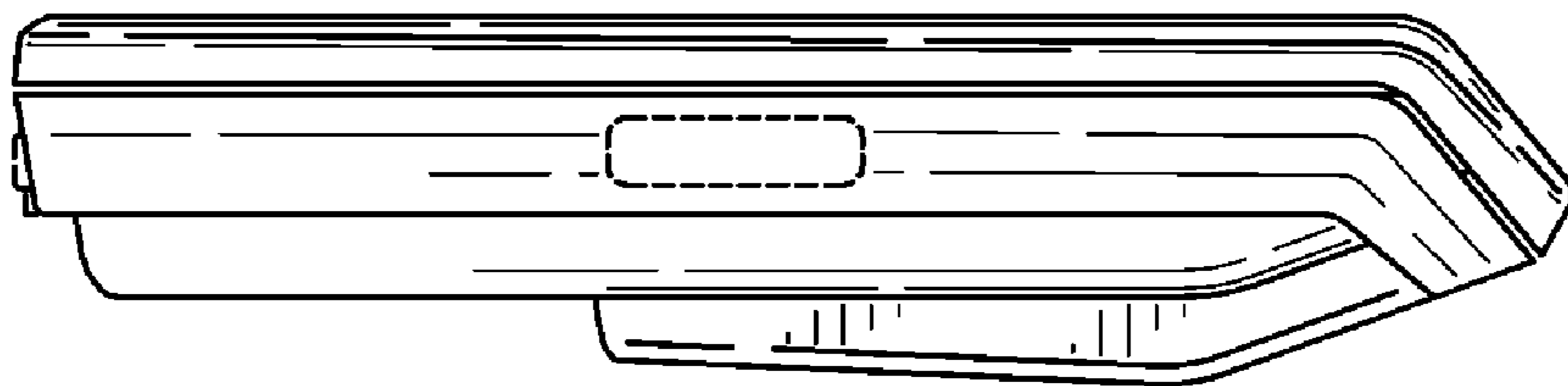

FIG. 11

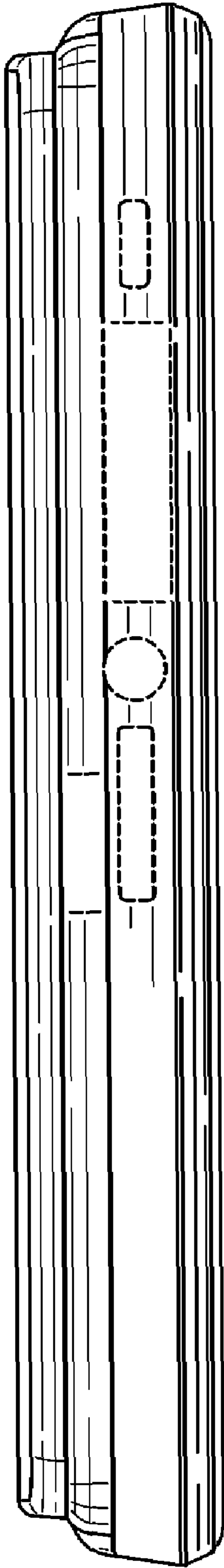

FIG. 13

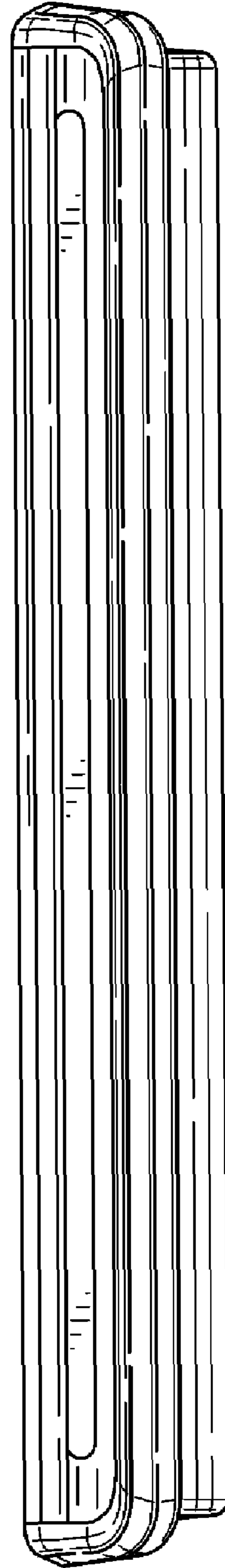

FIG. 14