



US00D604633S

(12) **United States Design Patent**  
**Stearns**

(10) **Patent No.:** **US D604,633 S**

(45) **Date of Patent:** **\*\* Nov. 24, 2009**

(54) **BOTTLE**

D564,361 S 3/2008 Stearns

(76) Inventor: **Brian R. Stearns**, 12465 Julian Ct.,  
Broomfield, CO (US) 80020

\* cited by examiner

*Primary Examiner*—Sandra Morris  
(74) *Attorney, Agent, or Firm*—Dale J. Ream

(\*\*) Term: **14 Years**

(21) Appl. No.: **29/325,441**

(57) **CLAIM**

(22) Filed: **Oct. 1, 2008**

The ornamental design for a bottle, as shown and described.

(51) **LOC (9) Cl.** ..... **09-01**

**DESCRIPTION**

(52) **U.S. Cl.** ..... **D9/674; D9/500**

(58) **Field of Classification Search** ..... D9/600,  
D9/651, 674, 500–504, 516, 552, 565, 572–575;  
206/457–458, 527; 215/379–383, 400; 220/890  
See application file for complete search history.

FIG. 1 is a perspective view of a bottle showing my new design;

FIG. 2 is a front view thereof;

FIG. 3 is a back view thereof;

FIG. 4 is a right side view thereof;

FIG. 5 is a left side view thereof;

FIG. 6 is a top view thereof; and,

FIG. 7 is a bottom view thereof.

(56) **References Cited**

U.S. PATENT DOCUMENTS

D188,566 S *	8/1960	Morian	.....	D9/674
D379,925 S *	6/1997	Ma	.....	D9/674
D407,633 S *	4/1999	Jacobs	.....	D9/674
D537,730 S *	3/2007	Shimizu et al.	.....	D9/674

**1 Claim, 6 Drawing Sheets**

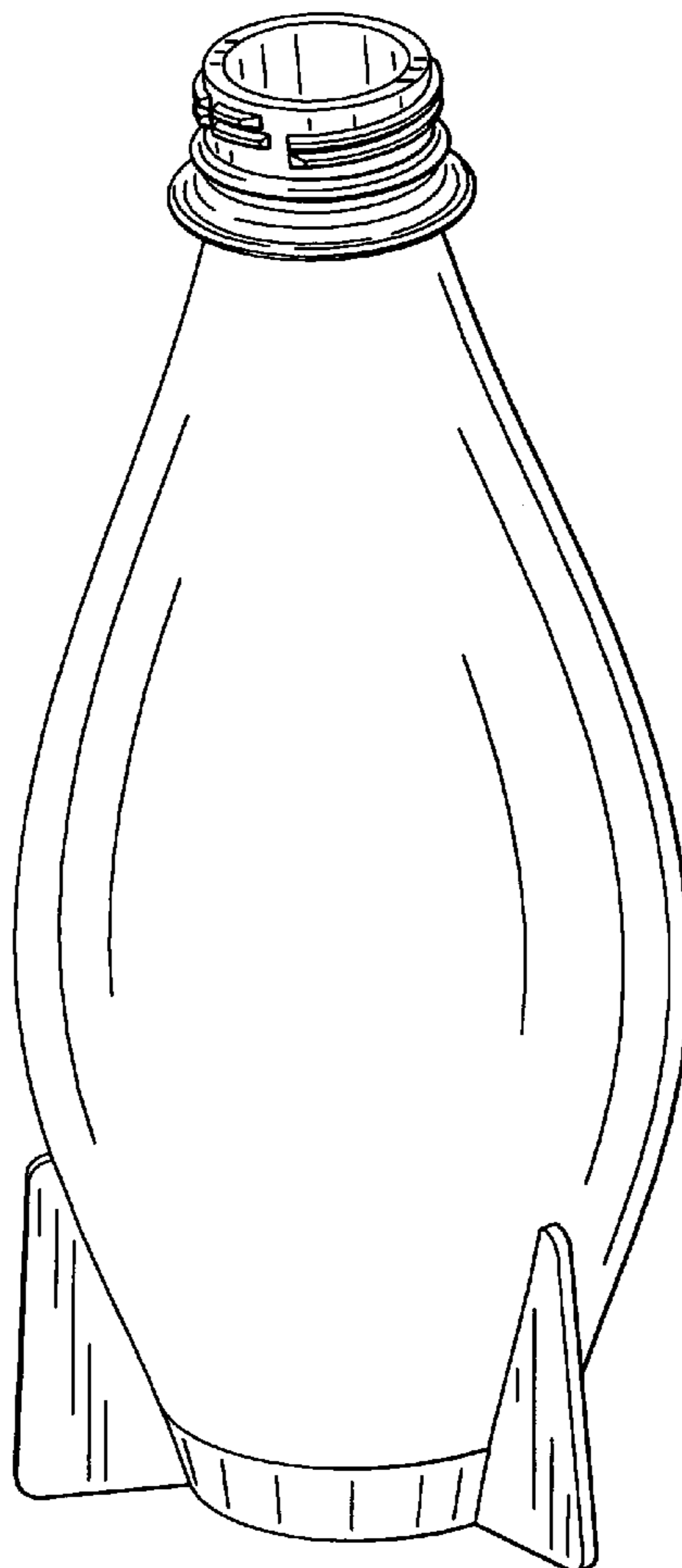

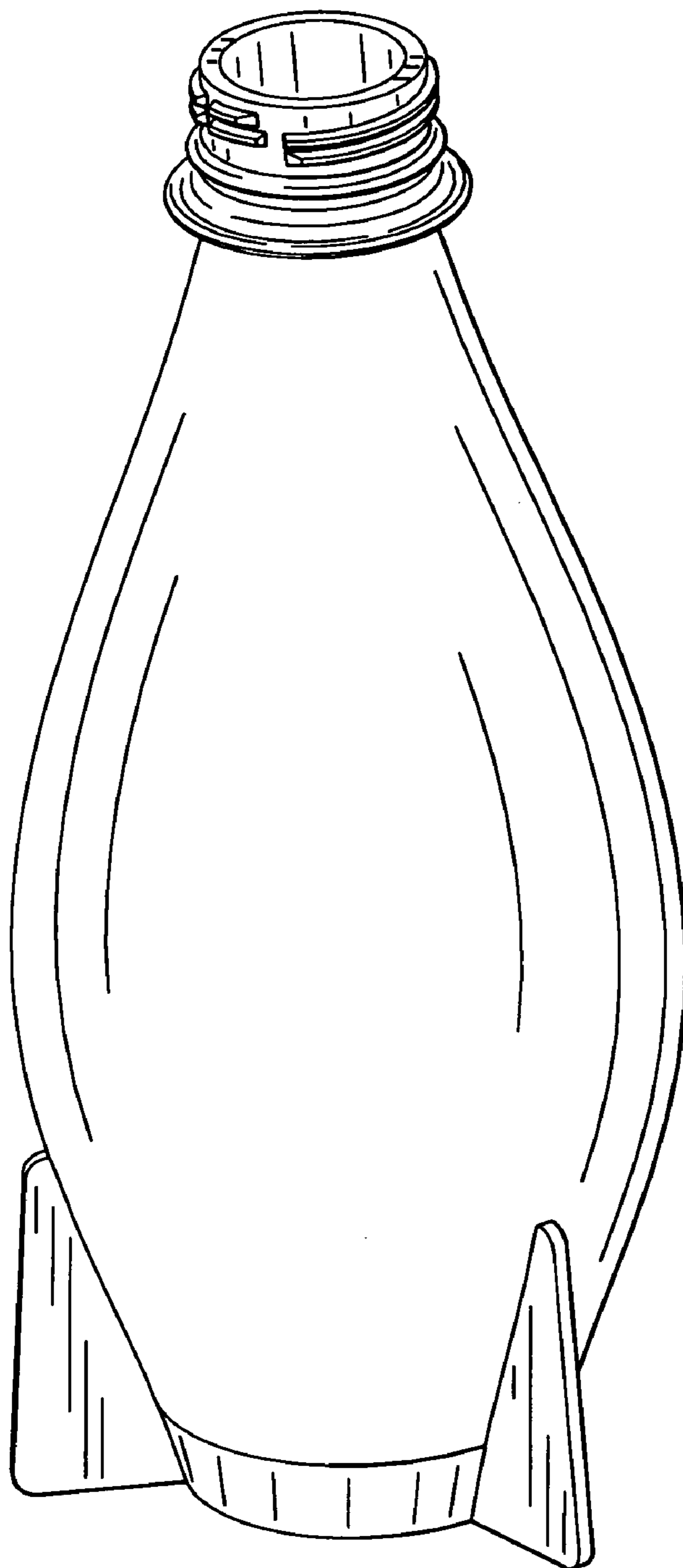

FIG. 1

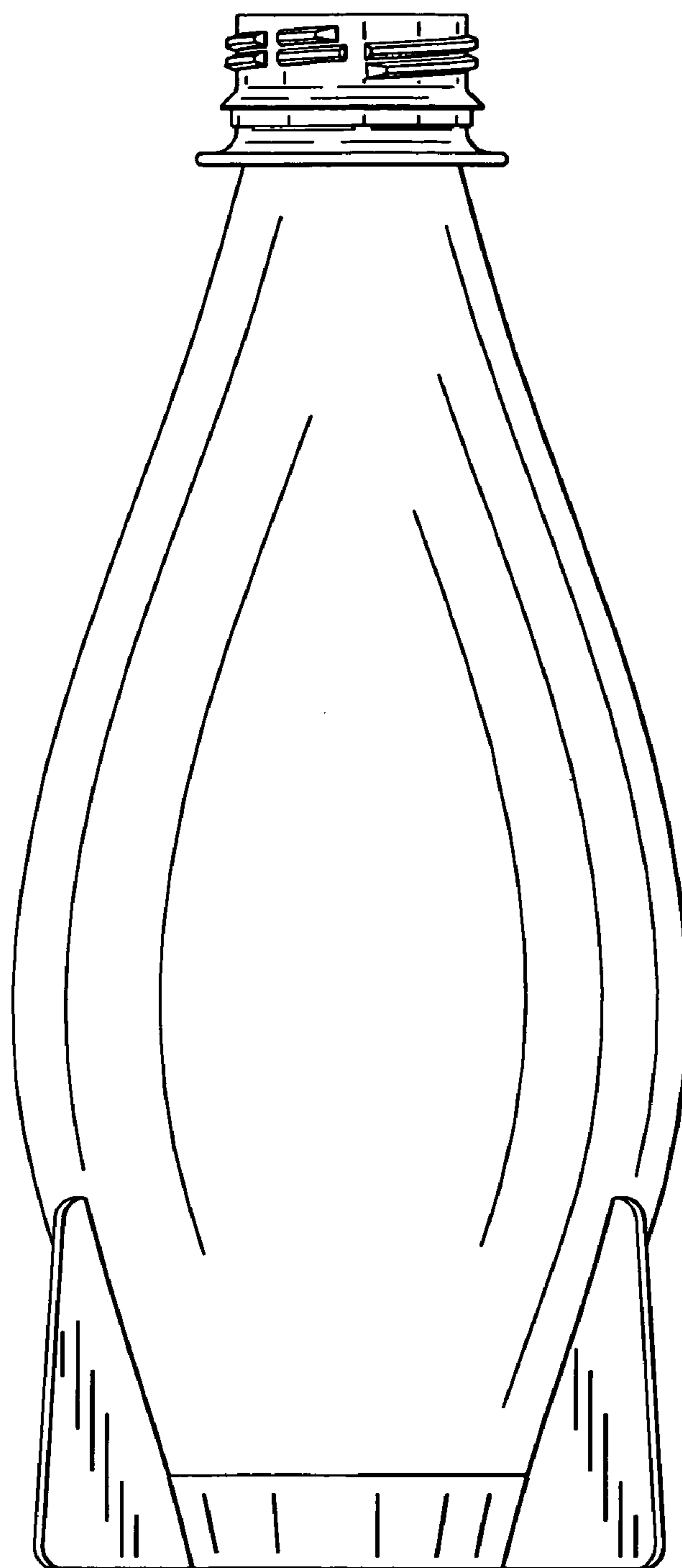

FIG. 2

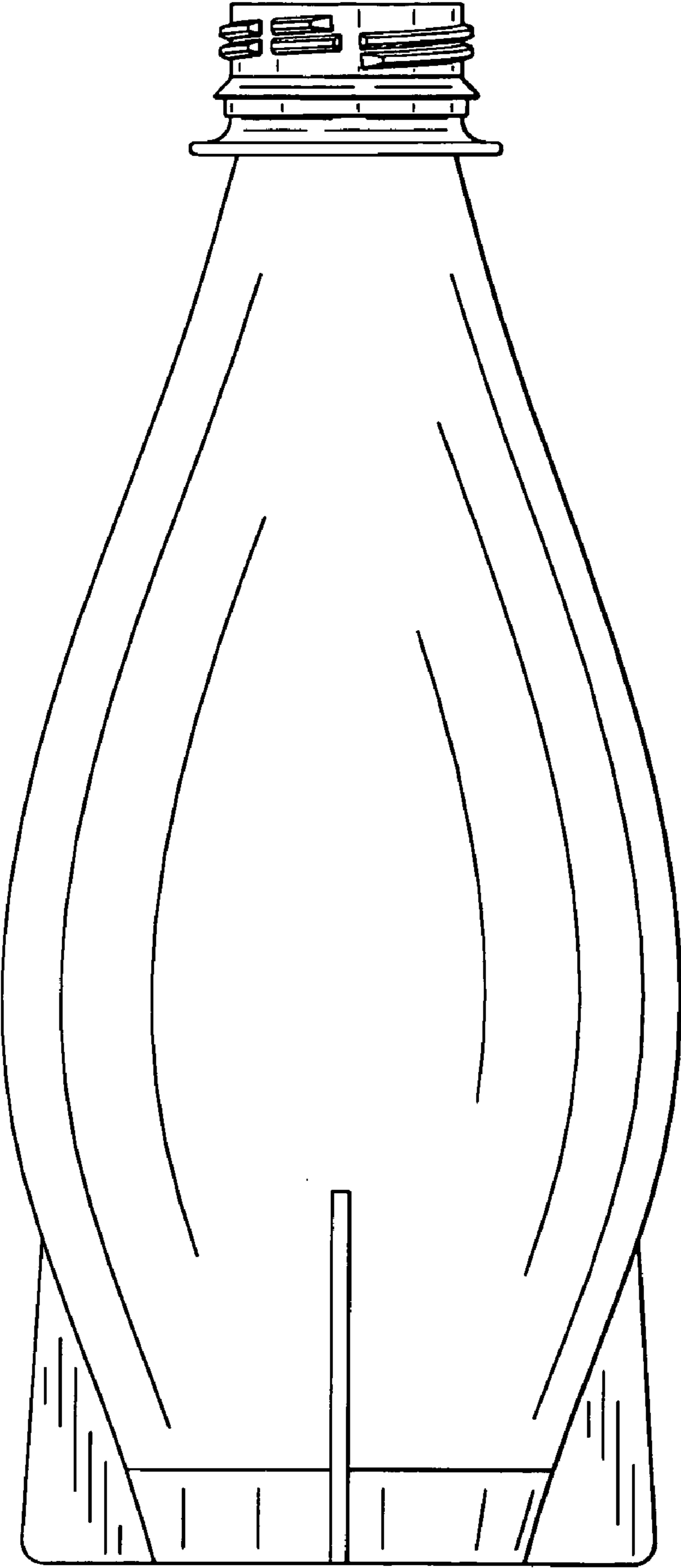

FIG. 3

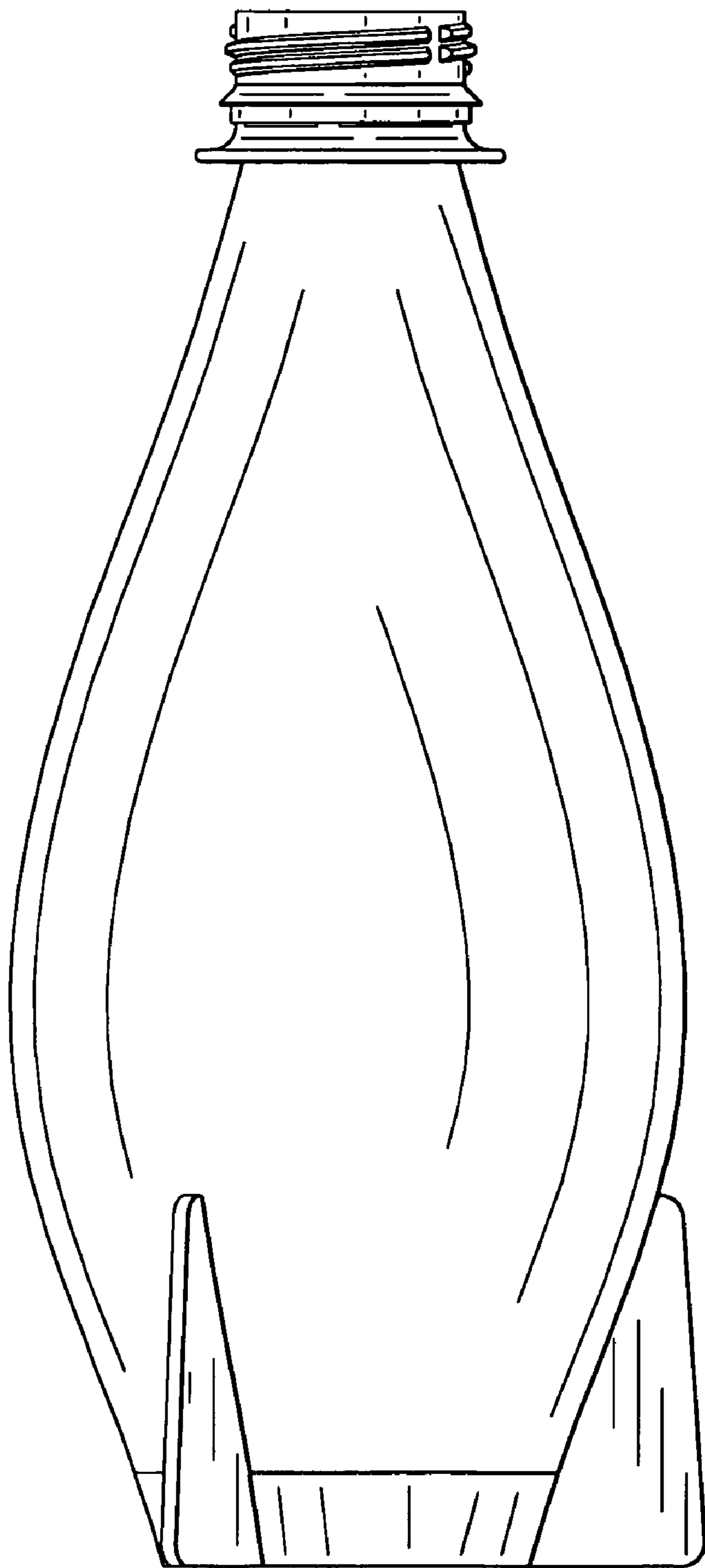

FIG. 4

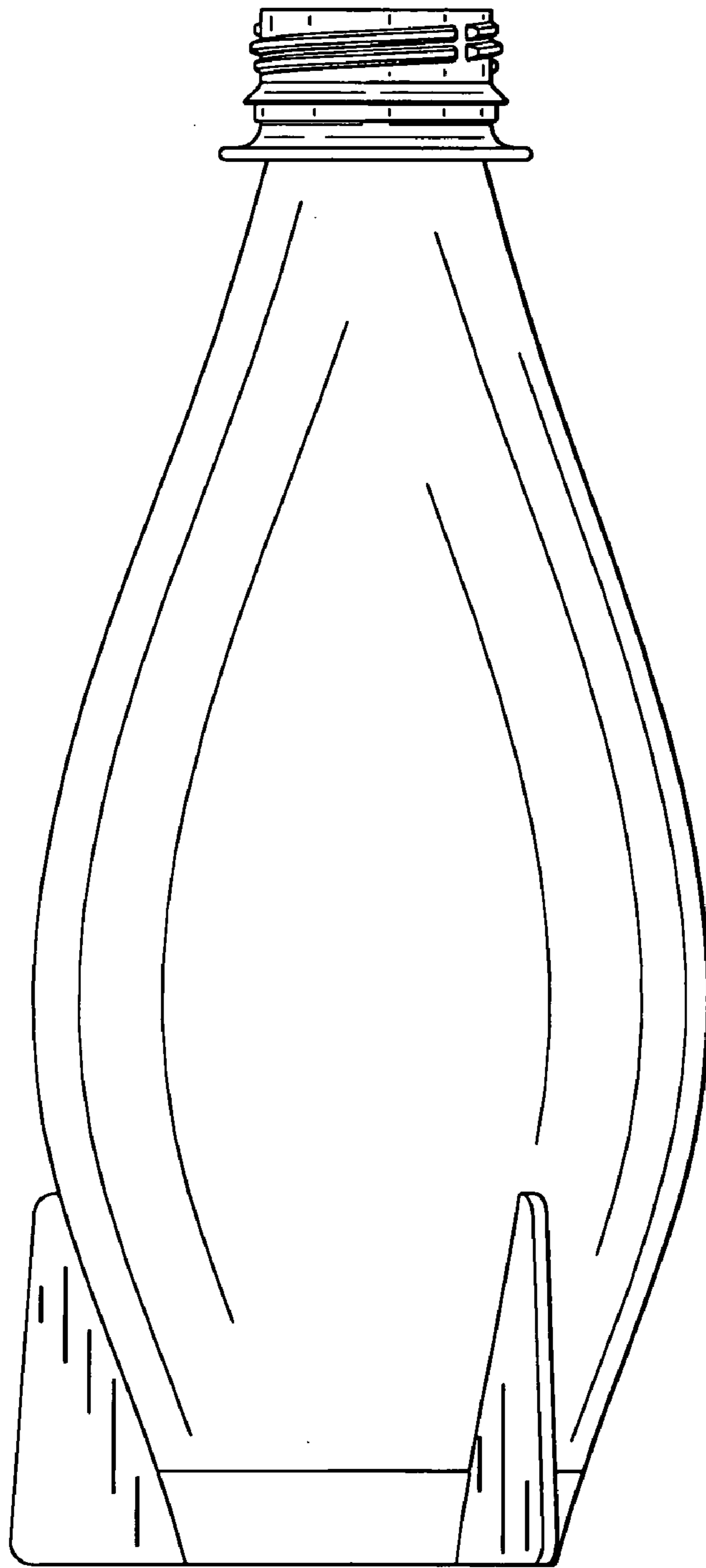

FIG. 5

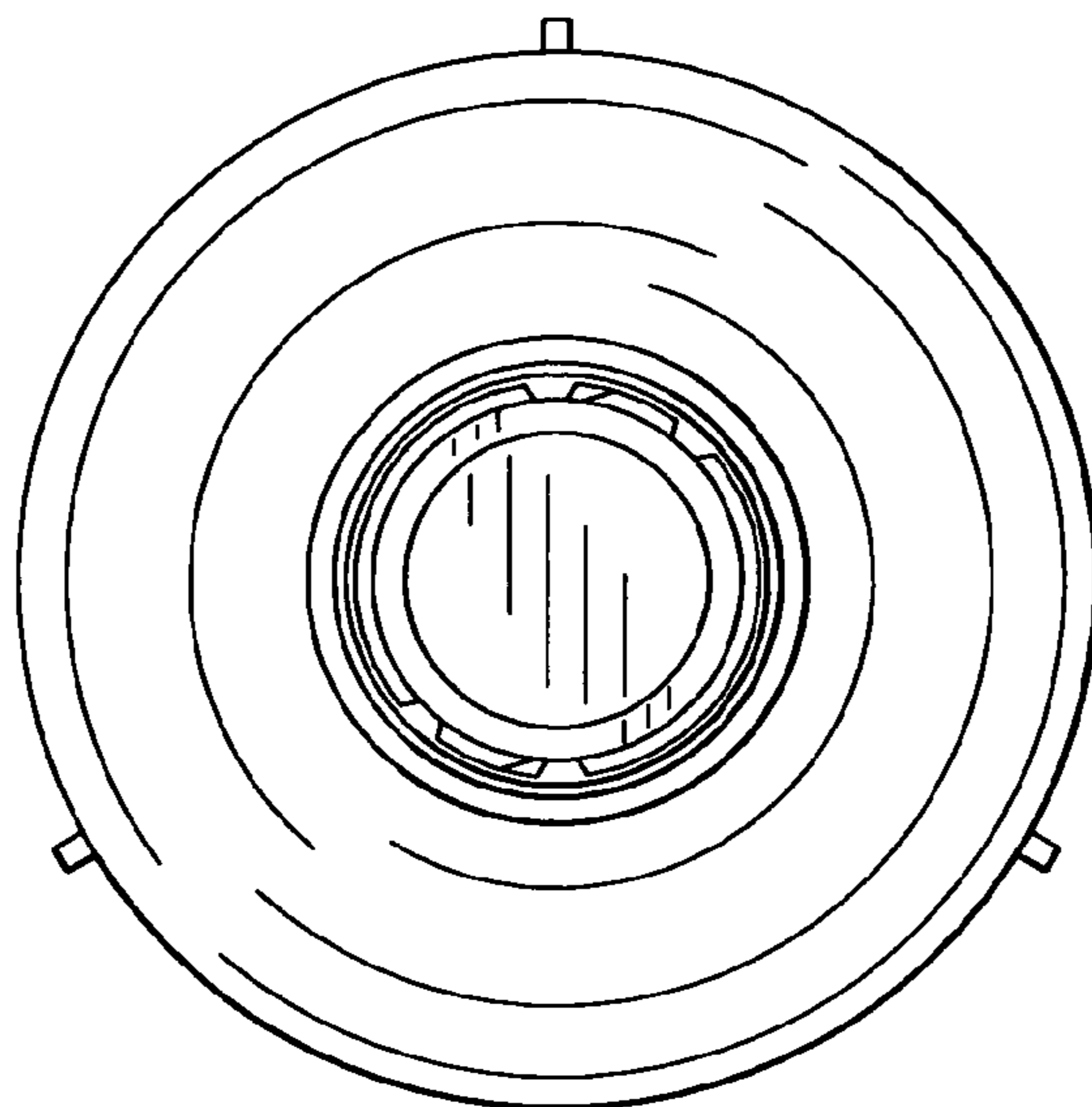

FIG. 6

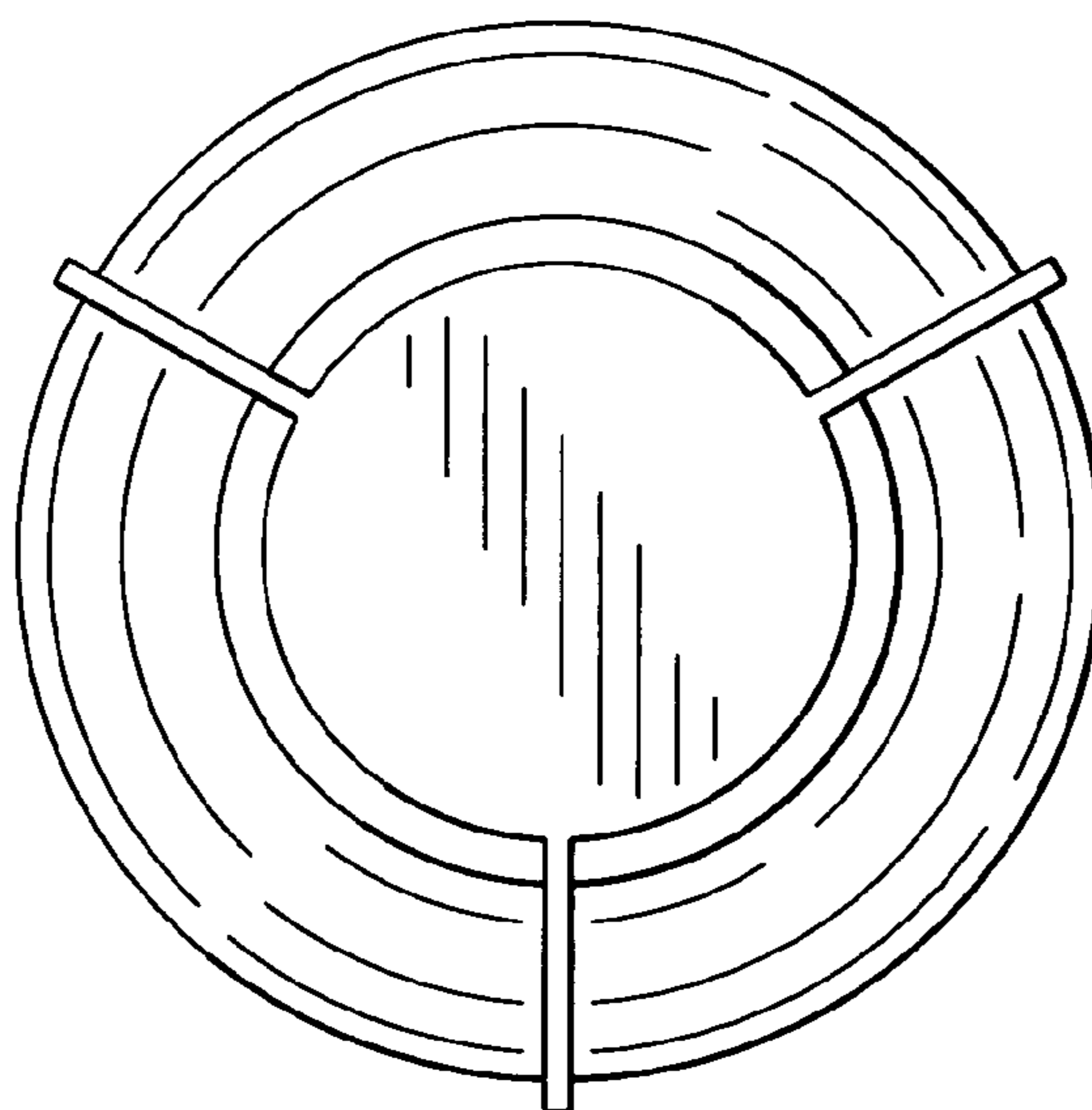

FIG. 7