



US00D604628S

(12) **United States Design Patent**  
**Schultz**

(10) **Patent No.:** **US D604,628 S**

(45) **Date of Patent:** **\*\* Nov. 24, 2009**

(54) **BOTTLE**

(75) Inventor: **Brian Schultz**, Wildwood, MO (US)

(73) Assignee: **Vi-Jon, Inc.**, St. Louis, MO (US)

(\*\*) Term: **14 Years**

(21) Appl. No.: **29/298,464**

(22) Filed: **Dec. 5, 2007**

(51) **LOC (9) Cl.** ..... **09-01**

(52) **U.S. Cl.** ..... **D9/542; D9/563; D9/571;**  
D9/574

(58) **Field of Classification Search** ..... D9/516,  
D9/530, 542-543, 544-547, 563, 571-575;  
215/382-384; 220/660, 669

See application file for complete search history.

(56) **References Cited**

**U.S. PATENT DOCUMENTS**

D37,171 S *	10/1904	Schilling	.....	D9/544
D067,808 S	5/1925	Kammer		
D67,808 S *	7/1925	Kammer	.....	D9/574
D090,216 S	5/1933	Smith		
D90,216 S *	6/1933	Smith	.....	D9/563
D197,487 S *	2/1964	Lorenzen	.....	D9/558
D198,647 S *	7/1964	Roberts	.....	D9/563
D199,276 S *	9/1964	Du Pree	.....	D9/542
D224,203 S *	7/1972	Donoghue	.....	D9/547
D230,709 S	3/1974	Cooper		
D262,778 S *	1/1982	Britt et al.	.....	D9/542
D278,118 S	3/1985	Hoyt		
D294,121 S *	2/1988	Cramer	.....	D9/542
4,802,295 A *	2/1989	Darr	.....	215/383
D322,751 S *	12/1991	Larsen	.....	D9/678
D325,699 S *	4/1992	Segati	.....	D9/571 X
D326,228 S *	5/1992	Stratford et al.	.....	D9/521
D328,029 S	7/1992	Grip		

D336,046 S *	6/1993	Donoghue	.....	D9/547
D343,360 S *	1/1994	Poo	.....	D9/542 X
5,330,081 A *	7/1994	Davenport	.....	222/207
D352,246 S *	11/1994	Samimi et al.	.....	D9/542
D355,128 S *	2/1995	Samimi et al.	.....	D9/542
D360,831 S	8/1995	Boisset		
5,542,585 A *	8/1996	Peters et al.	.....	222/531
D413,266 S	8/1999	Majerowski et al.		
D421,913 S *	3/2000	Meeker et al.	.....	D9/563
D425,795 S	5/2000	Feen		
D498,680 S *	11/2004	Cleary	.....	D9/542
6,964,345 B2 *	11/2005	Wetherell et al.	.....	215/379 X
D535,565 S	1/2007	Pitassi		
D567,096 S *	4/2008	Toh	.....	D9/542

\* cited by examiner

*Primary Examiner*—Carol Rademaker

(74) *Attorney, Agent, or Firm*—Armstrong Teasdale LLP

(57) **CLAIM**

The ornamental design for a bottle, as shown and described.

**DESCRIPTION**

FIG. 1 is perspective view of a bottle in accordance with an embodiment of the present invention.

FIG. 2 is a top view of the bottle shown in FIG. 1.

FIG. 3 is a bottom view of the bottle shown in FIG. 1.

FIG. 4 is a right side view of the bottle shown in FIG. 1.

FIG. 5 is a left side view of the bottle shown in FIG. 1.

FIG. 6 is a front view of the bottle shown in FIG. 1; and,

FIG. 7 is a rear view of the bottle shown in FIG. 1.

The broken line showing a label on the front of the bottle is for illustrative purposes only and does not form a part of the claimed design.

**1 Claim, 2 Drawing Sheets**

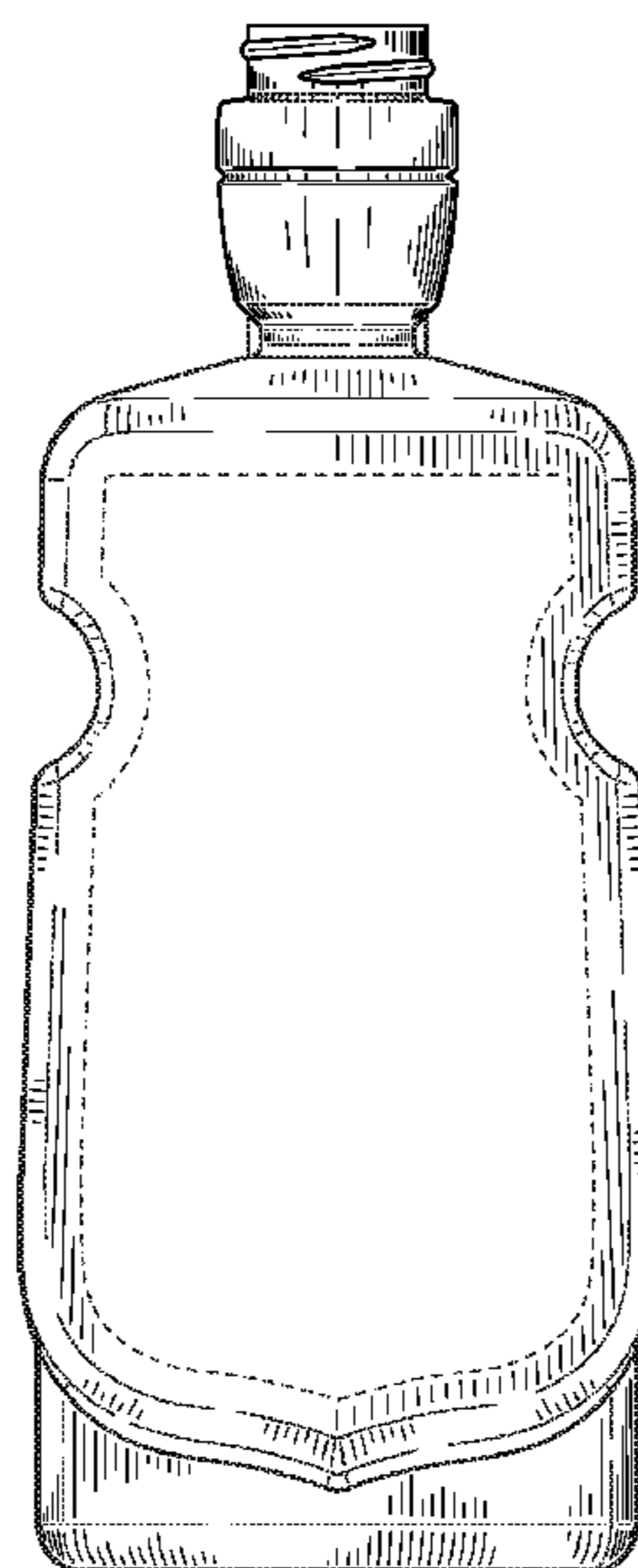
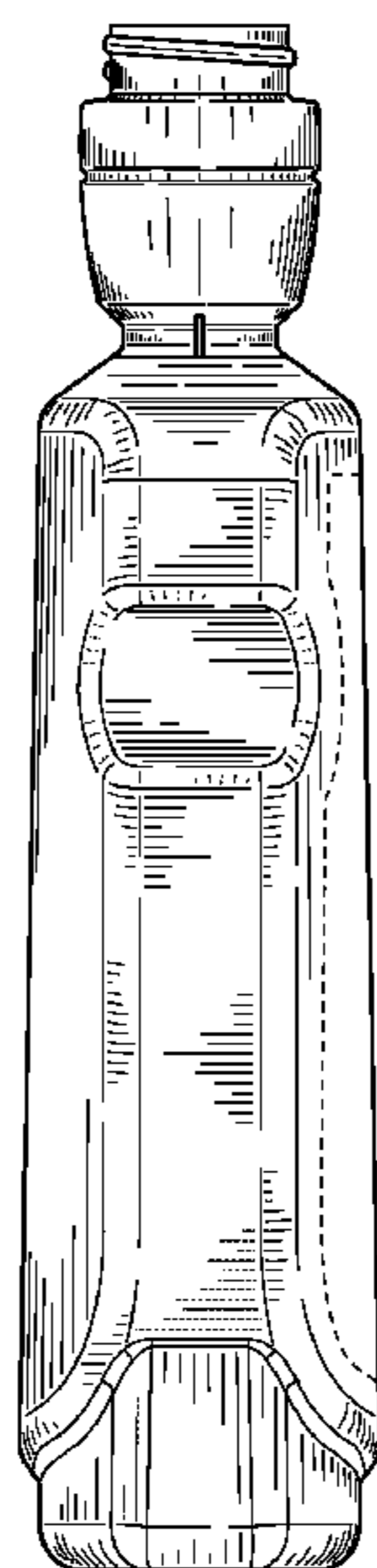

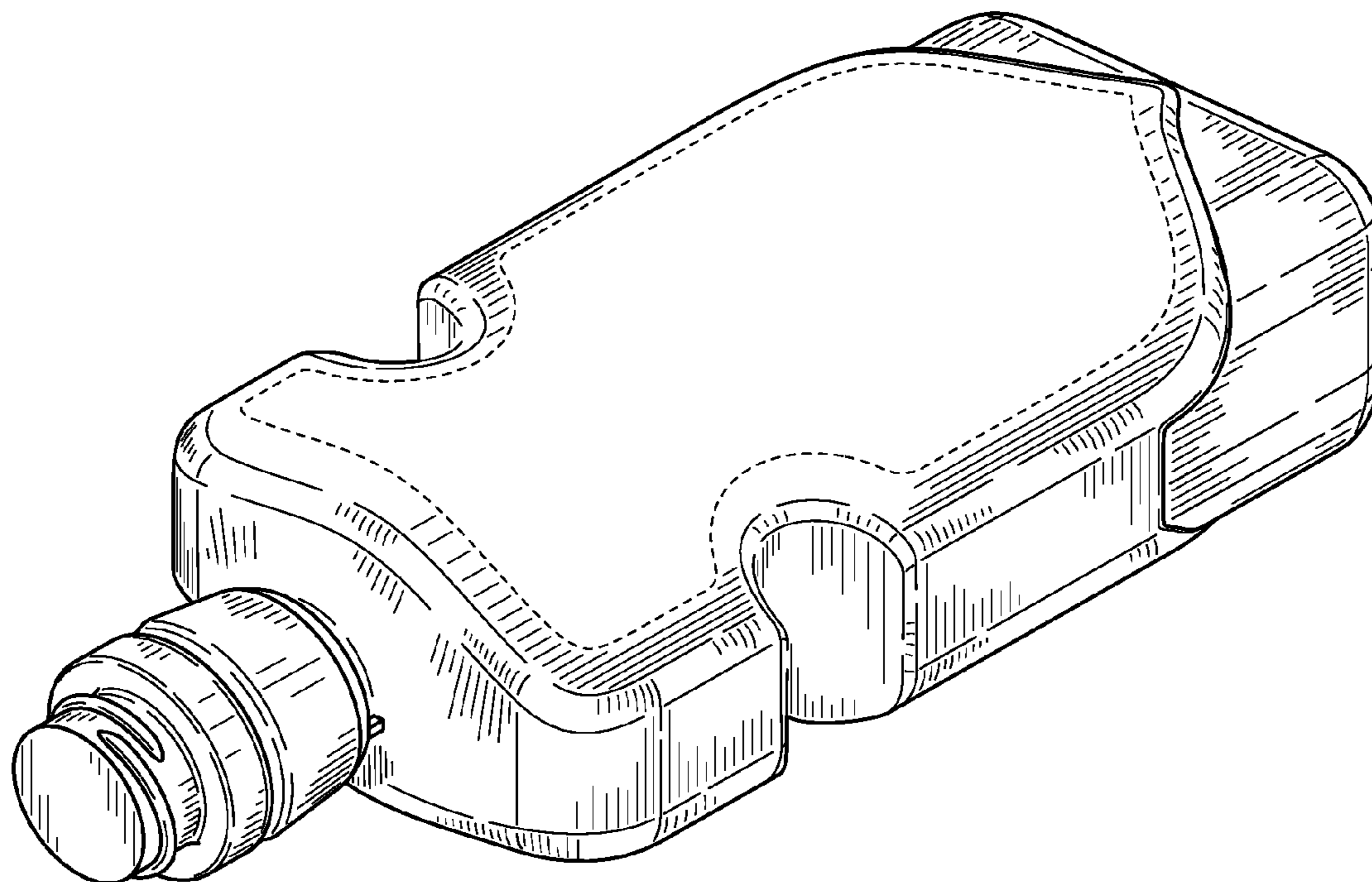

FIG. 1

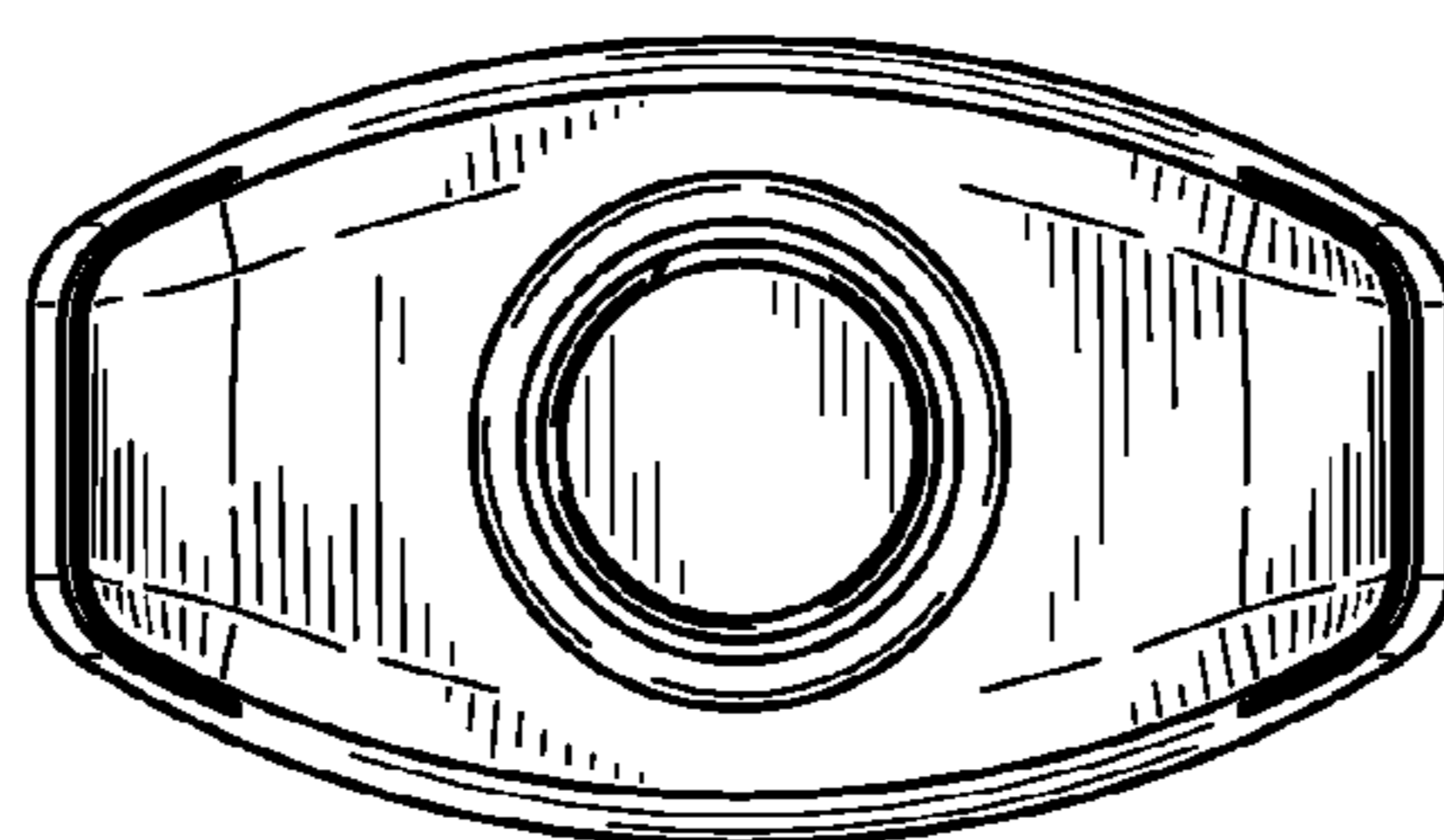

FIG. 2

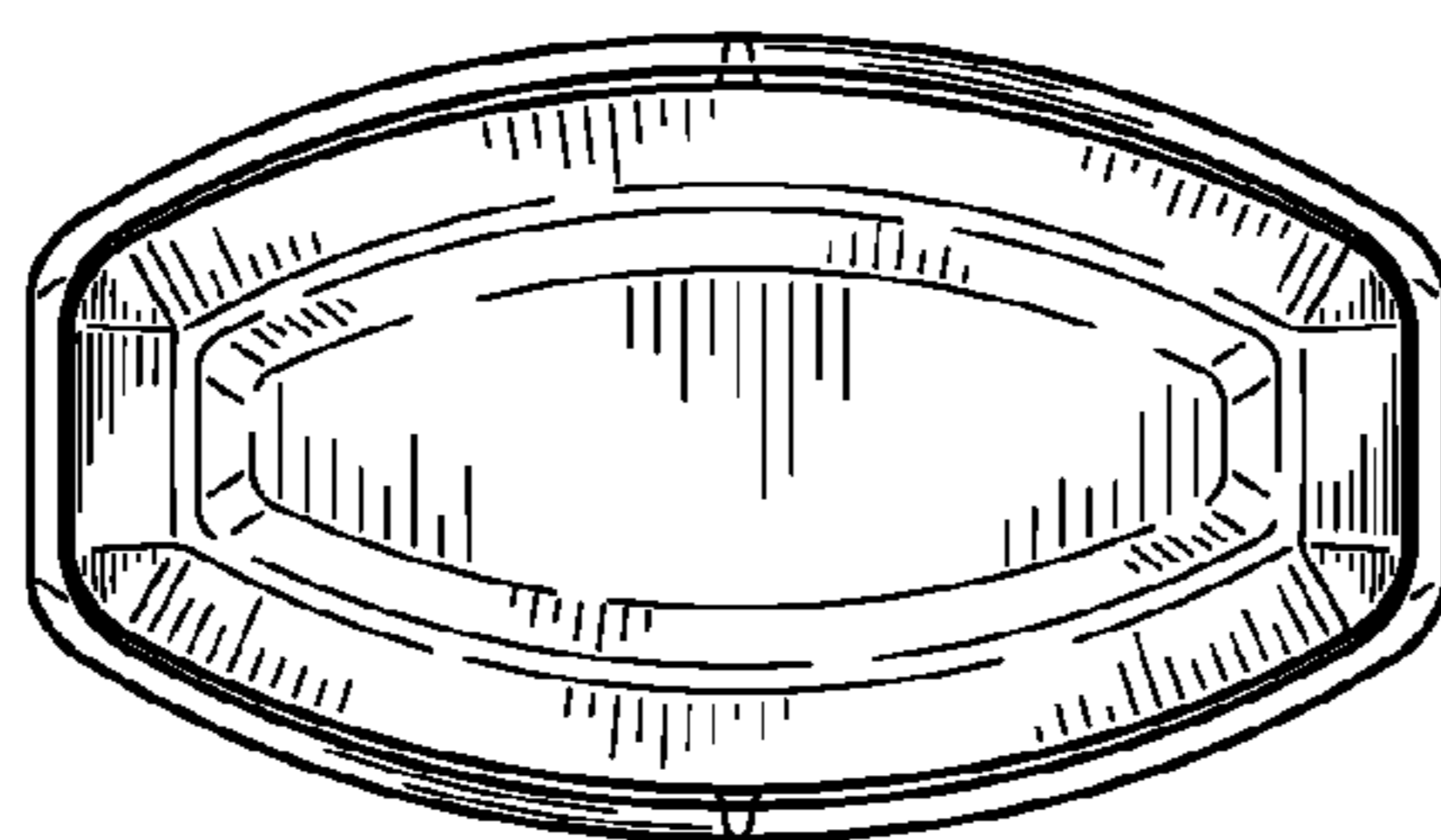

FIG. 3

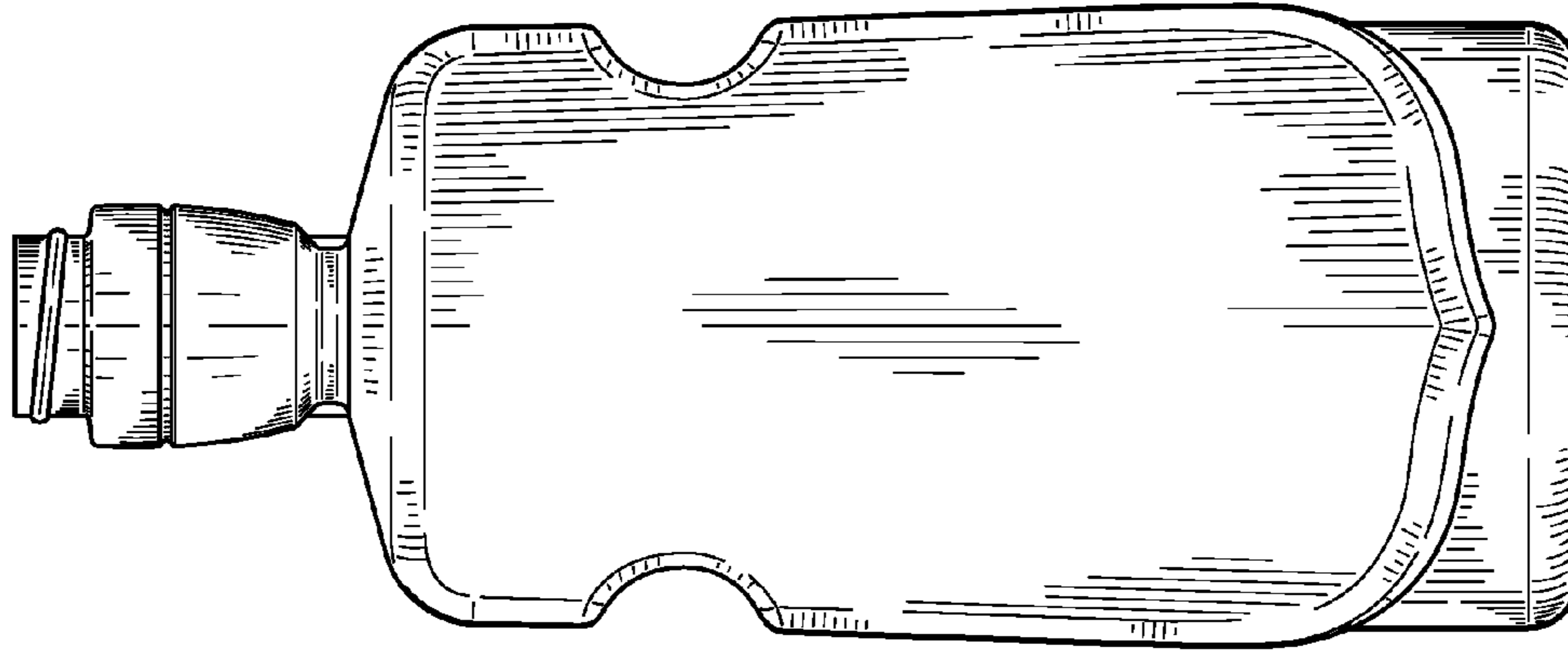

FIG. 7

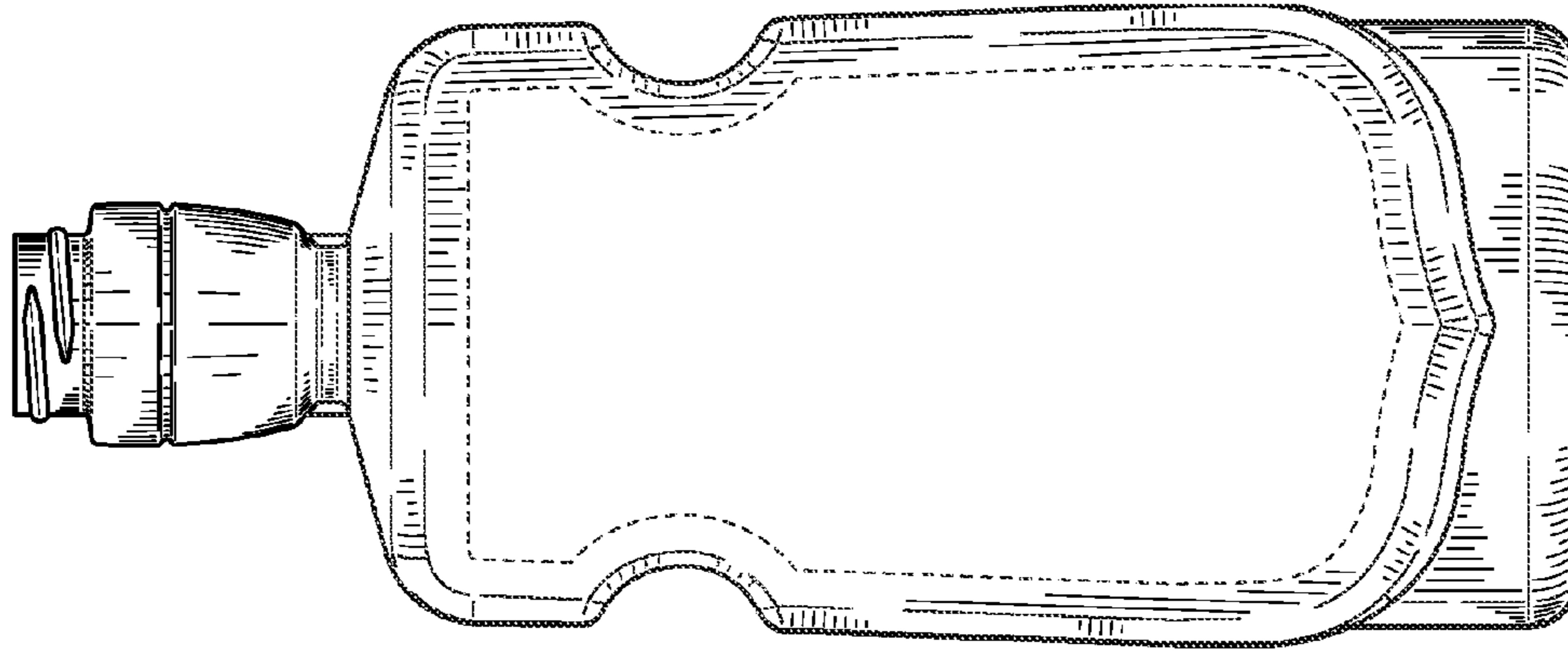

FIG. 6

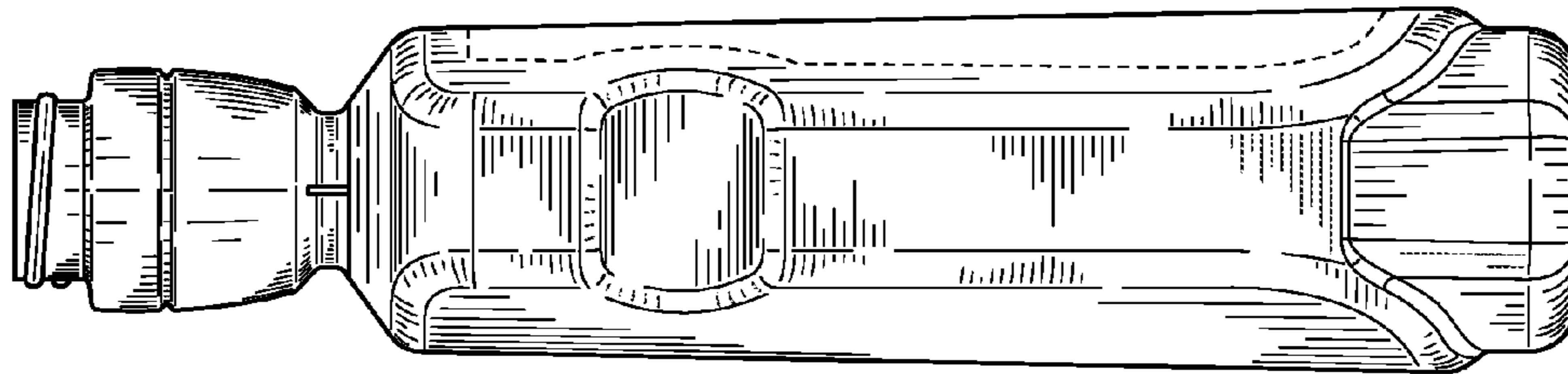

FIG. 5

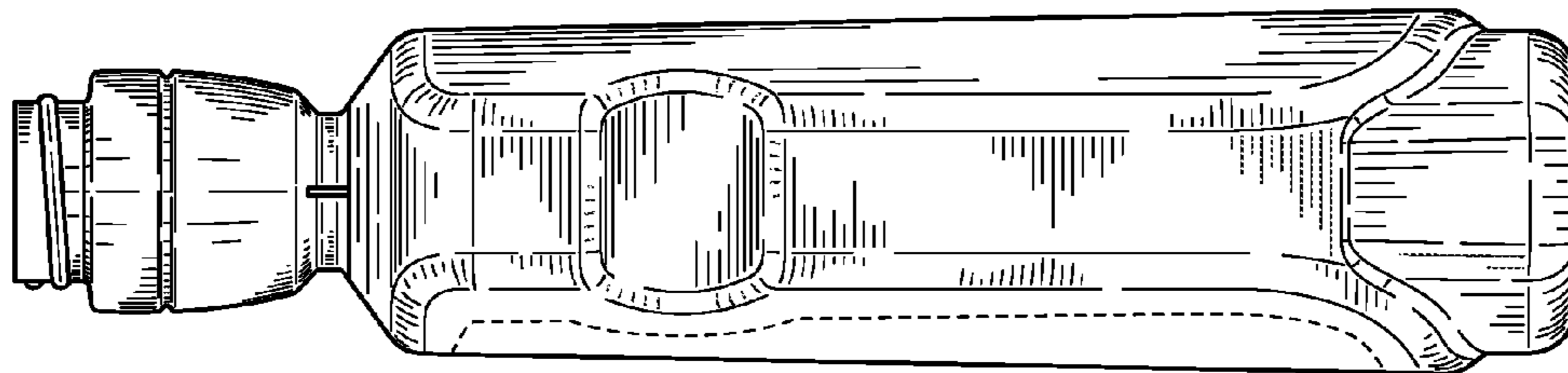

FIG. 4