



US00D604625S

(12) **United States Design Patent**
Lablaine

(10) **Patent No.:** **US D604,625 S**

(45) **Date of Patent:** **** *Nov. 24, 2009**

(54) **BOTTLE**

(75) Inventor: **Nicolas Lablaine**, Chartres (FR)

(73) Assignee: **Reckitt Benckiser N.V.**, Hoofddorp (NL)

(*) Notice: This patent is subject to a terminal disclaimer.

(**) Term: **14 Years**

(21) Appl. No.: **29/332,766**

(22) Filed: **Feb. 25, 2009**

(30) **Foreign Application Priority Data**

Aug. 8, 2006 (EM) 000573712
Jan. 11, 2007 (EM) 000651328/0005

(51) **LOC (9) Cl.** **09-01**

(52) **U.S. Cl.** **D9/541; D9/542; D9/564; D9/574**

(58) **Field of Classification Search** D9/516,
D9/530, 537-543, 549, 552, 564-565, 574,
D9/600; D21/455, 447-458; D23/379; 215/382-384;
222/212; 446/217, 236

See application file for complete search history.

(56) **References Cited**

U.S. PATENT DOCUMENTS

1,549,110 A * 8/1925 Greger 446/217
1,769,784 A * 7/1930 Hoppe 446/217
D102,283 S * 12/1936 Marrow D9/539

(Continued)

Primary Examiner—Carol Rademaker

(74) *Attorney, Agent, or Firm*—Norris, McLaughlin & Marcus, P.A.

(57) **CLAIM**

The ornamental design for a bottle, as shown and described.

DESCRIPTION

FIG. 1 is a front perspective view of a first embodiment my bottle;

FIG. 2 is a front elevational view of the first embodiment thereof;

FIG. 3 is a rear elevational view of the first embodiment thereof;

FIG. 4 is right side elevational view of the first embodiment thereof, the left side elevational view being a mirror image;

FIG. 5 is a plan view of the top of the first embodiment thereof;

FIG. 6 is a plan view of the bottom of the first embodiment thereof;

FIG. 7 is a front perspective view of a second embodiment of my bottle;

FIG. 8 is a front elevational view of the second embodiment thereof;

FIG. 9 is a rear elevational view of the second embodiment thereof;

FIG. 10 is a right side elevational view of the second embodiment thereof, the left side elevational view being a mirror image;

FIG. 11 is a plan view of the top of the second embodiment thereof; and,

FIG. 12 is a plan view of the bottom of the second embodiment thereof.

The broken lines shown in the drawing views are included for the purpose of showing environmental structure that forms no part of the claimed design.

1 Claim, 4 Drawing Sheets

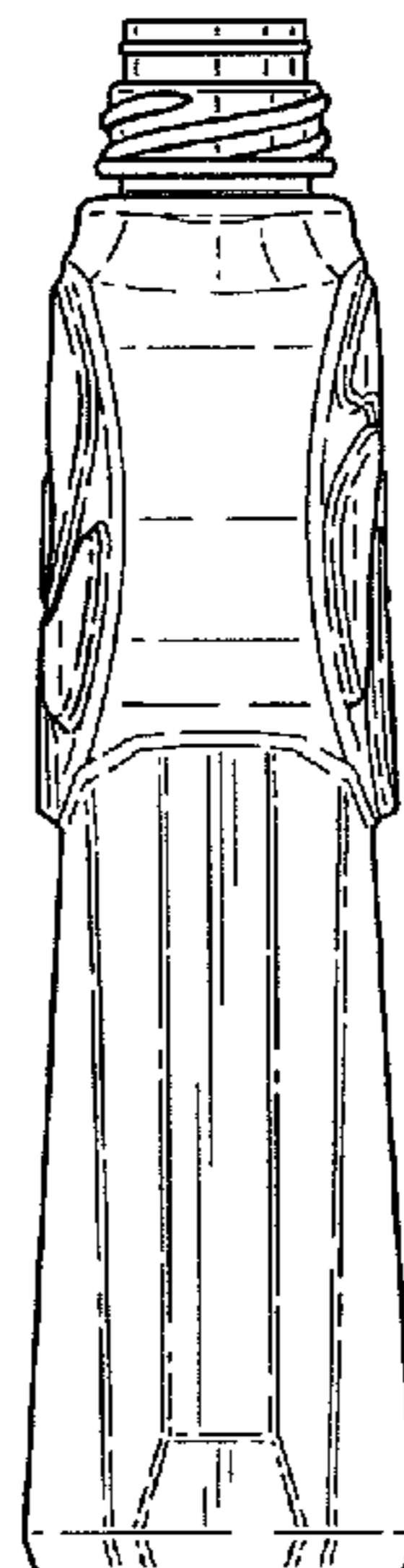
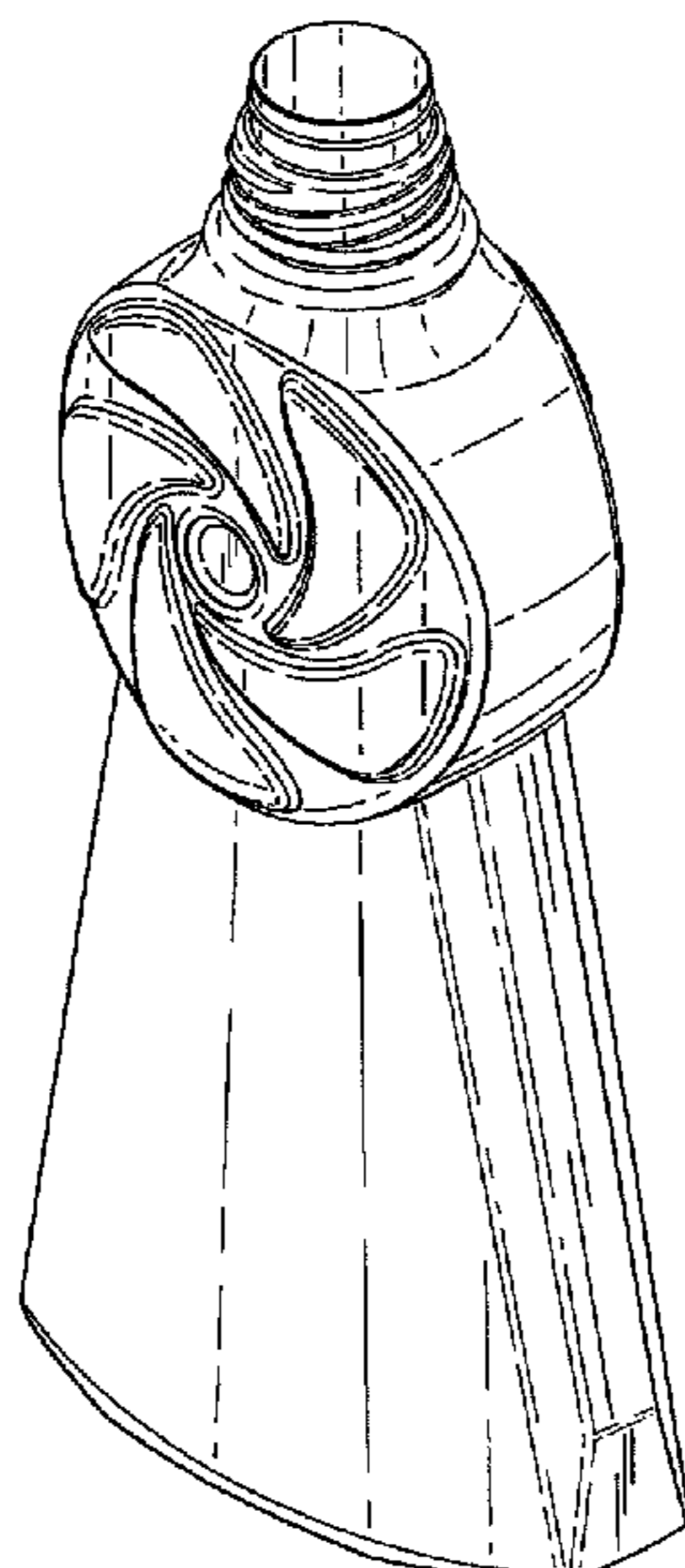

US D604,625 S

Page 2

U.S. PATENT DOCUMENTS

2,510,336	A *	6/1950	Donahue	446/217	D281,616	S *	12/1985	McGuire	D21/457
D169,111	S *	3/1953	Smith	D9/542	D325,701	S *	4/1992	van Lit	D9/564
D210,650	S *	4/1968	Douglas	D9/530	5,542,585	A *	8/1996	Peters et al.	222/531
D222,611	S *	11/1971	Strand	D9/542	5,836,800	A *	11/1998	Liu	446/236
D257,364	S *	10/1980	Molenaar	D21/458	D528,923	S *	9/2006	Nicoletti	D9/542
D259,246	S *	5/1981	Brandt et al.	D9/542	D541,660	S *	5/2007	Mayers	D9/574 X
4,349,134	A *	9/1982	Schuster et al.	222/212	D559,968	S *	1/2008	Lee et al.	D23/379
D273,732	S *	5/1984	Tiffany	D6/335	D570,692	S *	6/2008	Finn	D9/516

* cited by examiner

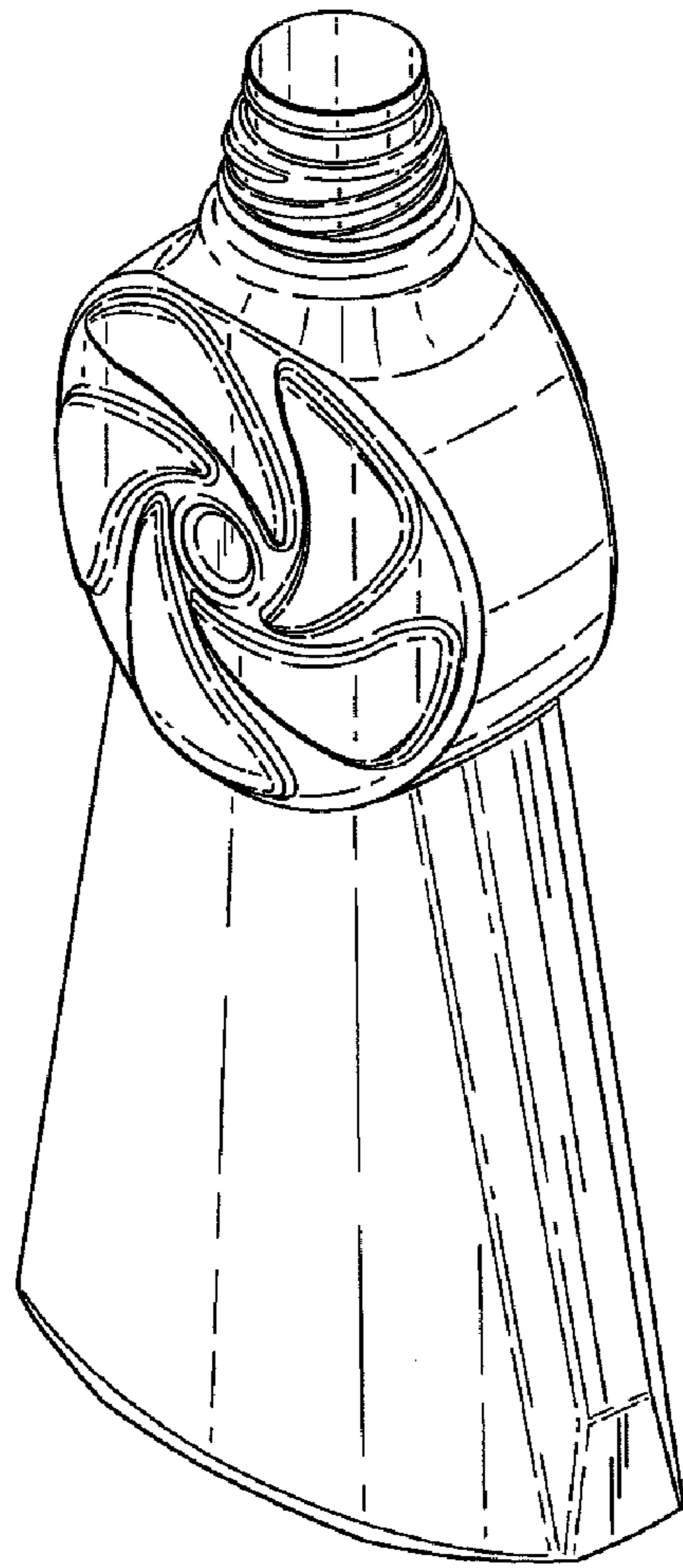

Fig. 1.

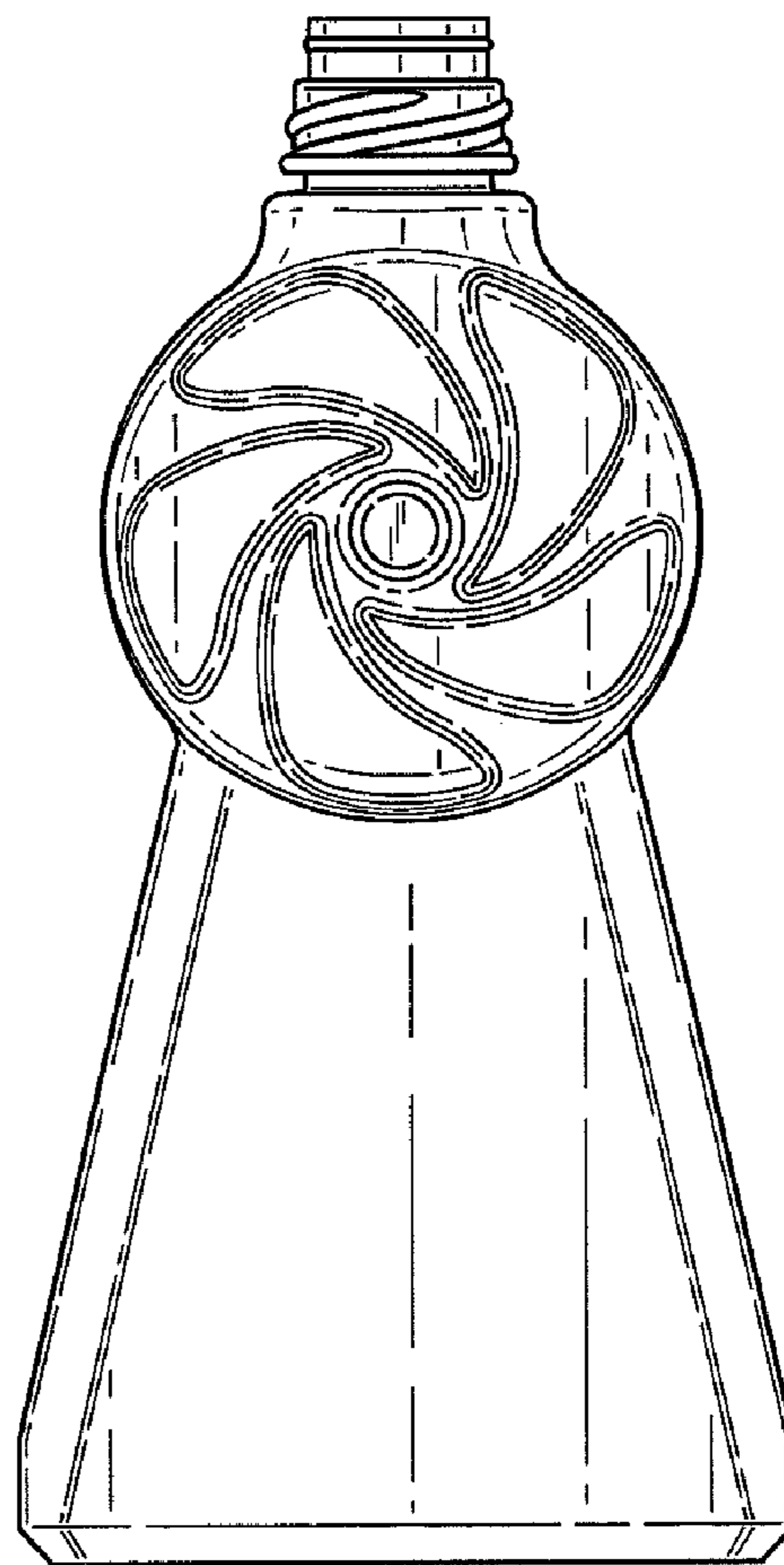

Fig. 2.

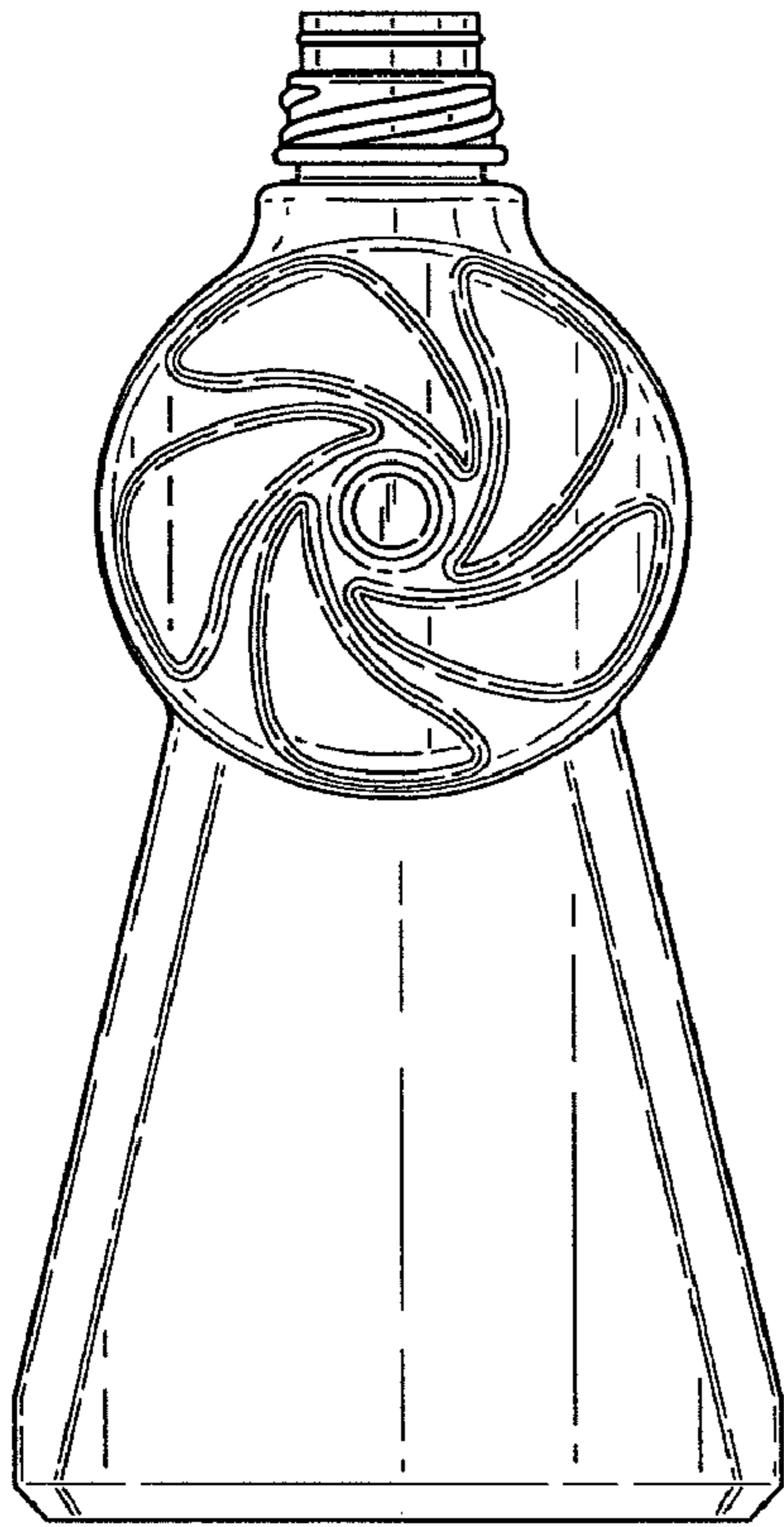

Fig.3.

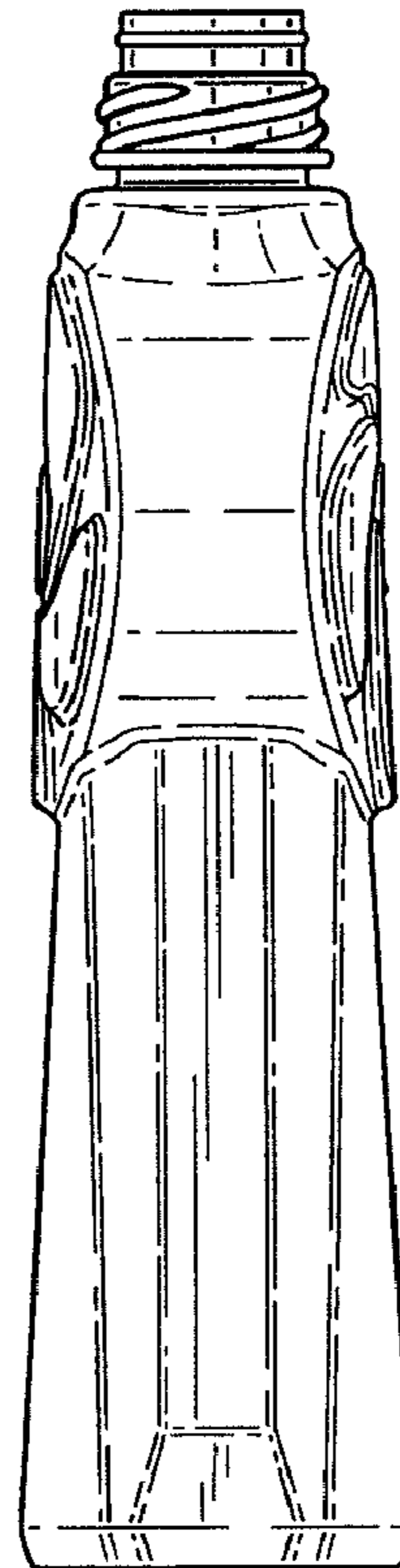

Fig.4.

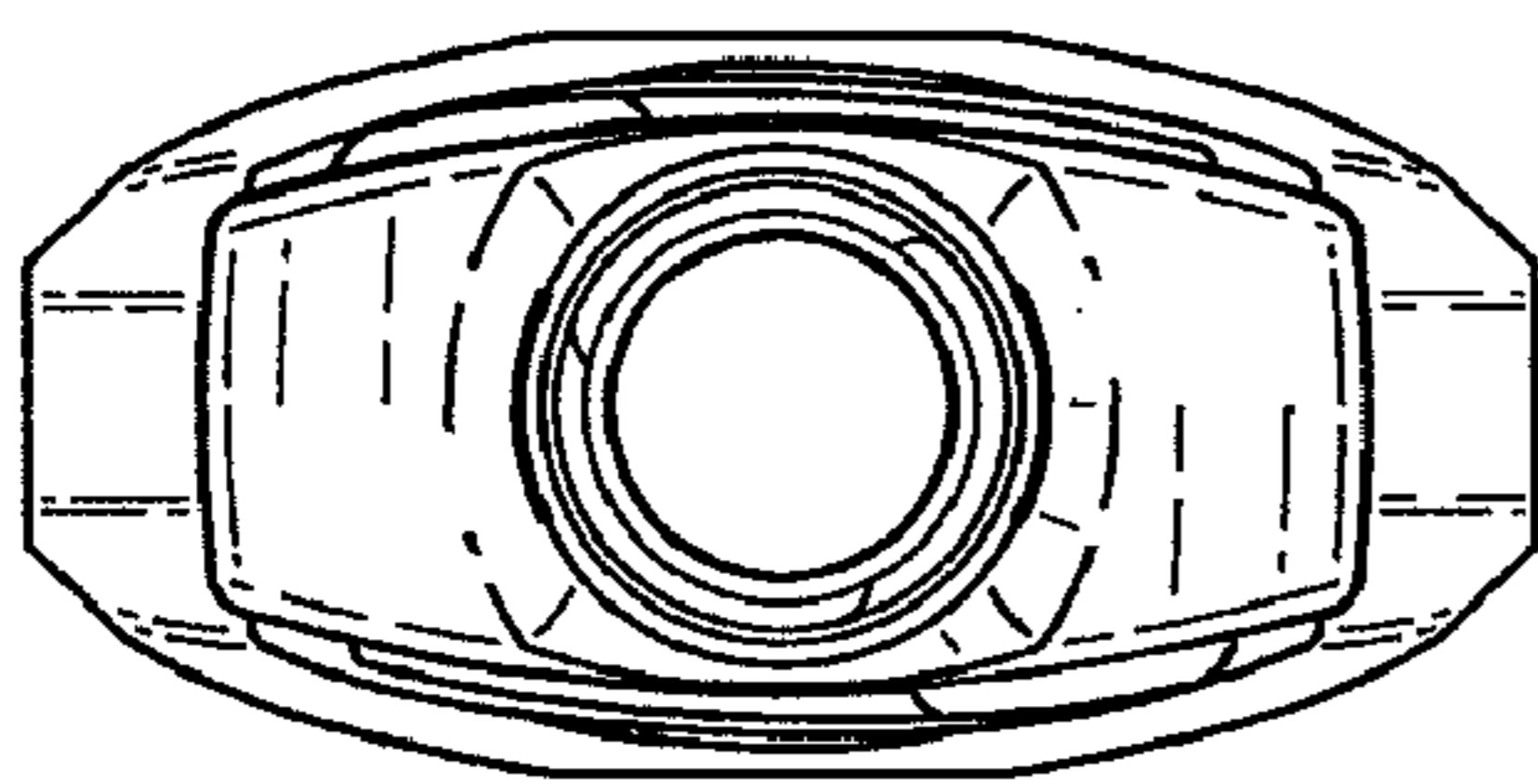

Fig.5.

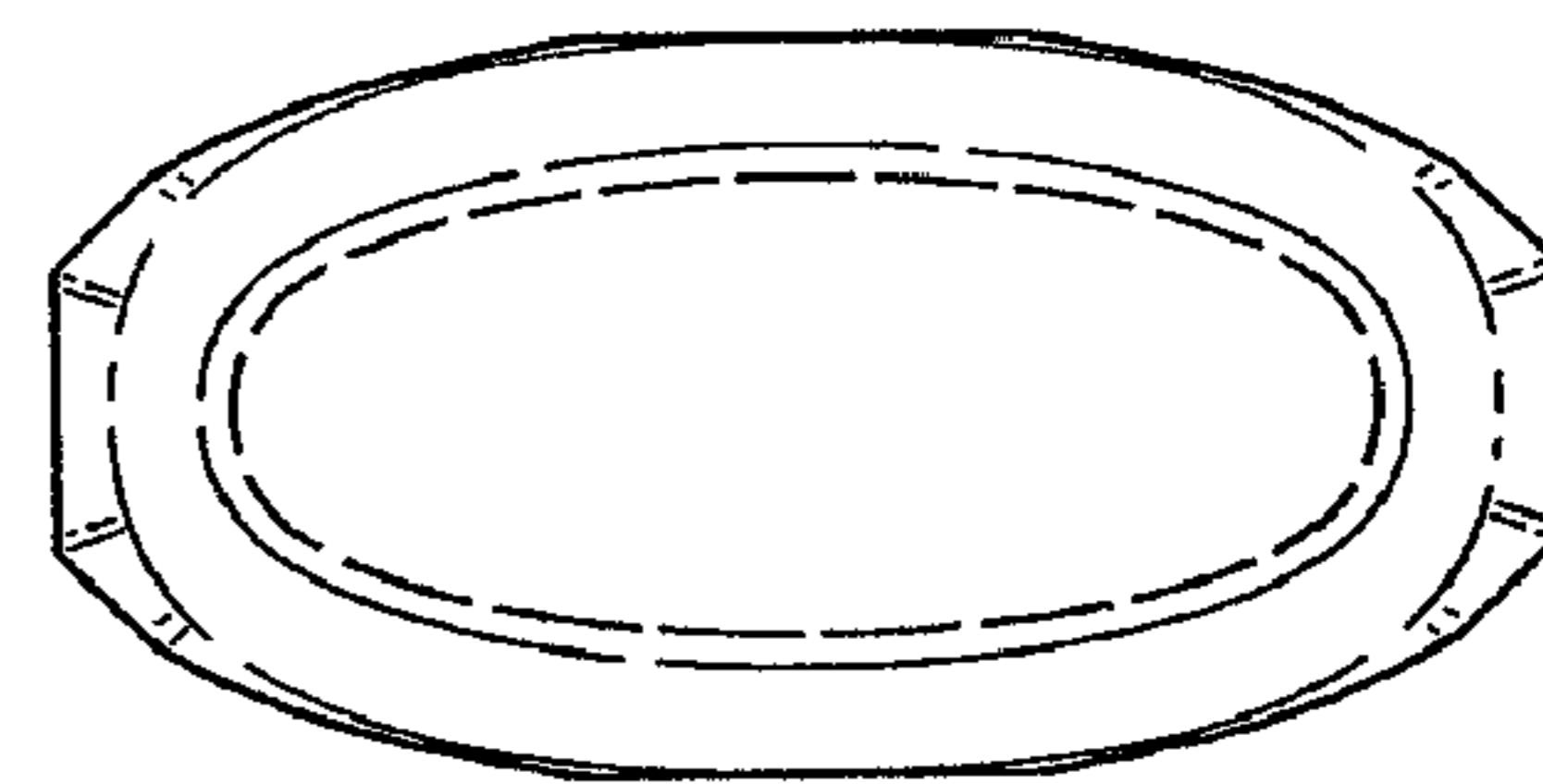

Fig.6.

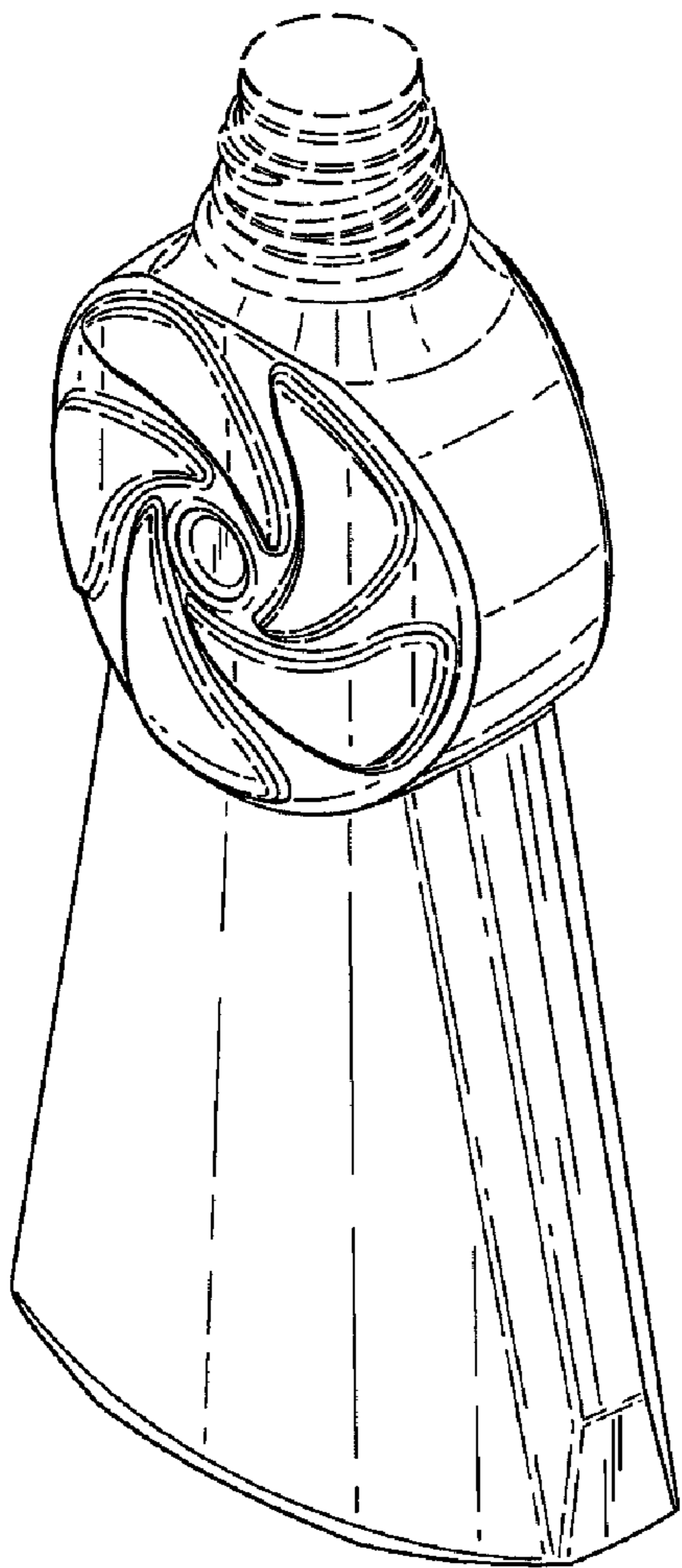

Fig. 7.

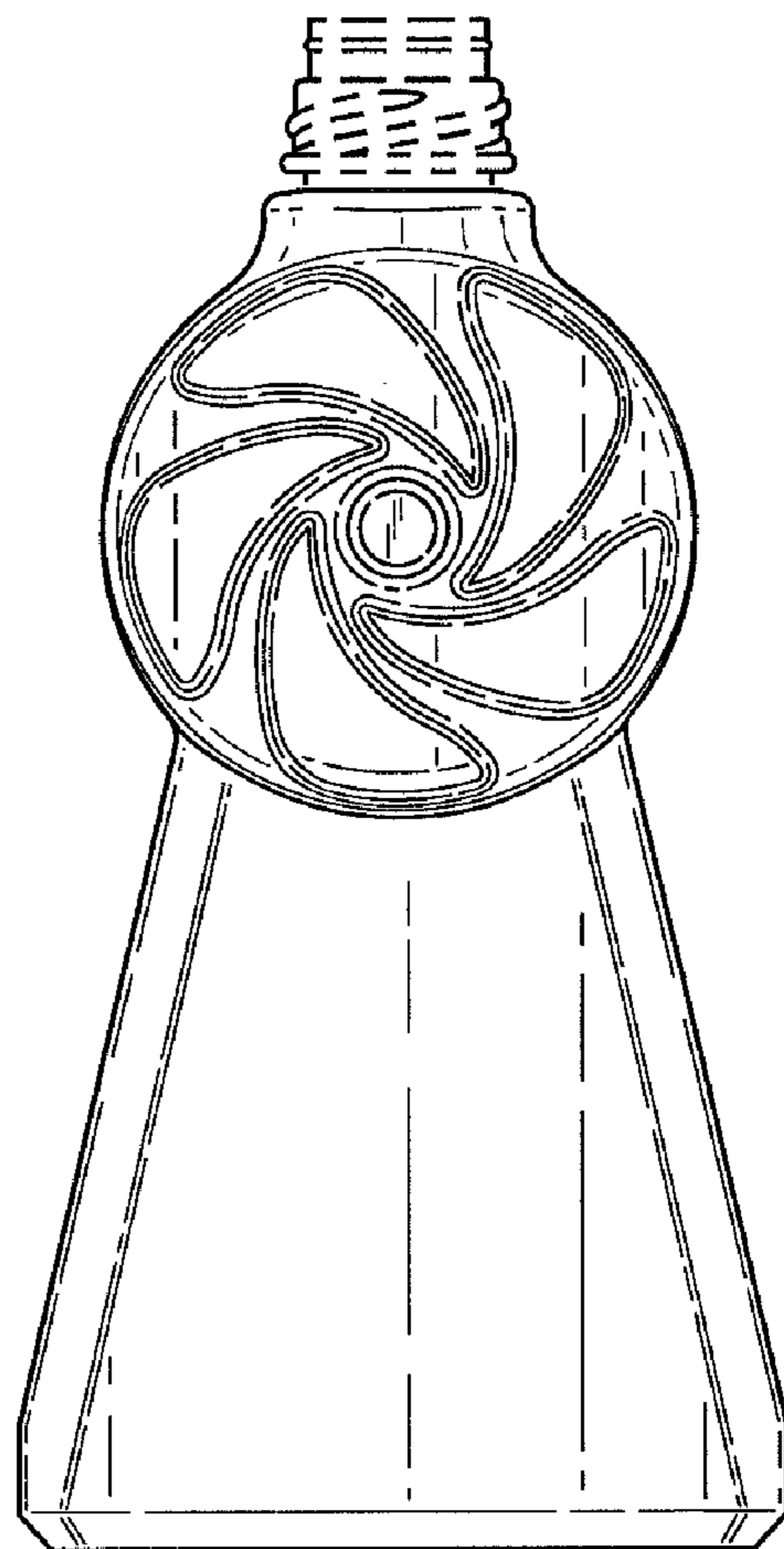

Fig. 8.

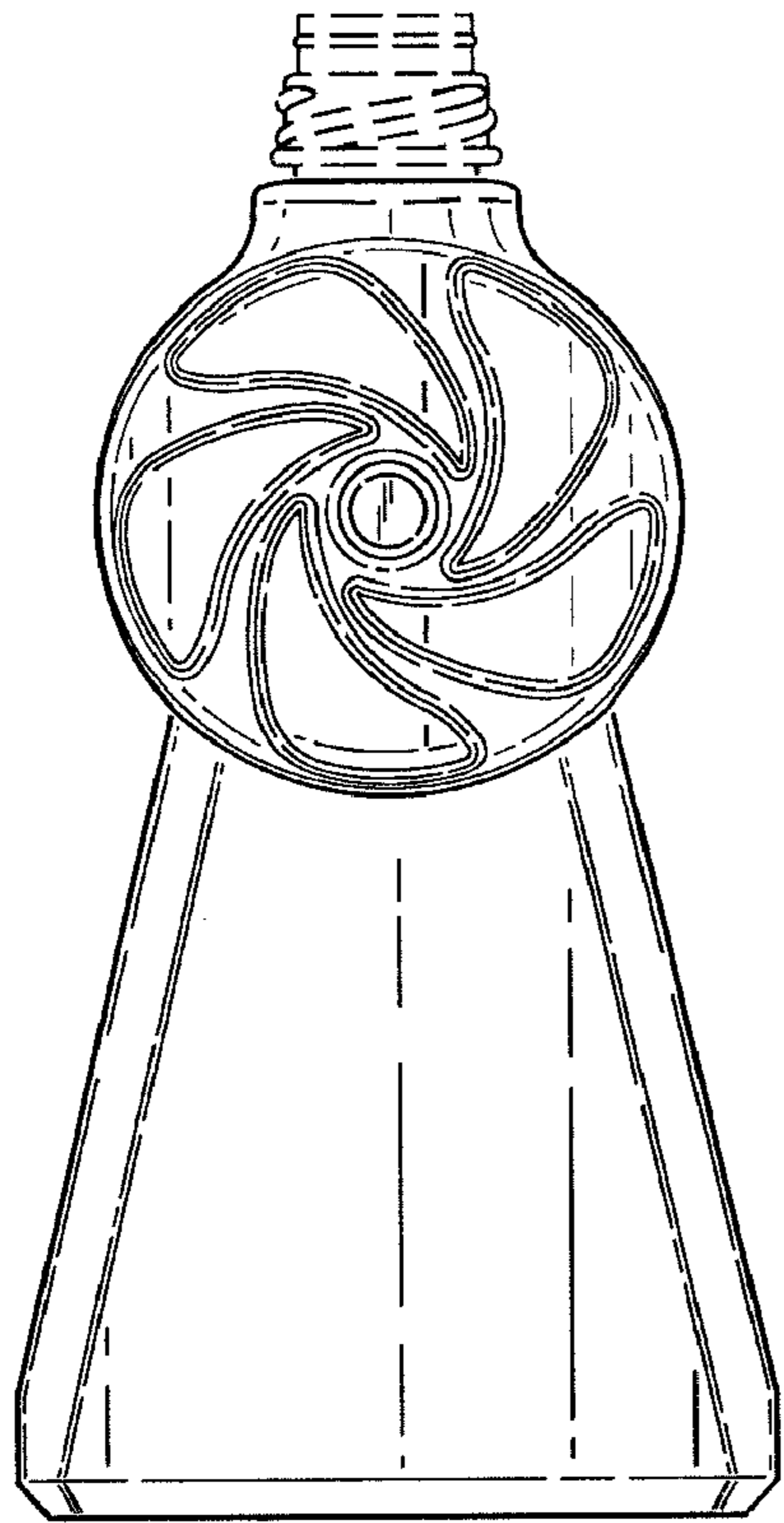

Fig.9.

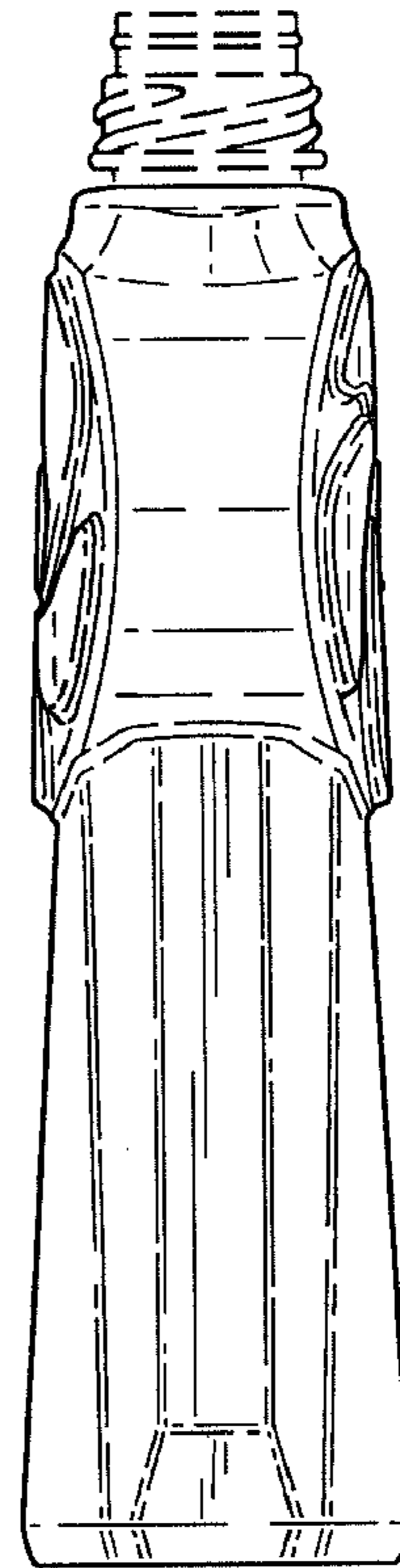

Fig.10.

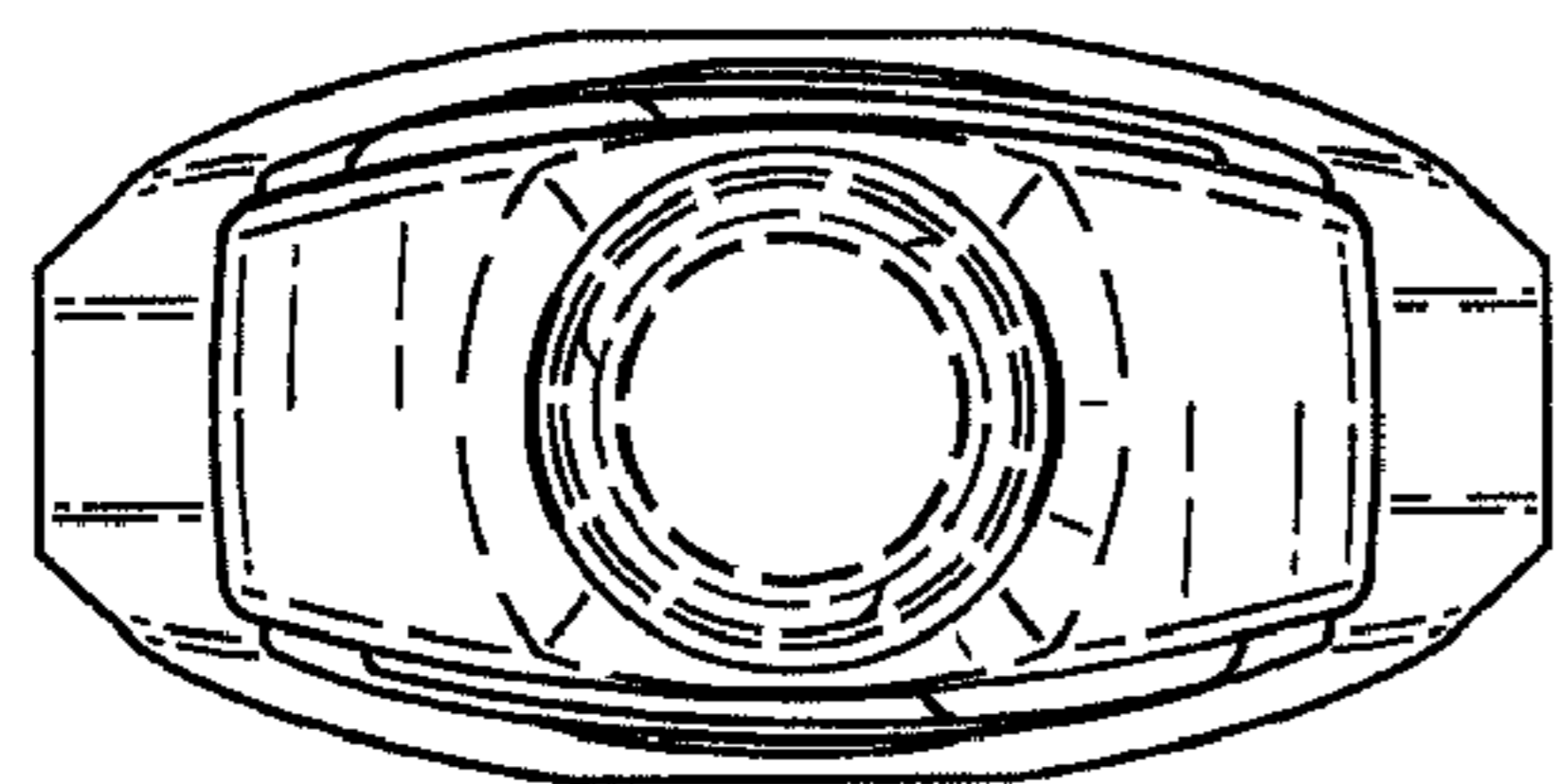

Fig.11.

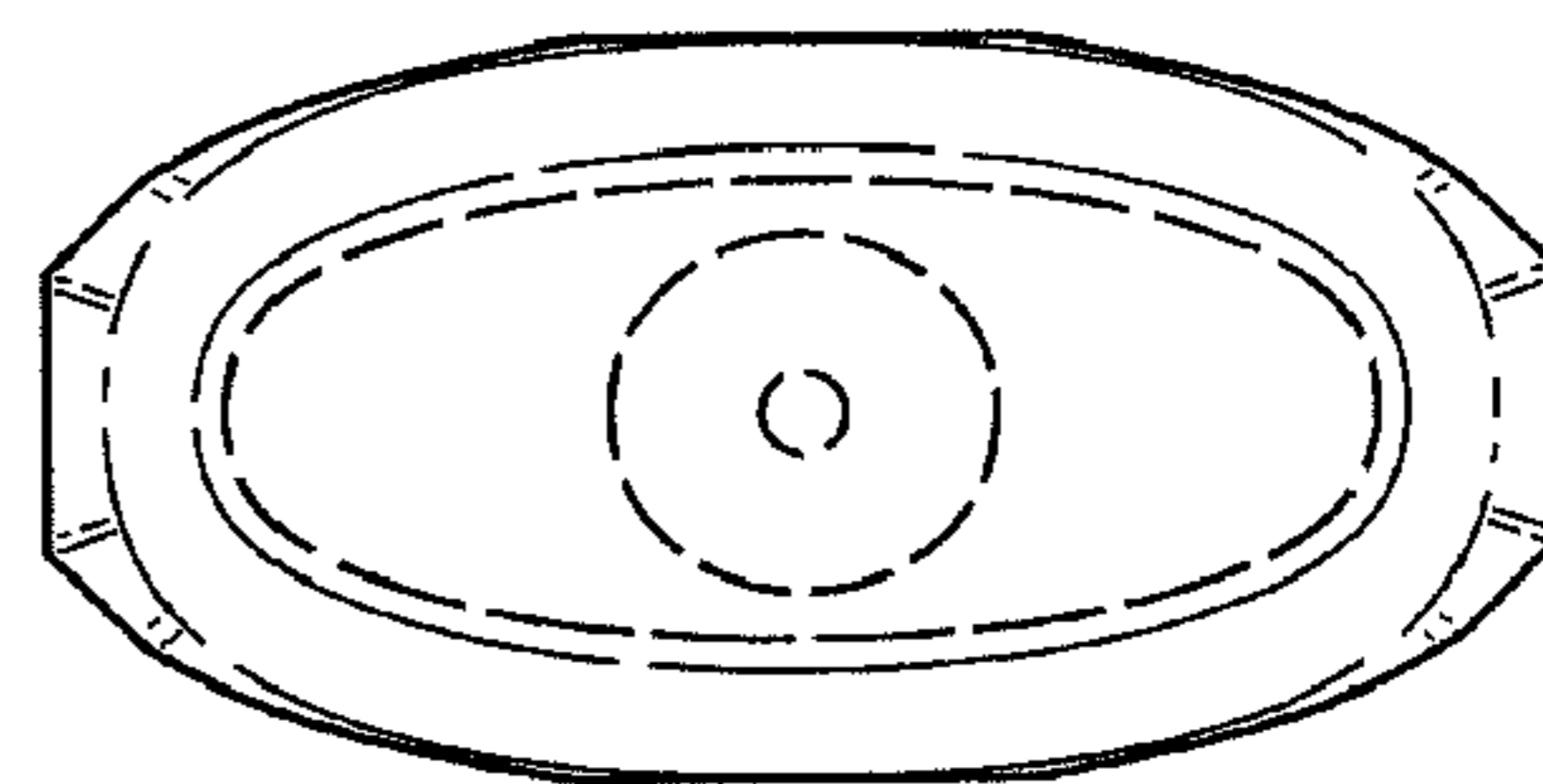

Fig.12.