



US00D604599S

(12) **United States Design Patent**
Prichard, Jr. et al.

(10) **Patent No.:** **US D604,599 S**
(45) **Date of Patent:** **** Nov. 24, 2009**

(54) **BISCUIT DECK FASTENER**

7,578,105 B2 * 8/2009 Eberle, III 52/403.1
D600,105 S * 9/2009 Harris D8/382

(76) Inventors: **William Jacob Prichard, Jr.**, 26086
Wyndham Rd., Sturgis, MI (US) 49091;
Randal L. Johnson, 25890 Mintdale
Rd., Sturgis, MI (US) 49091

(**) Term: **14 Years**

(21) Appl. No.: **29/314,028**

(22) Filed: **Feb. 27, 2009**

(51) **LOC (9) Cl.** **08-08**

(52) **U.S. Cl.** **D8/382**

(58) **Field of Classification Search** D8/382,
D8/349, 354; 403/231, 232.1, 408.1, 483.1;
411/458; 52/480, 489.2

See application file for complete search history.

(56) **References Cited**

U.S. PATENT DOCUMENTS

5,560,117	A *	10/1996	Tallman	33/526
D481,281	S *	10/2003	Anderson	D8/71
D485,160	S *	1/2004	Pelc	D8/382
7,052,200	B2 *	5/2006	Harris	403/231
D547,169	S *	7/2007	Harris	D8/382
D562,119	S *	2/2008	Prichard et al.	D8/382
D568,147	S *	5/2008	Prichard et al.	D8/382
D585,269	S *	1/2009	Prichard et al.	D8/382

OTHER PUBLICATIONS

U.S. Appl. No. 29/314,029, Applicant: William Jacob Prichard, Jr., et al., filed Feb. 27, 2009 entitled Biscuit Deck Fastener.

* cited by examiner

Primary Examiner—Holly H Baynham

Assistant Examiner—Sheryl Lane

(74) *Attorney, Agent, or Firm*—Flynn, Thiel, Boutell & Tanis, P.C.

(57) **CLAIM**

The ornamental design of the biscuit deck fastener, as shown and described.

DESCRIPTION

FIG. 1 is a top view of the biscuit deck fastener showing our new design;

FIG. 2 is a bottom view thereof;

FIG. 3 is a front view thereof;

FIG. 4 is a side view thereof;

FIG. 5 is a section view thereof taken at 5—5 in FIG. 1;

FIG. 6 is a front perspective view thereof; and,

FIG. 7 is a bottom perspective view thereof.

1 Claim, 2 Drawing Sheets

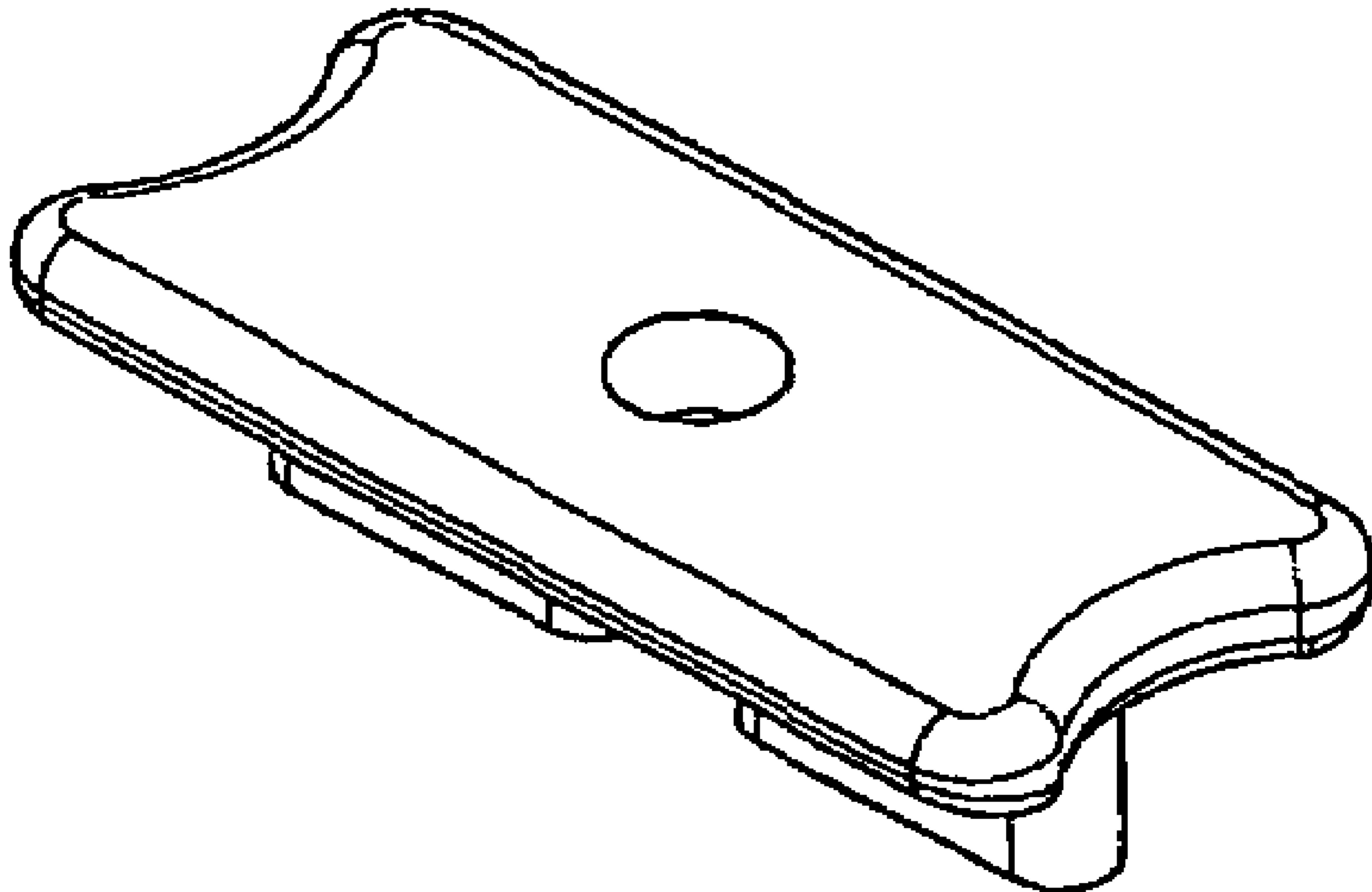

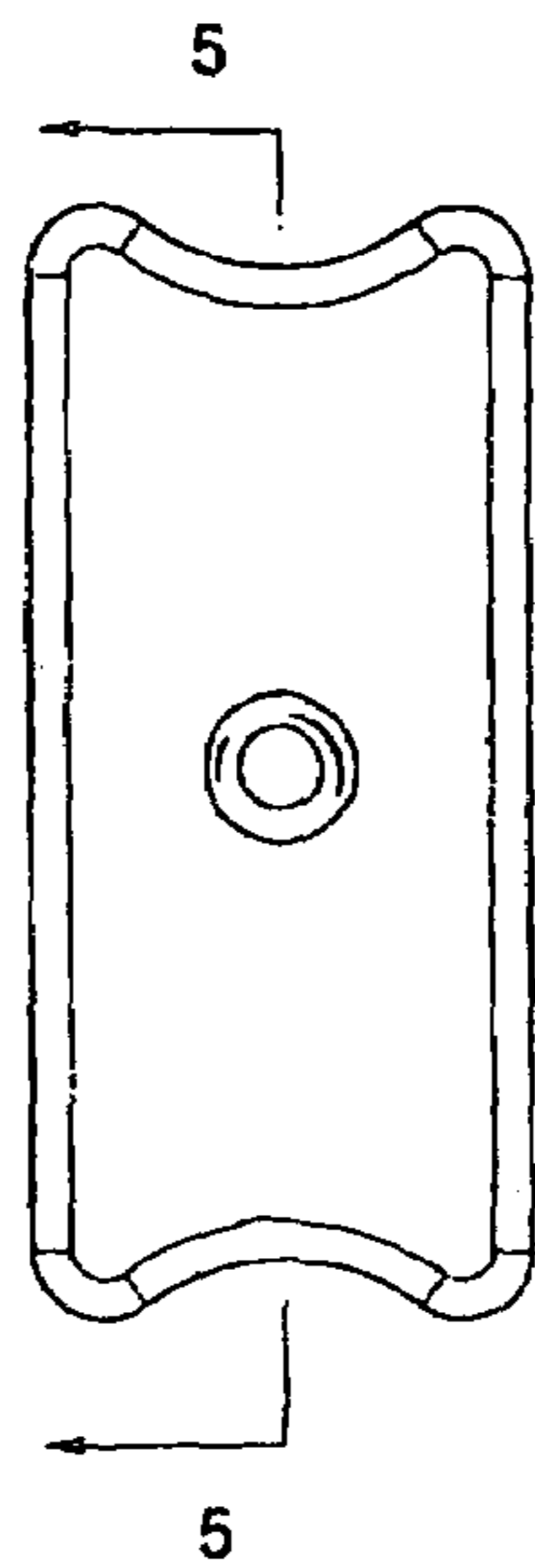

FIG 1

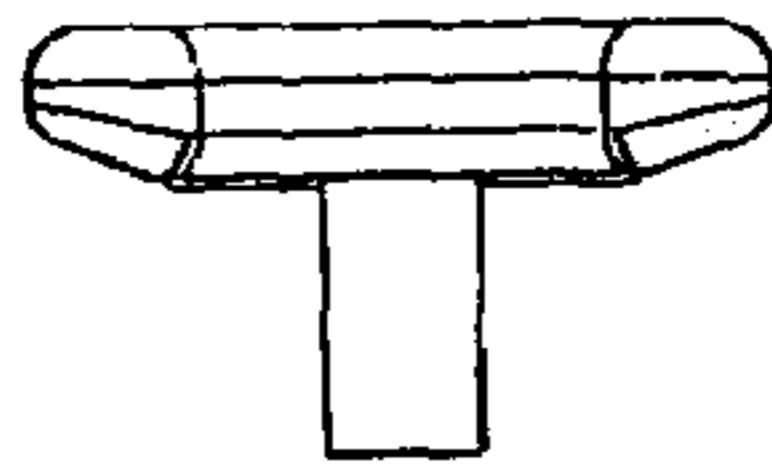

FIG 4

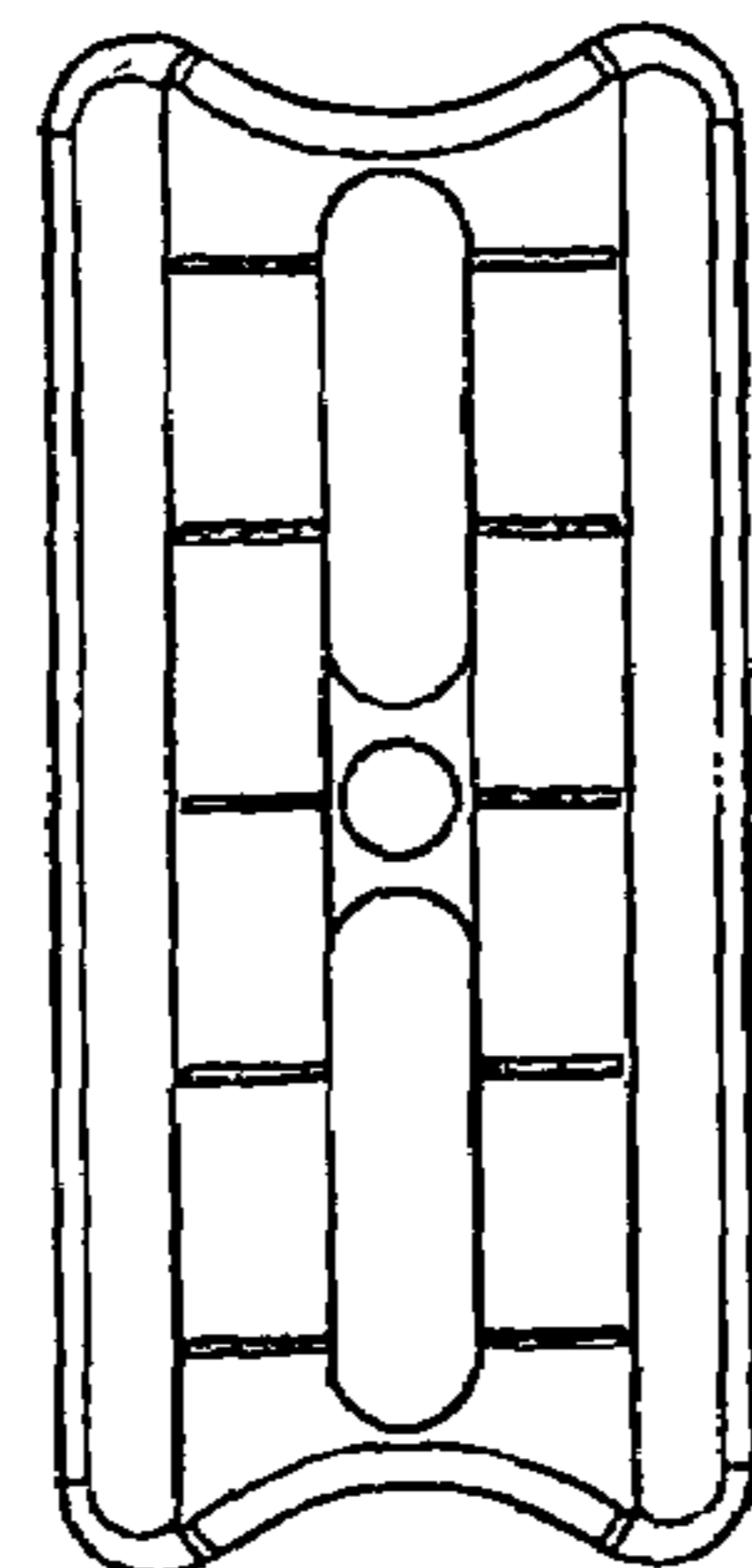

FIG 2

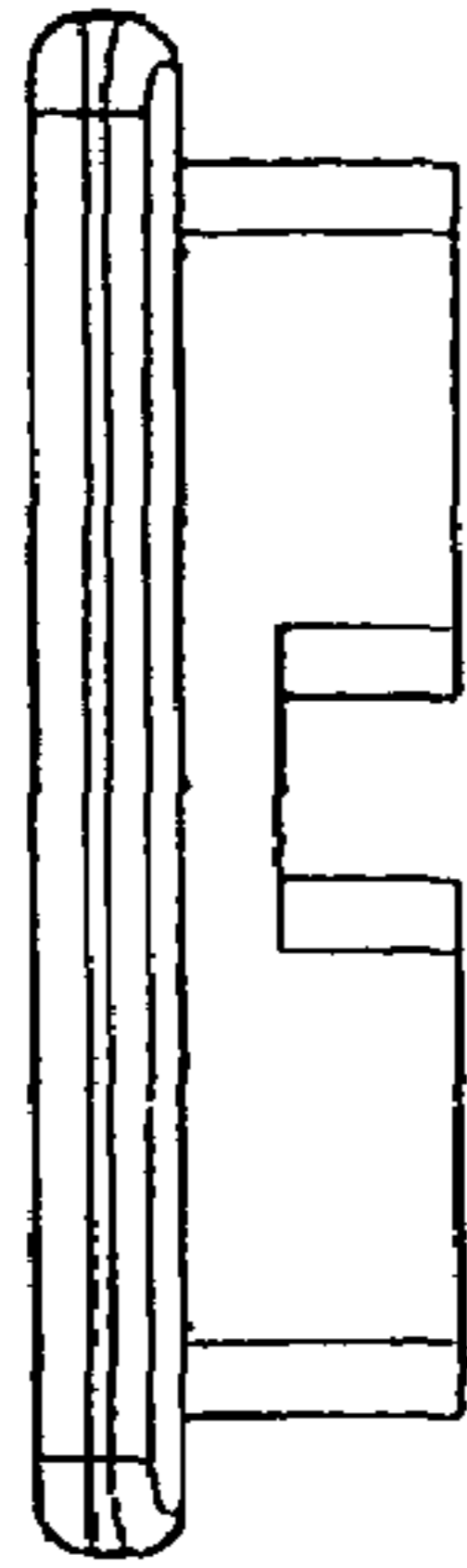

FIG 3

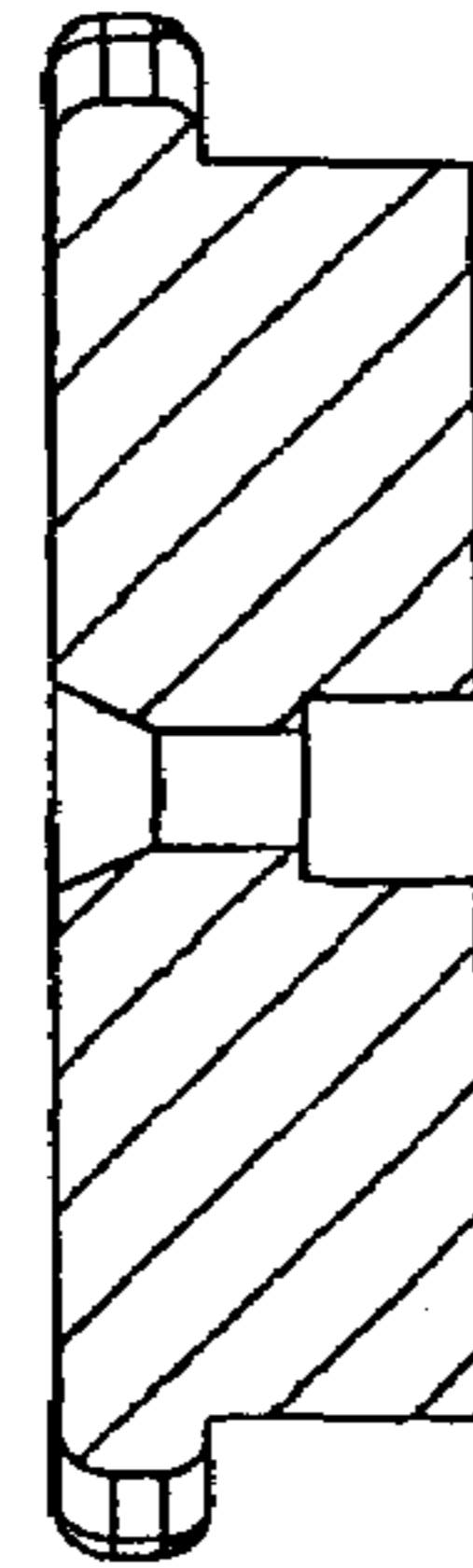

FIG 5

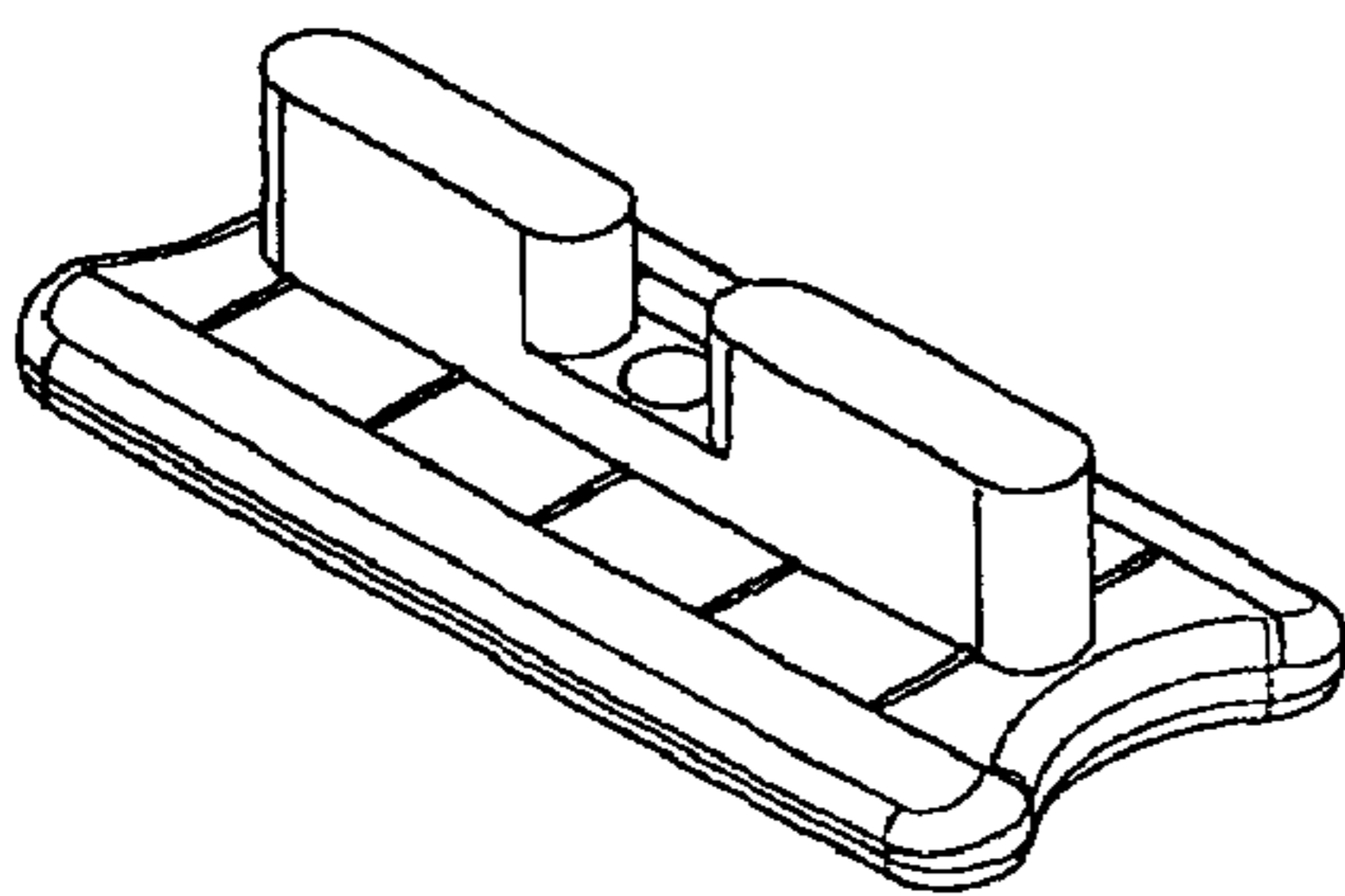

FIG 7

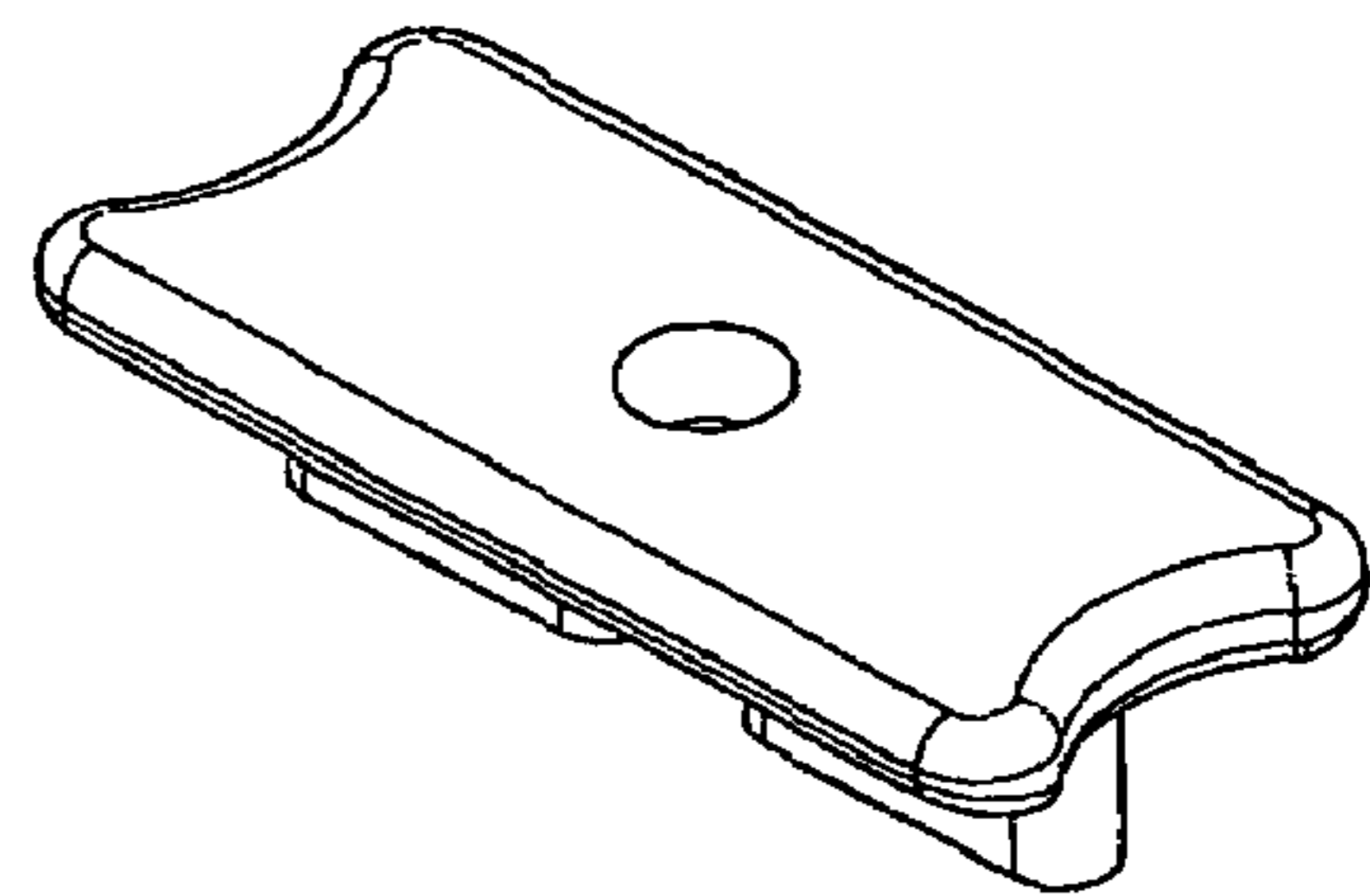

FIG 6