



US00D604580S

(12) **United States Design Patent**
Robinson et al.

(10) **Patent No.:** **US D604,580 S**

(45) **Date of Patent:** **** Nov. 24, 2009**

(54) **PLIERS**

(75) Inventors: **Glenn Robinson**, Coral Springs, FL
(US); **Michael Garcia**, Oakland Park,
FL (US)

(73) Assignee: **IBT Holdings, Inc**, Deerfield Beach, FL
(US)

(**) Term: **14 Years**

(21) Appl. No.: **29/301,636**

(22) Filed: **Mar. 11, 2008**

(51) **LOC (9) Cl.** **08-05**

(52) **U.S. Cl.** **D8/52**

(58) **Field of Classification Search** D8/4,
D8/14, 51, 52, 54-56, 58, 105, 107, 75-81;
7/125-137, 143-147; 81/300, 342, 348,
81/355-362, 364-366, 385-404, 407-418,
81/424.5, 426, 426.5, 427, 427.5

See application file for complete search history.

(56) **References Cited**

U.S. PATENT DOCUMENTS

D46,681 S *	11/1914	Kraeuter	D8/58
D57,252 S *	3/1921	Myers	D8/58
D59,774 S *	11/1921	Rice	D8/52
1,674,485 A *	6/1928	Smith	81/426
D92,822 S *	7/1934	Morse	D8/58
D177,537 S *	4/1956	Schinske	D8/58
2,774,268 A *	12/1956	Kagan	29/270
D225,387 S *	12/1972	Krock	D7/649
D252,611 S *	8/1979	Breger	D8/107
D299,108 S *	12/1988	Brdnik	D8/107
5,084,935 A *	2/1992	Kalthoff	7/132

D330,495 S *	10/1992	Cripe	D8/52
5,251,353 A *	10/1993	Lin	7/128
D403,223 S *	12/1998	Jacoff	D8/80
D406,520 S *	3/1999	Bunzel et al.	D8/107
D407,000 S *	3/1999	Jacoff	D8/80
D448,265 S *	9/2001	Chen	D8/80
D483,633 S *	12/2003	Jansson et al.	D8/52
D483,634 S *	12/2003	Jansson et al.	D8/52
D486,047 S *	2/2004	Jansson et al.	D8/52
6,862,959 B2 *	3/2005	Lin Wu	81/300
D507,467 S *	7/2005	Eidson	D8/52
D515,387 S *	2/2006	Hung	D8/80
7,021,177 B2 *	4/2006	Lovemark et al.	81/417
7,114,208 B1 *	10/2006	Borst	7/108

* cited by examiner

Primary Examiner—Cathron C Brooks

Assistant Examiner—Deanna Fluegeman

(74) *Attorney, Agent, or Firm*—Dan M. De La Rose

(57) **CLAIM**

The ornamental design for a pliers, as shown and described.

DESCRIPTION

FIG. 1 is a front perspective view of the pliers of the present invention showing my new design;

FIG. 2 is a front side elevational view thereof;

FIG. 3 is a top plan view thereof;

FIG. 4 is a side elevational view thereof;

FIG. 5 is a back side elevational view thereof;

FIG. 6 is another side elevational view thereof;

FIG. 7 is a bottom plan view thereof; and,

FIG. 8 is a rear perspective view of the pliers.

1 Claim, 4 Drawing Sheets

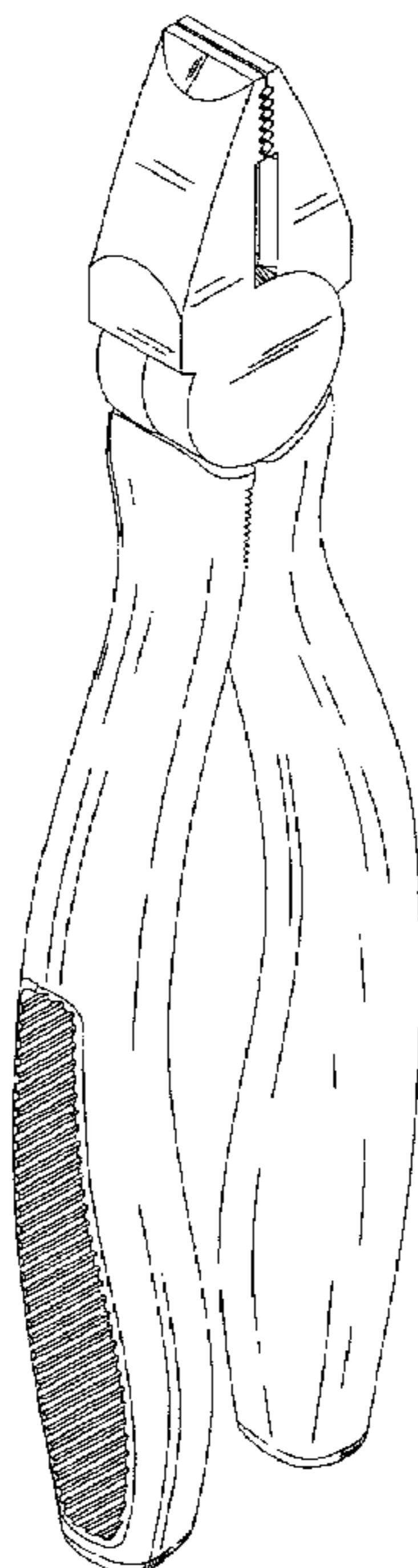

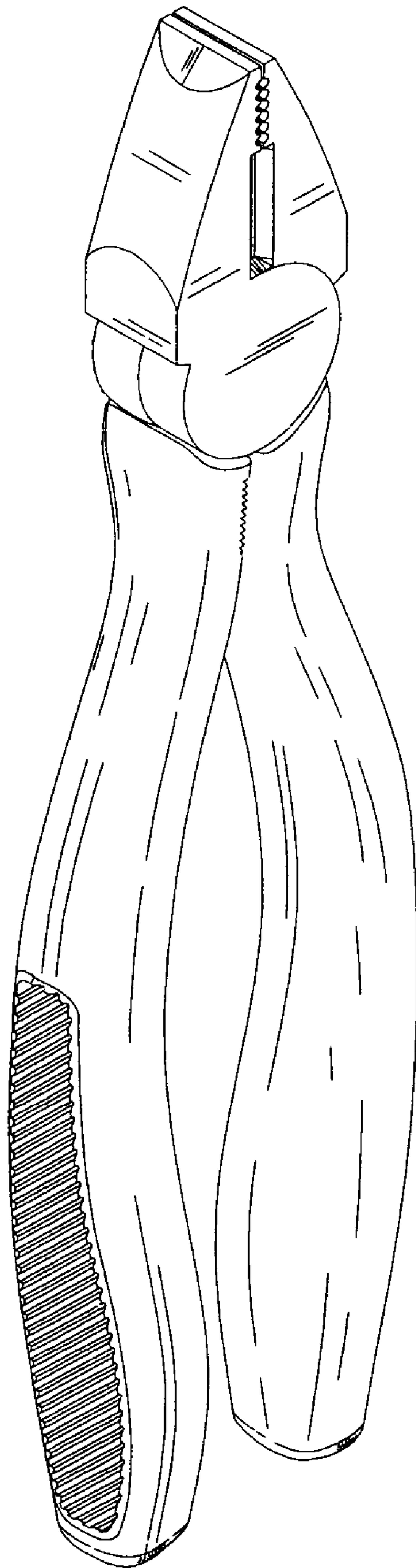

FIG. 1

FIG. 3

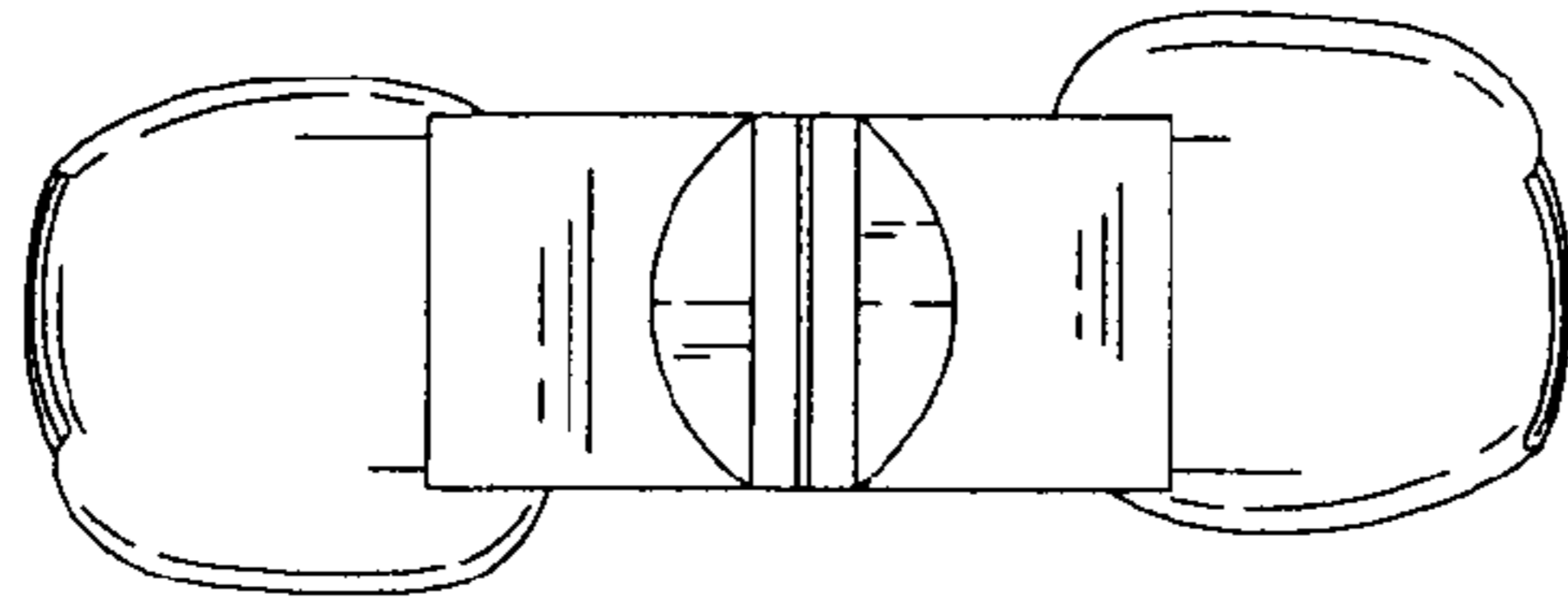

FIG. 2

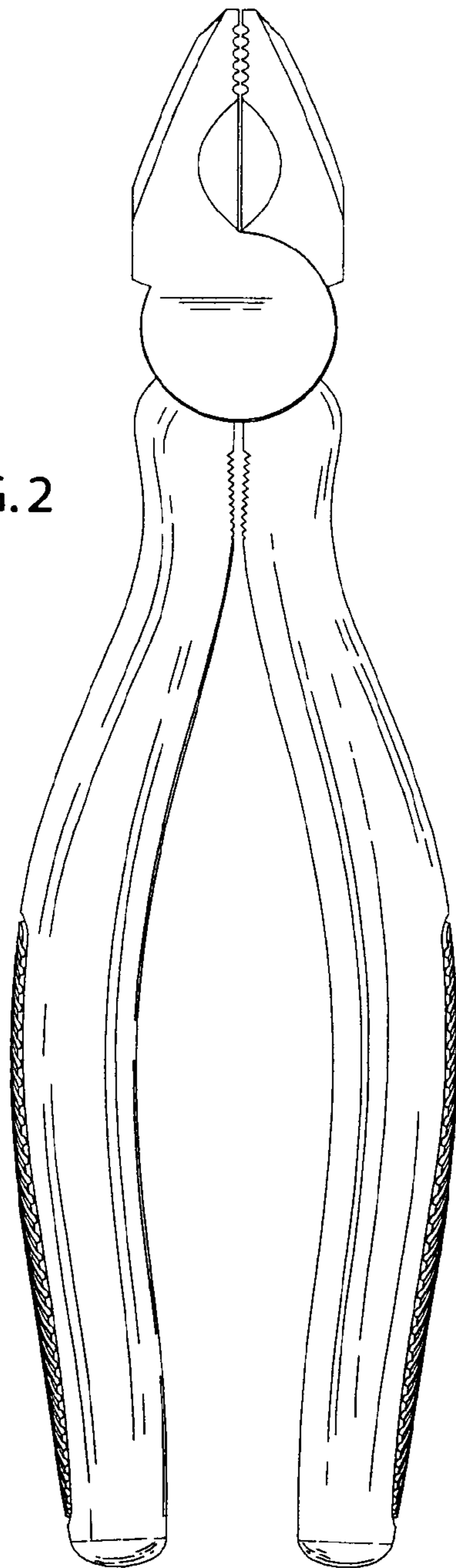
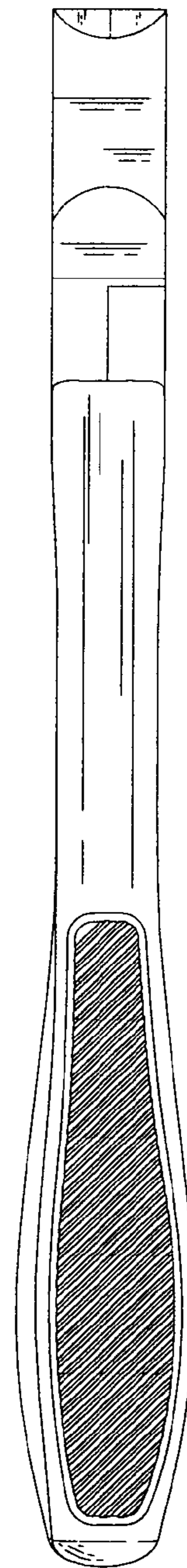

FIG. 4



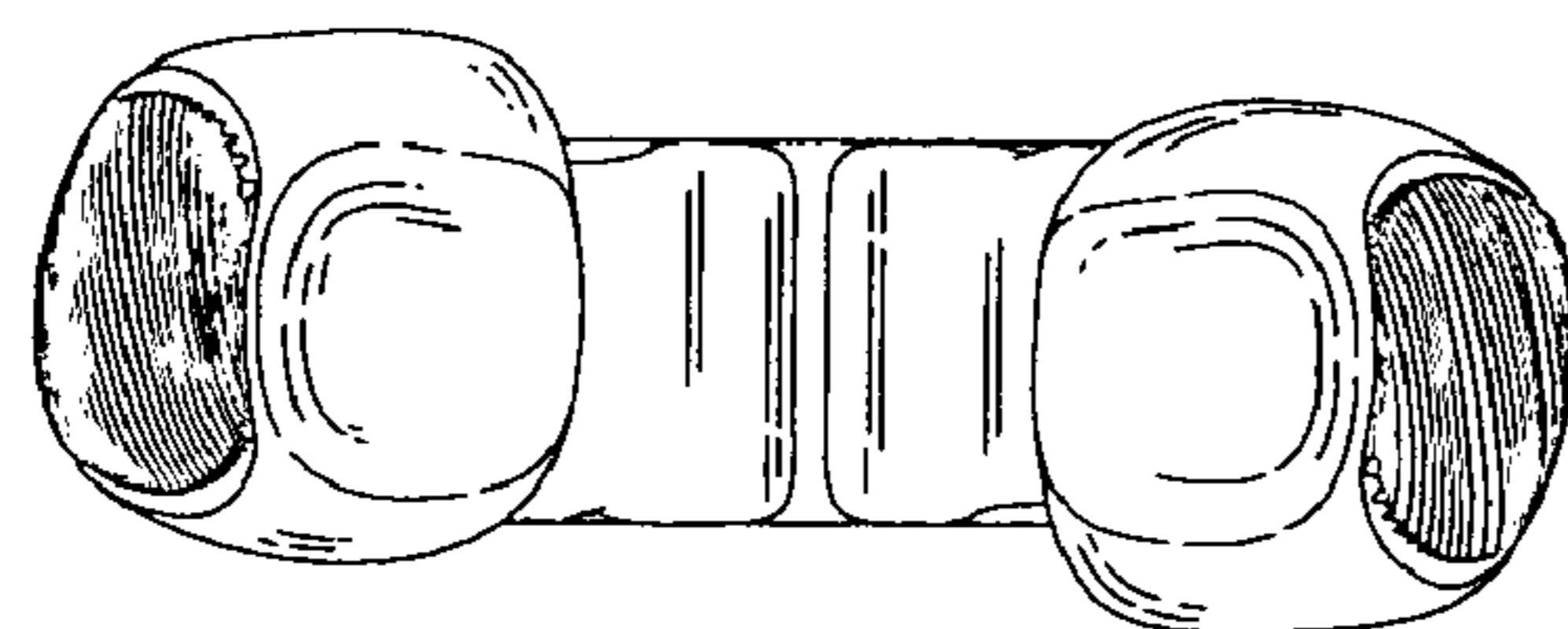
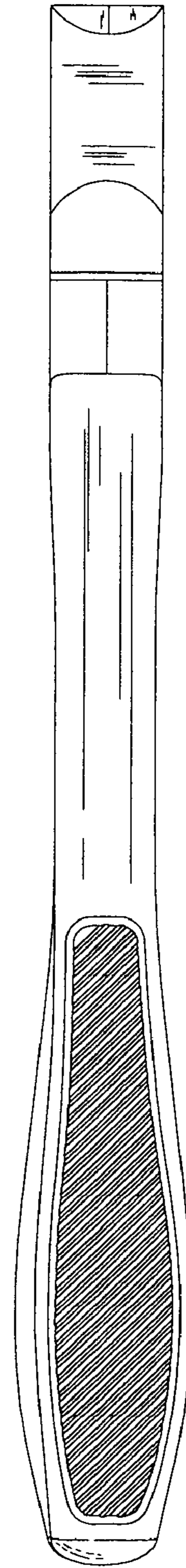
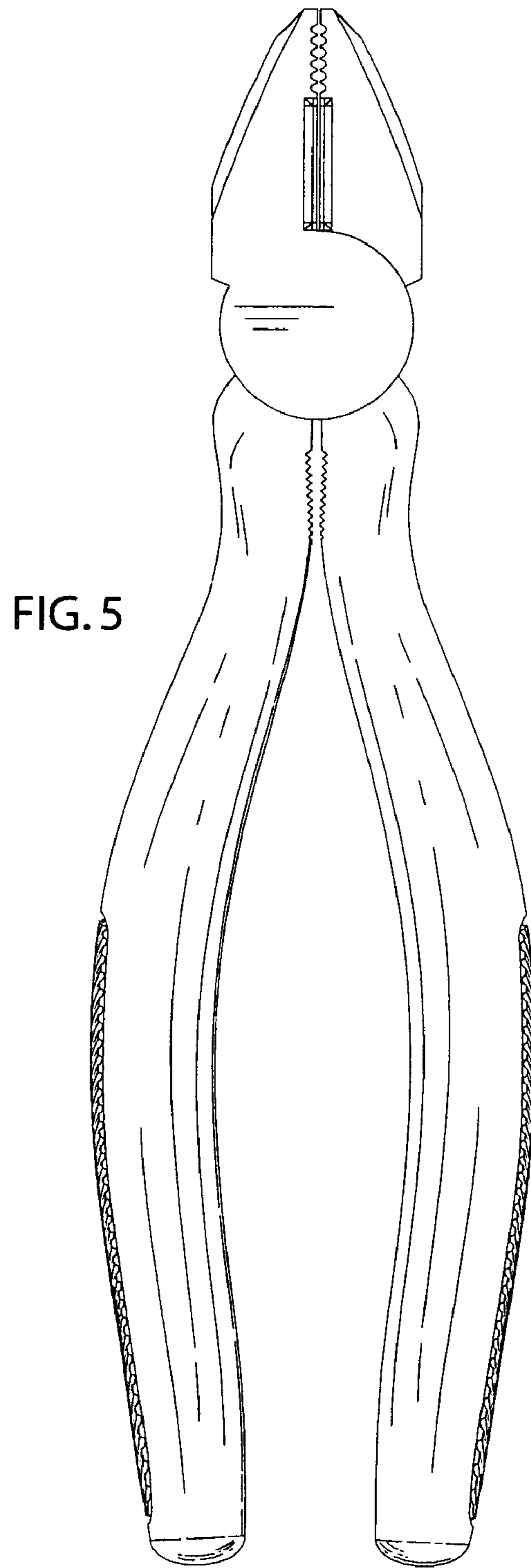

FIG. 7



FIG. 8