



US00D604537S

(12) **United States Design Patent**
Liss et al.

(10) **Patent No.:** **US D604,537 S**
(45) **Date of Patent:** **** Nov. 24, 2009**

(54) **PORTION OF AN EMBOSSED SHELF EDGE
IN SHELF UNIT**

(75) Inventors: **Mitchell Liss**, Northbrook, IL (US);
Tony Troyner, Shorewood, IL (US);
Thomas St. Germain, Bridgeview, IL
(US); **David Wojtowicz**, Orland Park, IL
(US)

(73) Assignee: **Edsal Manufacturing Co., Inc.**,
Chicago, IL (US)

(**) Term: **14 Years**

(21) Appl. No.: **29/296,538**

(22) Filed: **Oct. 23, 2007**

(51) **LOC (9) Cl.** **06-04**

(52) **U.S. Cl.** **D6/511**

(58) **Field of Classification Search** D6/511;
D8/380-382, 349, 354; D25/119-125; 403/402;
248/281.1; 211/88, 90, 126, 134-135, 153;
D5/53, 58, 59, 60

See application file for complete search history.

(56) **References Cited**

U.S. PATENT DOCUMENTS

D95,158	S	*	4/1935	Surerus	D25/158
3,548,505	A	*	12/1970	Candilo	33/527
3,682,738	A	*	8/1972	Smith	156/283
D288,966	S	*	3/1987	Gordon et al.	D25/119
D357,407	S	*	4/1995	Pate	D8/381
D456,533	S	*	4/2002	Moller, Jr.	D25/163
D474,676	S	*	5/2003	Bainbridge	D8/354
D490,260	S	*	5/2004	Bowen	D6/511
D494,045	S	*	8/2004	Van Essen et al.	D8/366
D500,059	S	*	12/2004	Schmidt et al.	D15/91
D510,832	S	*	10/2005	Schmidt et al.	D6/561
D513,809	S	*	1/2006	Zimmerle et al.	D25/138
D514,854	S	*	2/2006	Schmidt et al.	D6/510

D527,212	S	*	8/2006	Schmidt et al.	D6/510
D546,597	S	*	7/2007	Schmidt et al.	D6/510
D547,642	S	*	7/2007	Urmson et al.	D8/382
D551,883	S	*	10/2007	Gaska et al.	D6/510
7,281,359	B2	*	10/2007	Marshall	52/712
D569,143	S	*	5/2008	Liss et al.	D6/511

* cited by examiner

Primary Examiner—Elizabeth A Albert
Assistant Examiner—Kelley A Donnelly

(74) *Attorney, Agent, or Firm*—Wood, Herron & Evans, LLP

(57) **CLAIM**

The ornamental design for a portion of an embossed shelf edge in shelf unit, as shown and described.

DESCRIPTION

FIG. 1 is an isometric view of the design in a shelving unit with the unit shown in broken lines for environment;

FIG. 2 is an enlarged perspective view of a portion of the shelf edge of FIG. 1;

FIG. 3 is a front view of the design of FIG. 1;

FIG. 4 is a right side view of the design of FIG. 1;

FIG. 5 is a rear view of the design of FIG. 1;

FIG. 6 is a left side view of the design of FIG. 1;

FIG. 7 is a top view of the design of FIG. 1; and,

FIG. 8 is a bottom view of the design of FIG. 6.

The break lines on the edges of the embossed areas in FIGS. 1, 2, 3, 5, 7 and 8 are not part of the claimed design and represent that no particular length is claimed.

Diagonal lines on the edges of pieces in FIGS. 2, 4, and 6 and the break lines on the edges of pieces in FIGS. 2, 3, 5, 7, and 8 are used to indicate cutaway portions, are not shading or design features, and form no part of the claimed design.

1 Claim, 5 Drawing Sheets

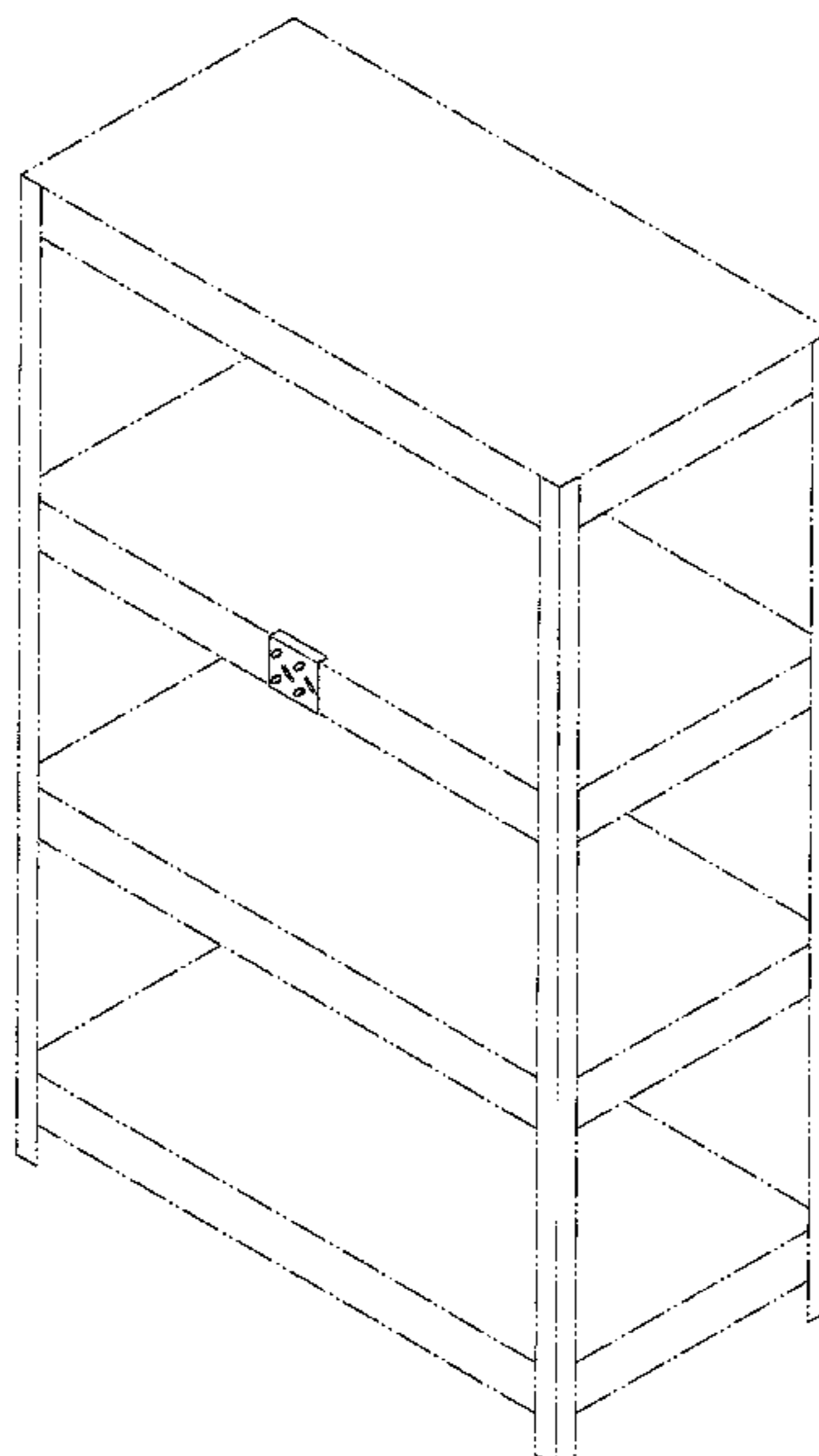

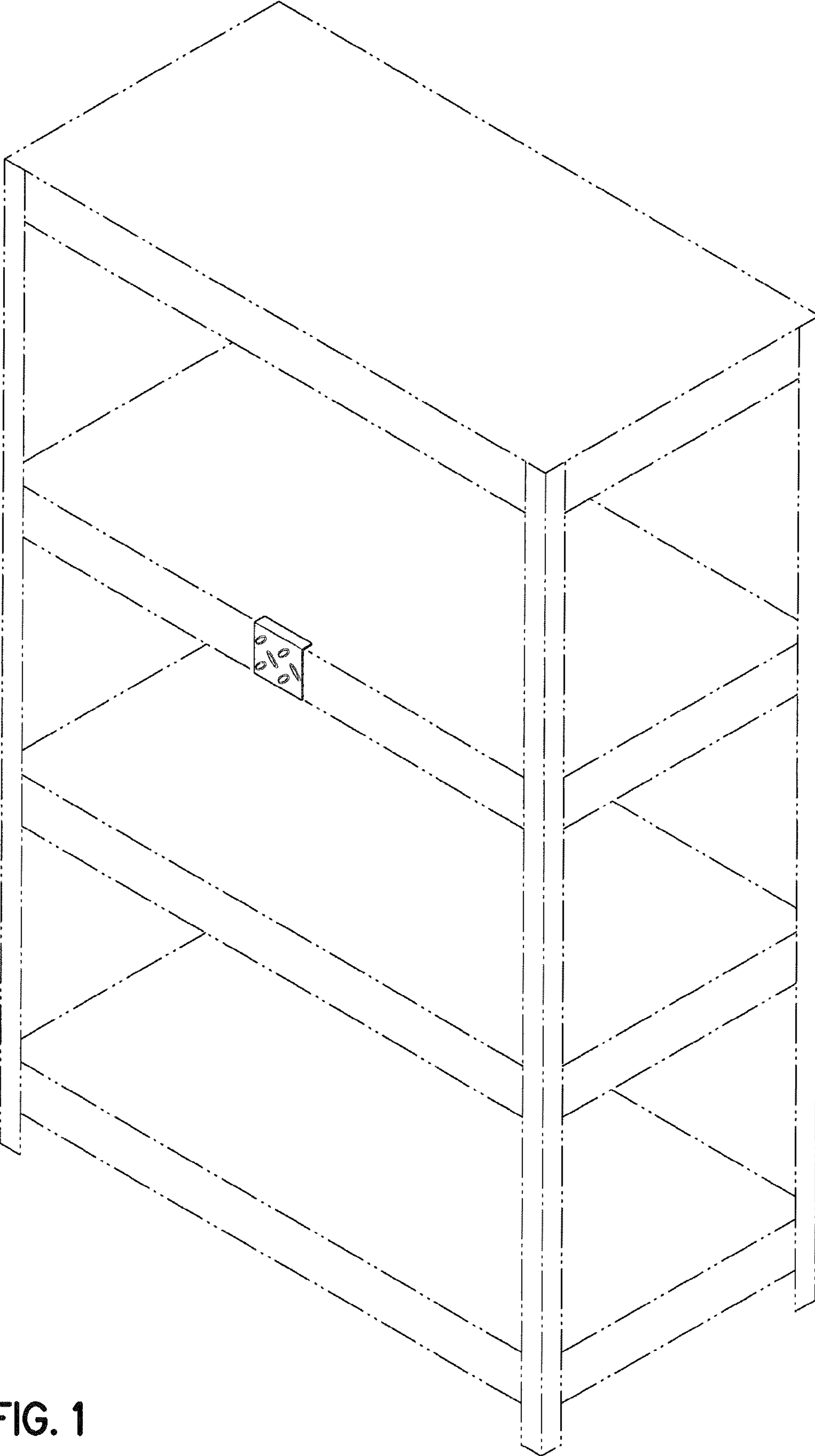

FIG. 1

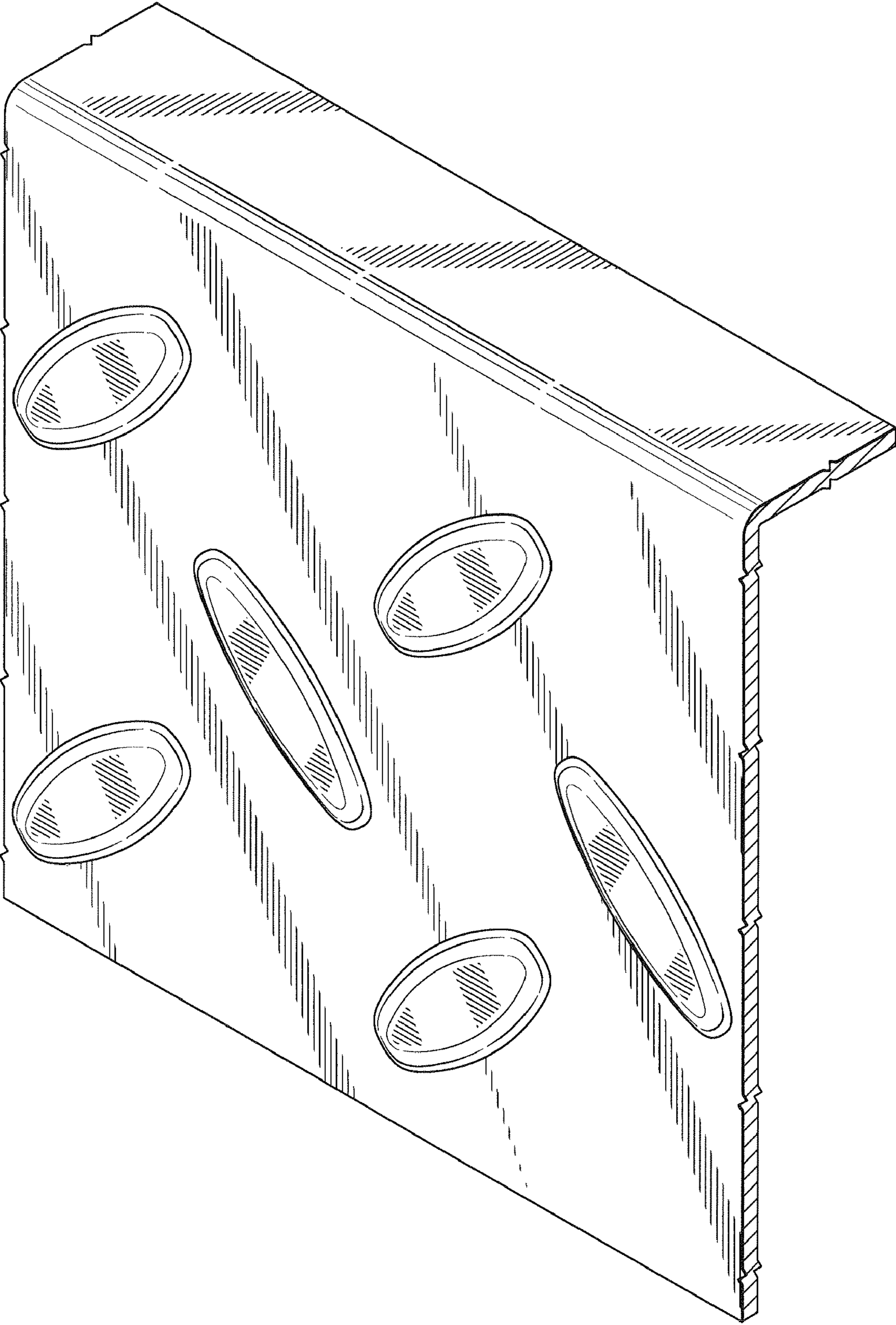

FIG. 2

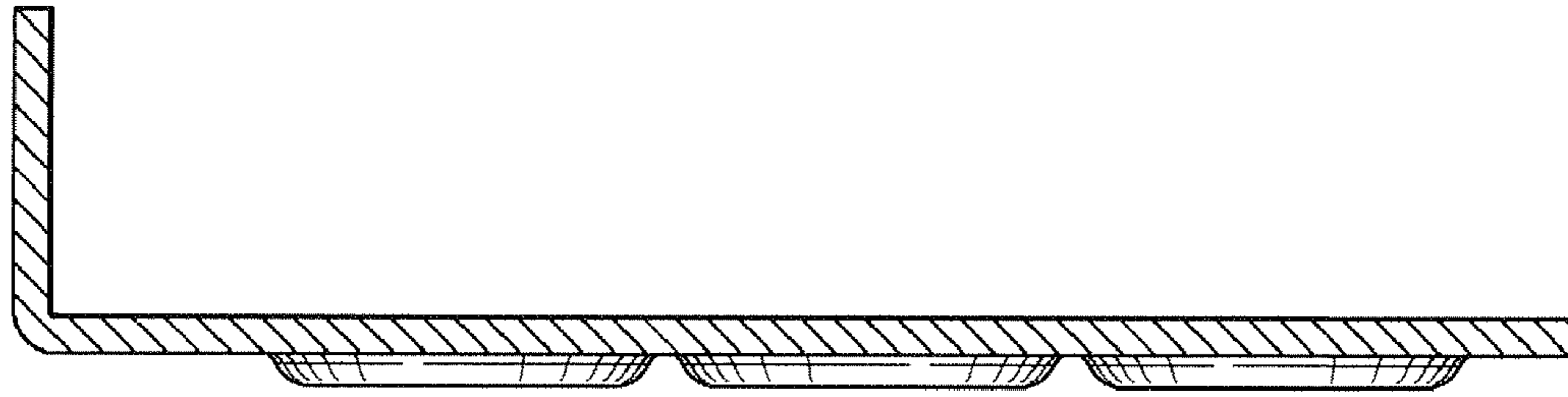

FIG. 4

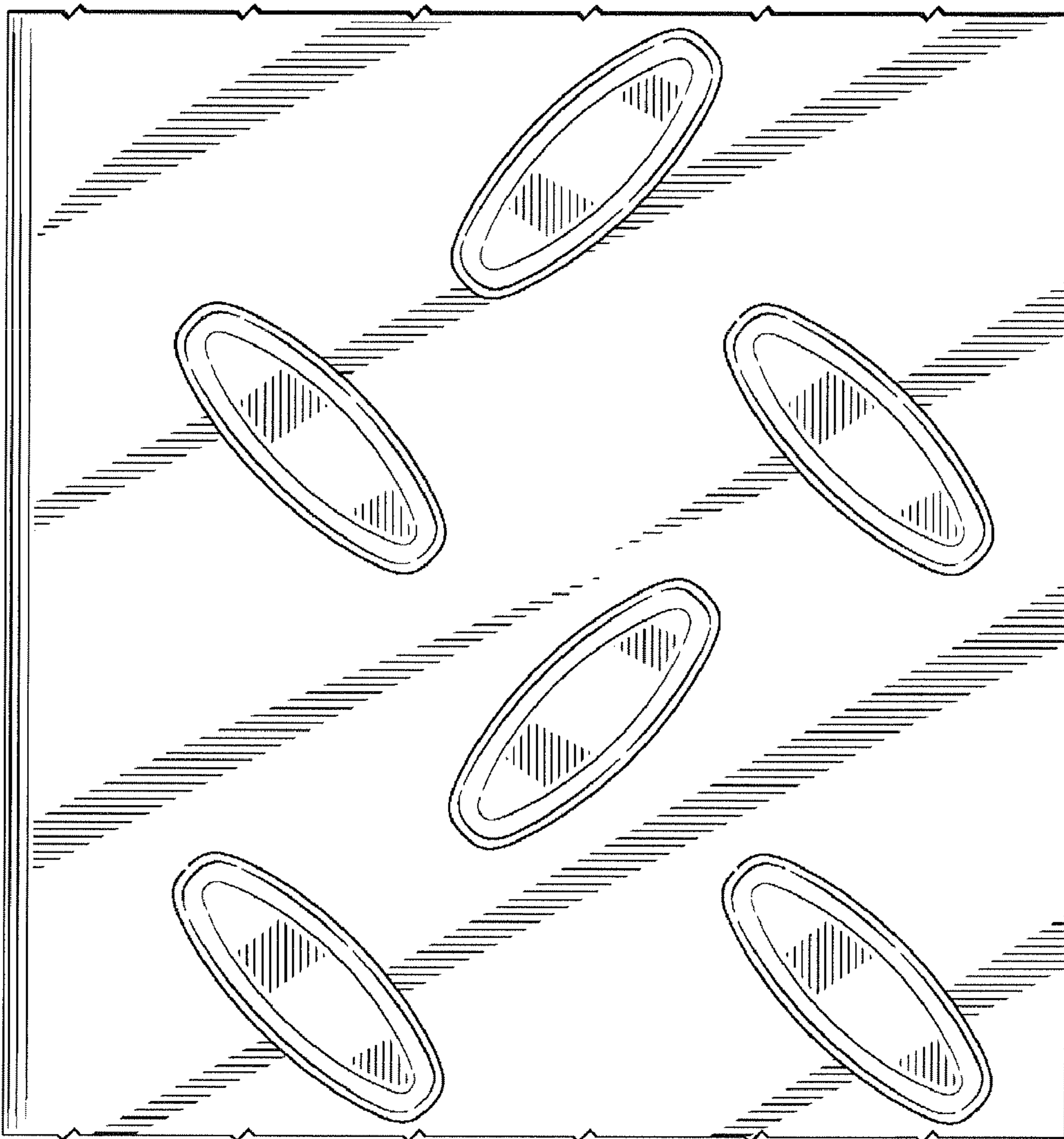

FIG. 3

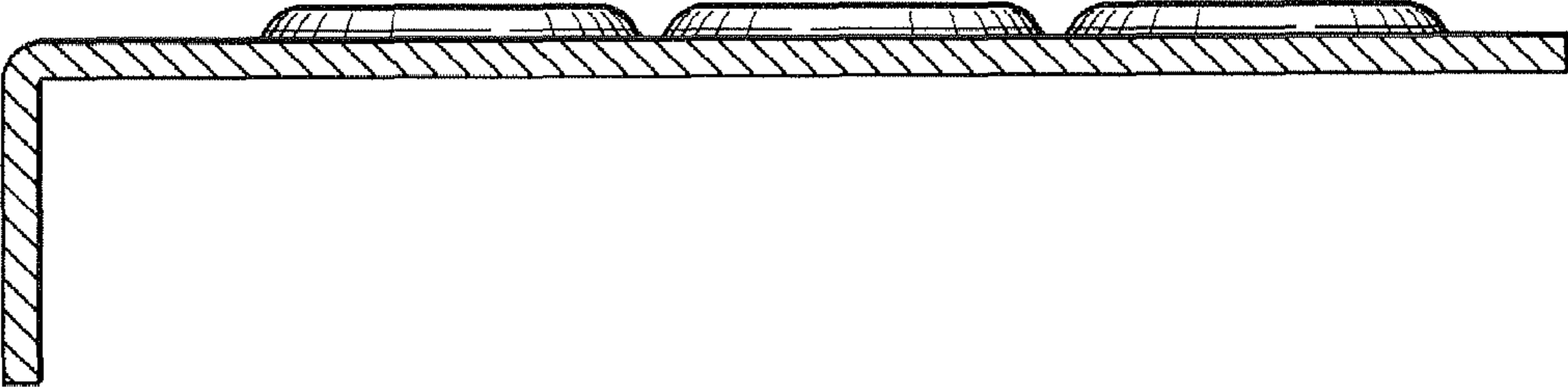

FIG. 6

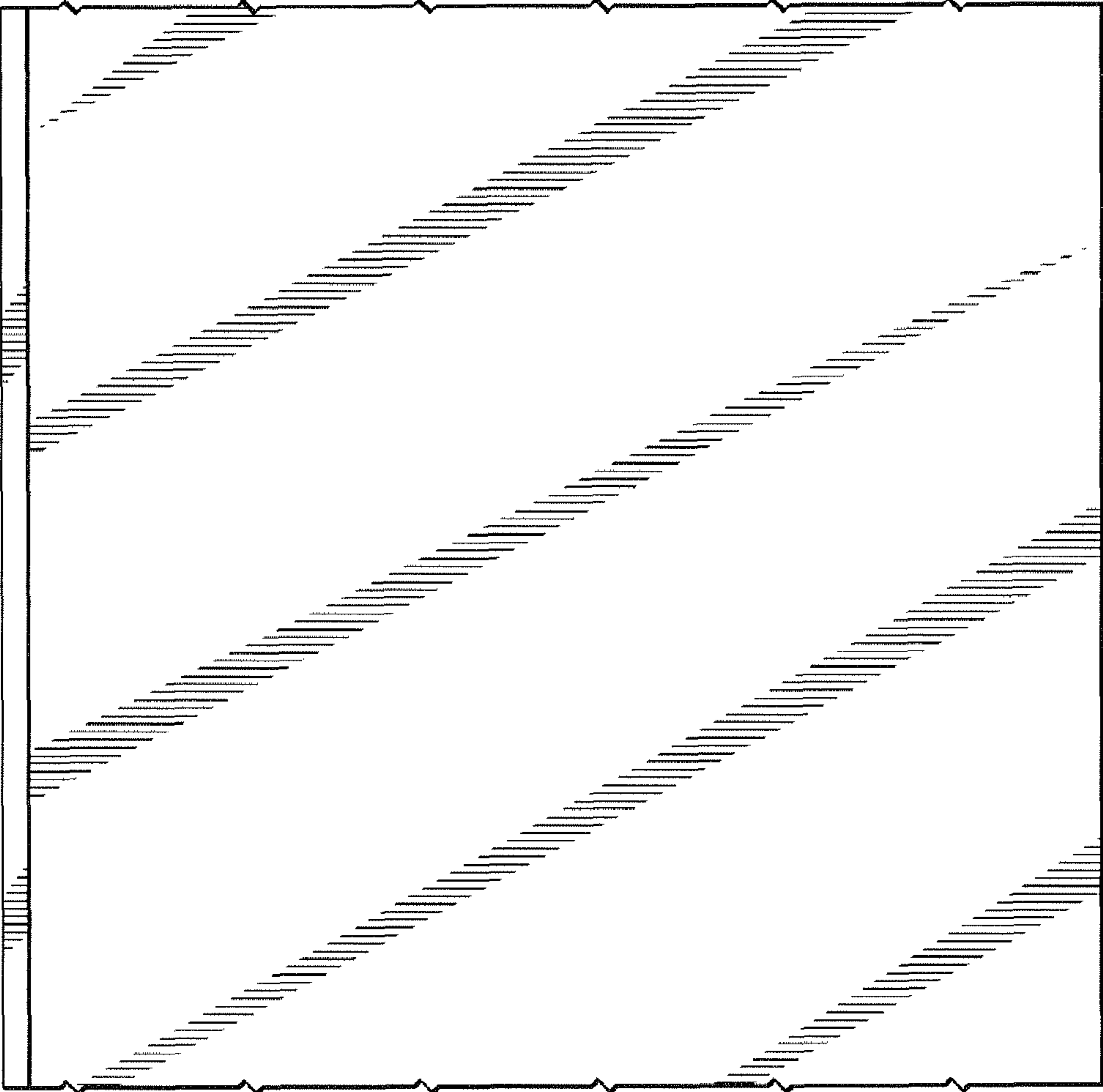

FIG. 5

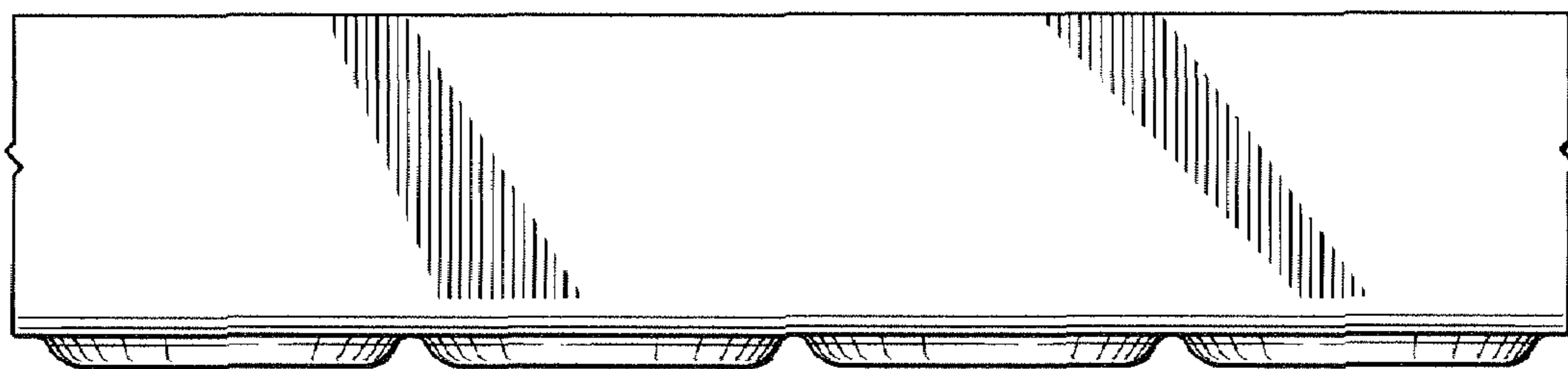

FIG. 7

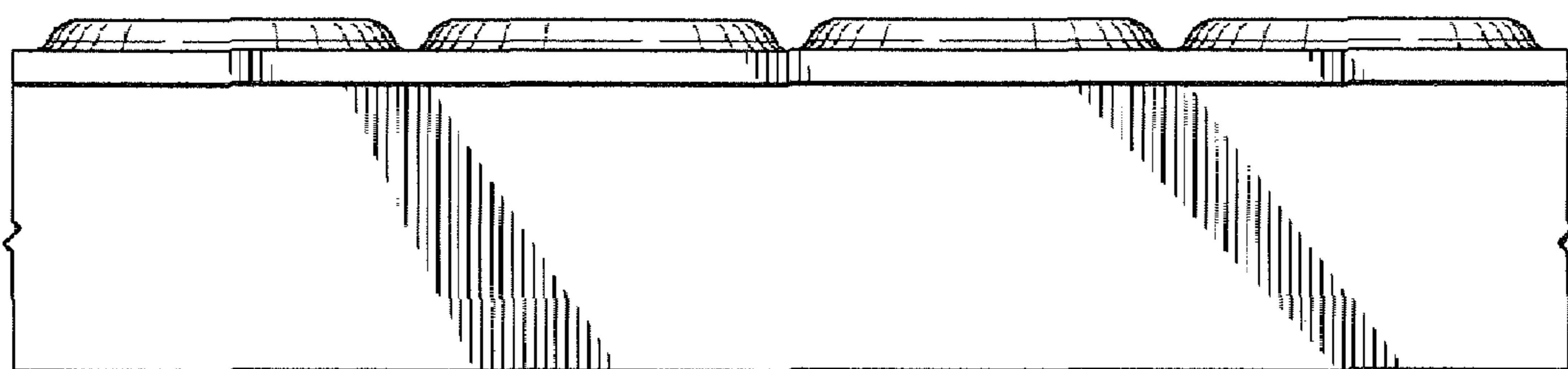

FIG. 8