



US00D604491S

(12) **United States Design Patent**
Issler

(10) **Patent No.:** **US D604,491 S**

(45) **Date of Patent:** **** Nov. 24, 2009**

(54) **UPPER FOR A SHOE**

(75) Inventor: **David C. Issler**, Andover, MA (US)

(73) Assignee: **Columbia Insurance Company**,
Omaha, NE (US)

(**) Term: **14 Years**

(21) Appl. No.: **29/332,752**

(22) Filed: **Feb. 25, 2009**

(51) **LOC (9) Cl.** **02-99**

(52) **U.S. Cl.** **D2/971; D2/926; D2/933**

(58) **Field of Classification Search** D2/896,
D2/916-918, 925-942, 946, 969, 971; 36/1,
36/83, 8.3, 45-58

See application file for complete search history.

(56) **References Cited**

U.S. PATENT DOCUMENTS

D85,018 S *	9/1931	Troy	D2/930
D92,149 S *	5/1934	Miller	D2/933
D92,238 S *	5/1934	Elkin	D2/933
D93,513 S *	10/1934	Phifer	D2/933
D99,484 S *	4/1936	Troy	D2/933
D131,068 S *	1/1942	Julianelli	D2/932
D131,839 S *	3/1942	Elkin	D2/932
D168,077 S *	10/1952	Turiansky	D2/927
D547,538 S *	7/2007	Belley et al.	D2/969

D550,935 S *	9/2007	Issler	D2/916
D557,004 S *	12/2007	Guers-Neyrud	D2/971
D586,547 S *	2/2009	Houser et al.	D2/971
D586,985 S *	2/2009	Taestensen	D2/927
D589,244 S *	3/2009	Lawler	D2/971

* cited by examiner

Primary Examiner—Dominic Simone

(74) *Attorney, Agent, or Firm*—DeLio & Peterson, LLC;
David Chen

(57) **CLAIM**

The ornamental design for an upper for a shoe, as shown and described.

DESCRIPTION

FIG. 1 is a top perspective view of an upper for a shoe in accordance with my new design;

FIG. 2 is right view thereof;

FIG. 3 is a left side view thereof;

FIG. 4 is a top view thereof;

FIG. 5 is a front view thereof; and,

FIG. 6 is a rear view thereof.

The broken lines shown in all of the figures are for environmental purposes and form no part of the claim.

1 Claim, 6 Drawing Sheets

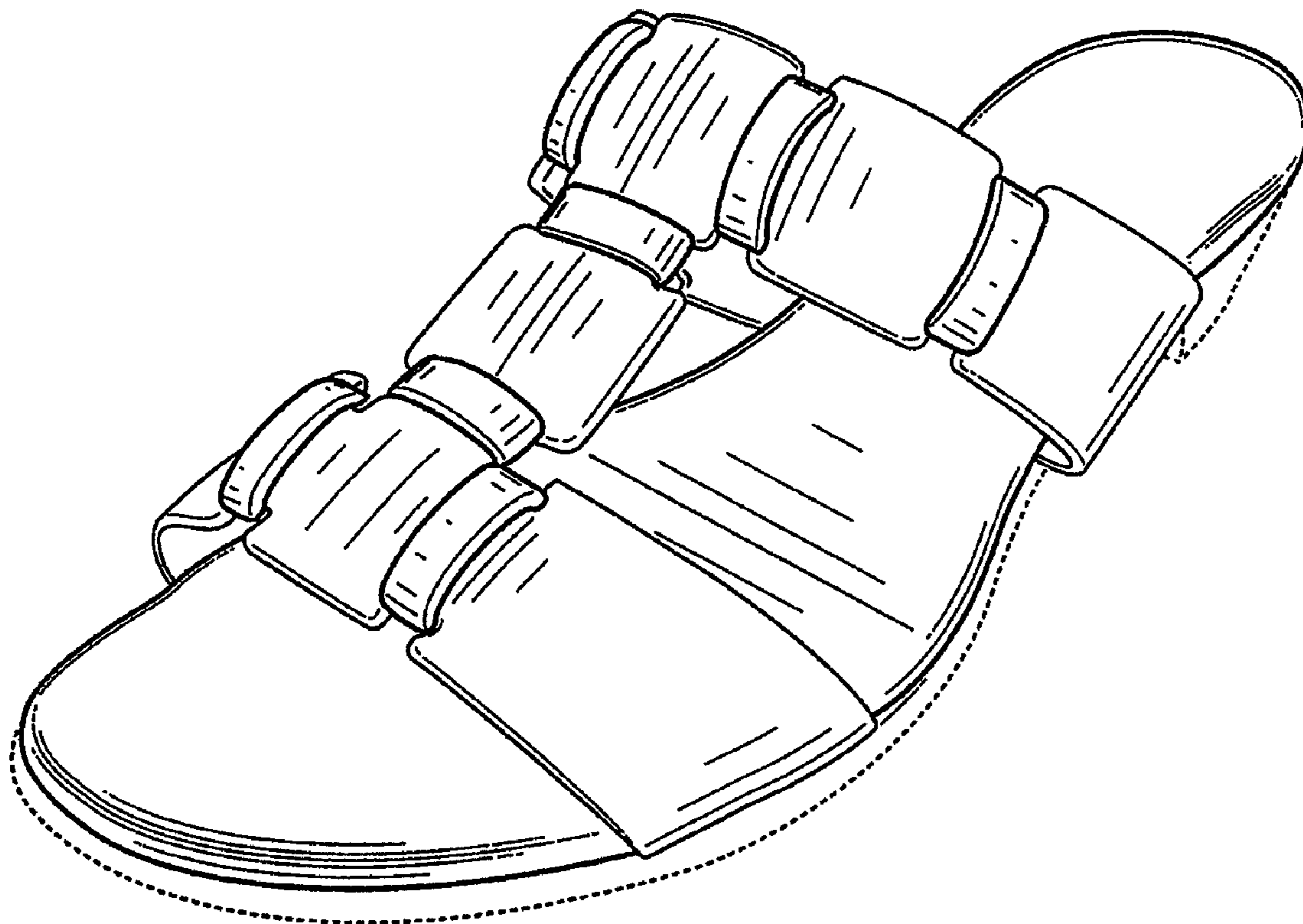

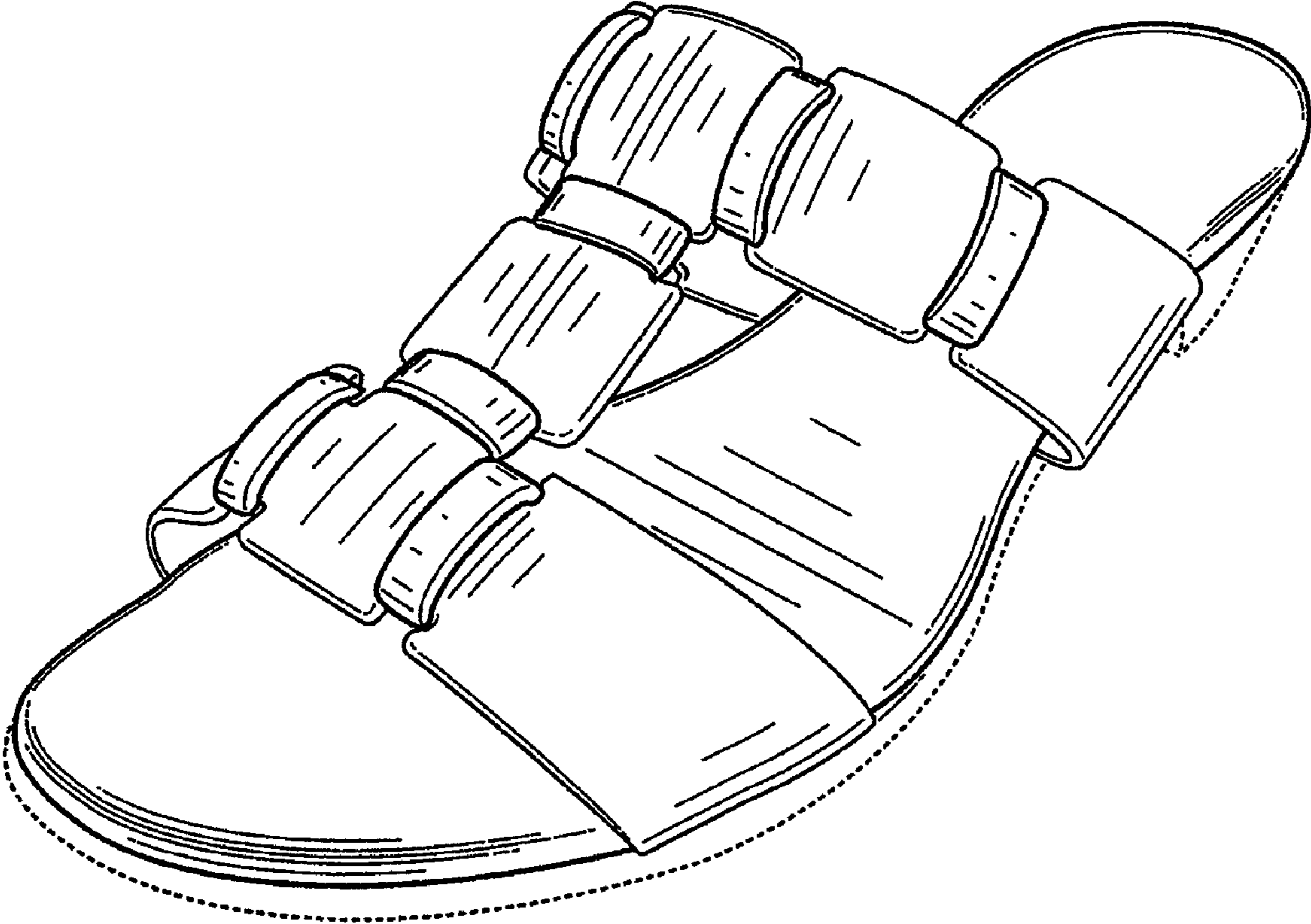

FIG. 1

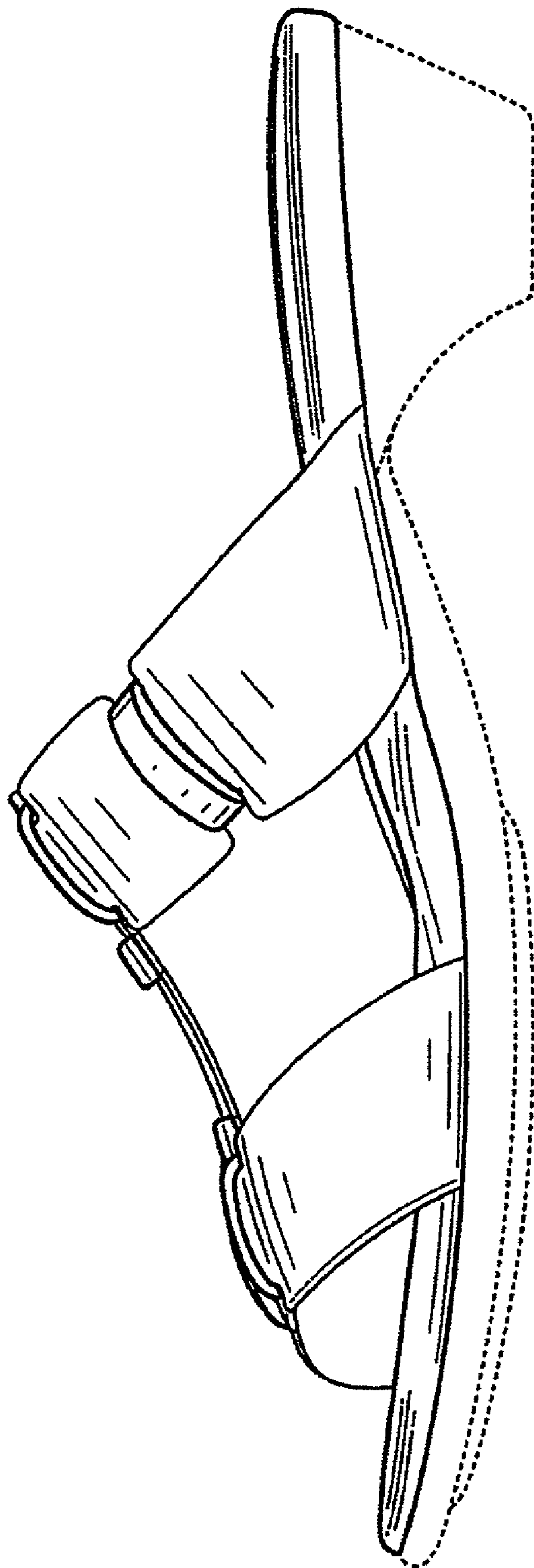

FIG. 2

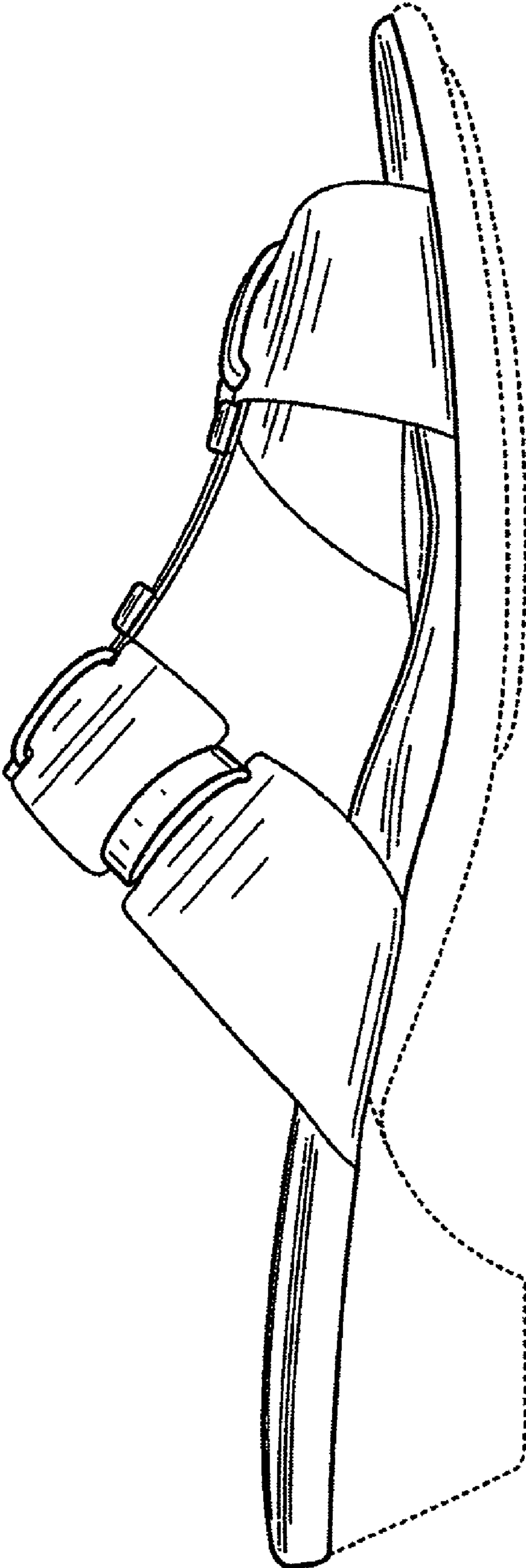

FIG. 3

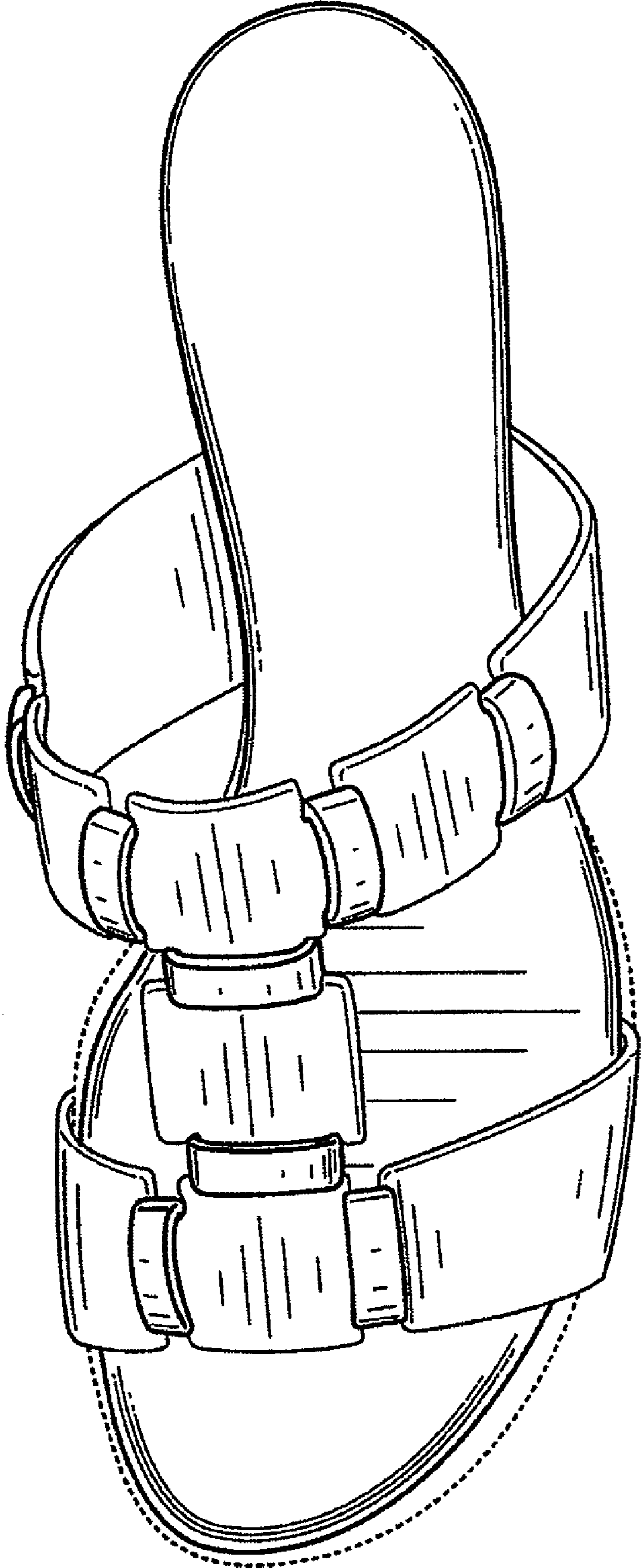

FIG. 4

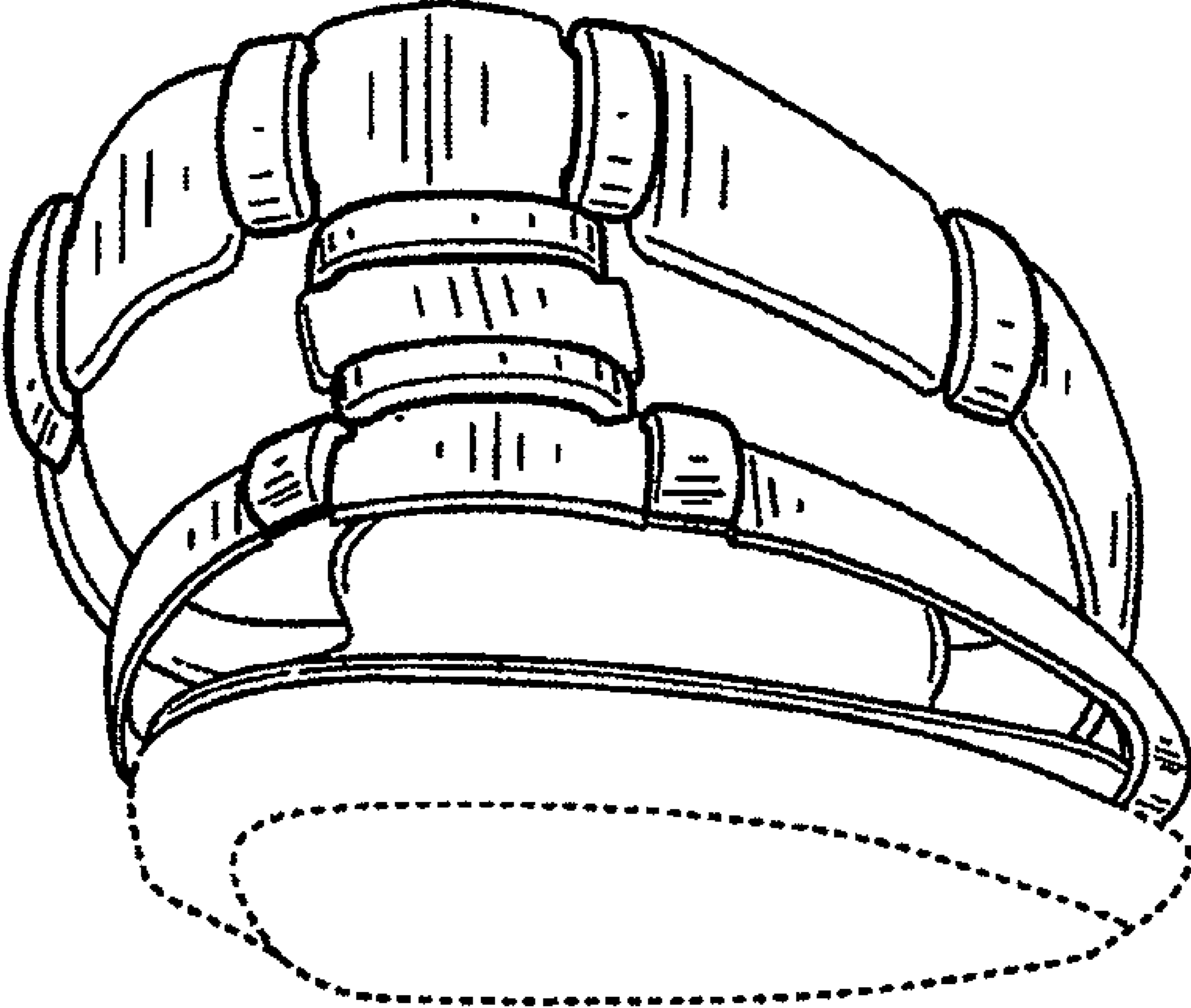

FIG. 5

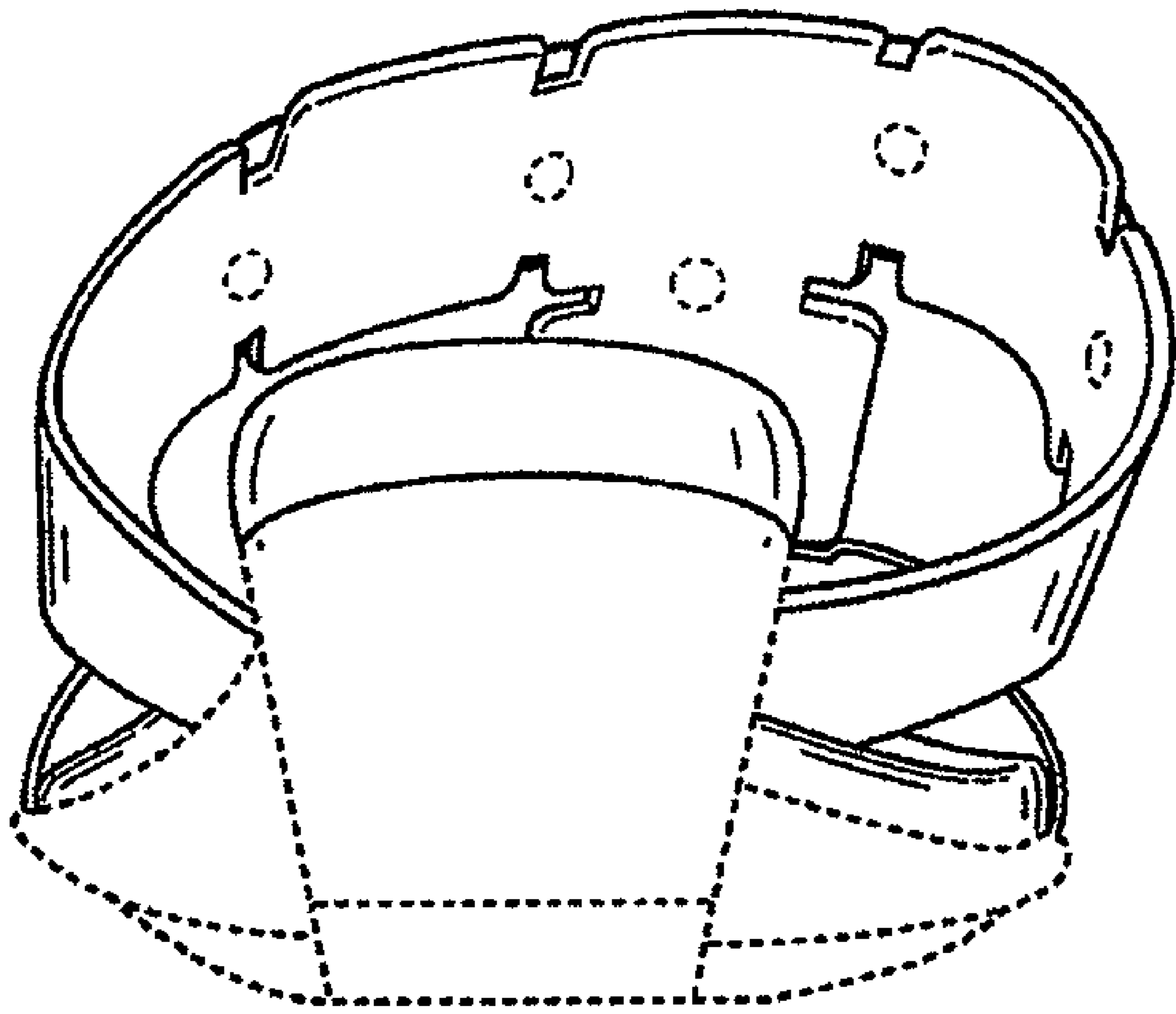

FIG. 6