



US00D604455S

(12) **United States Design Patent**  
**Chen et al.**

(10) **Patent No.:** **US D604,455 S**

(45) **Date of Patent:** **\*\* Nov. 17, 2009**

(54) **ELLIPTICAL LAMP HOUSING**

(75) Inventors: **Pin-Chun Chen**, Chung-Ho (TW);  
**Chih-Wei Hsu**, Chung-Ho (TW);  
**Po-Hsun Yu**, Chung-Ho (TW);  
**Chun-Chiang Huang**, Chung-Ho (TW)

(73) Assignee: **Edison Opto Corporation**, Taipei (TW)

(\*\*) Term: **14 Years**

(21) Appl. No.: **29/341,975**

(22) Filed: **Aug. 16, 2009**

(51) **LOC (9) Cl.** ..... **26-99**

(52) **U.S. Cl.** ..... **D26/142**

(58) **Field of Classification Search** ..... D26/85,  
D26/118, 128, 142, 72, 73, 113, 120, 122,  
D26/129, 130, 131, 138, 26, 61, 62, 74, 77,  
D26/88, 90, 103, 104, 121, 123, 124, 132,  
D26/134, 137; 362/147, 151, 644, 323, 347,  
362/351, 358, 362, 364, 404

See application file for complete search history.

(56) **References Cited**

U.S. PATENT DOCUMENTS

D355,502 S \* 2/1995 Liao ..... D26/67

6,375,338 B1 \* 4/2002 Cummings et al. .... 362/276  
D471,657 S \* 3/2003 Huang ..... D26/28  
D514,008 S \* 1/2006 Sassoon ..... D10/113  
D561,361 S \* 2/2008 Pan et al. .... D26/28

\* cited by examiner

*Primary Examiner*—Cathron C Brooks

*Assistant Examiner*—Kevin K Rudzinski

(74) *Attorney, Agent, or Firm*—Chun-Ming Shih

(57) **CLAIM**

The ornamental design for an elliptical lamp housing, as shown and described.

**DESCRIPTION**

FIG. 1 is a perspective view of an elliptical lamp housing showing my new design;

FIG. 2 is a front and rear view thereof;

FIG. 3 is a left side view thereof;

FIG. 4 is a right side view thereof;

FIG. 5 is a top view thereof;

FIG. 6 is a bottom view thereof; and,

FIG. 7 is a cross-sectional view thereof, taken along line 7—7 in FIG. 5.

**1 Claim, 6 Drawing Sheets**

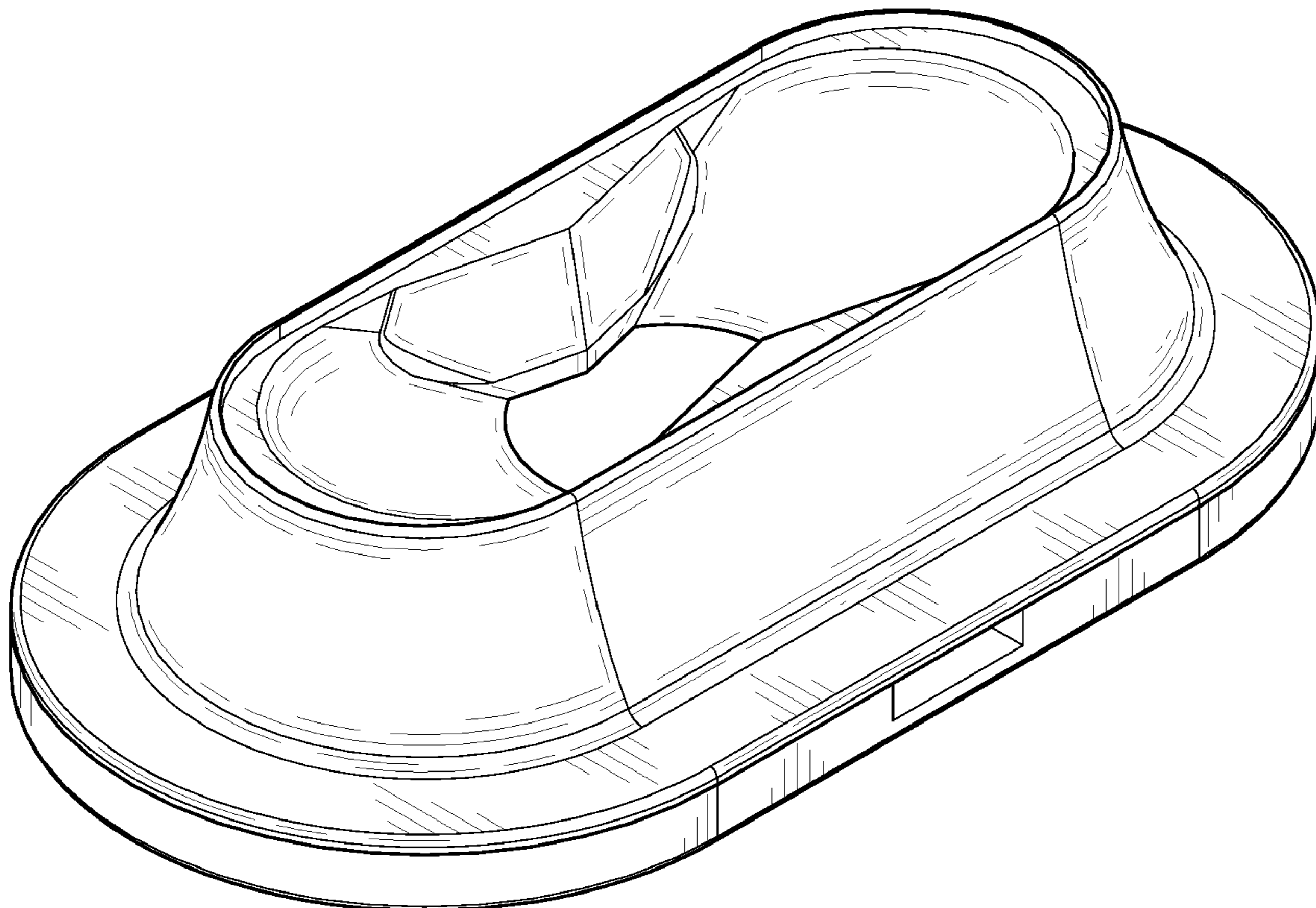

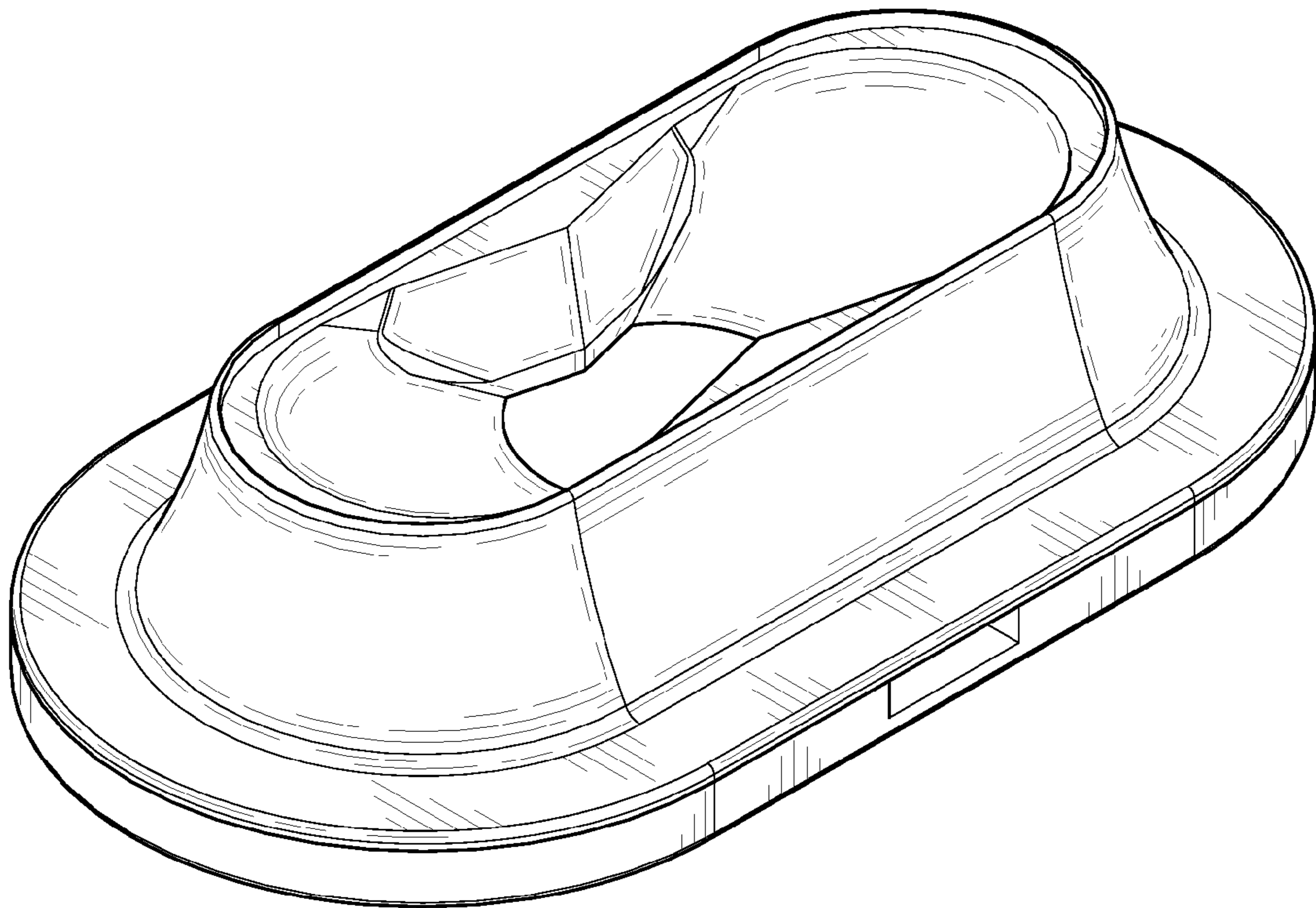

FIG.1

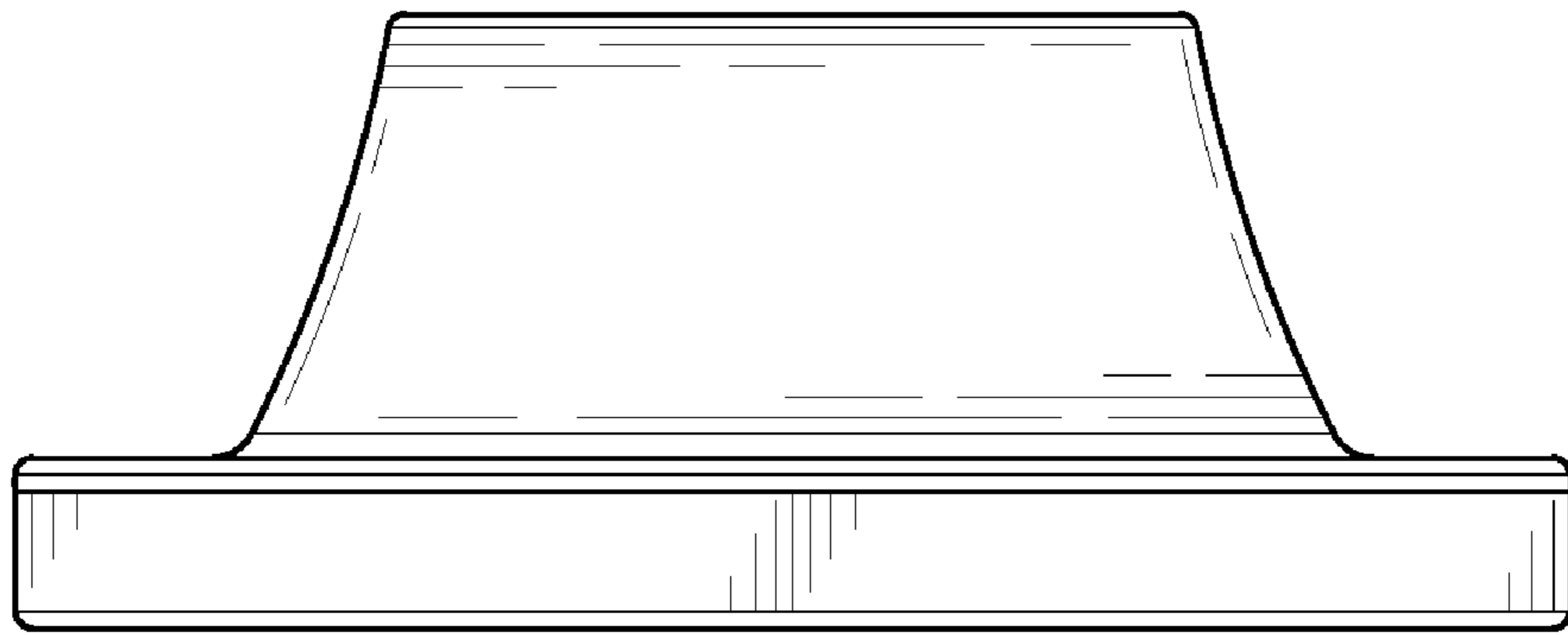

FIG.2

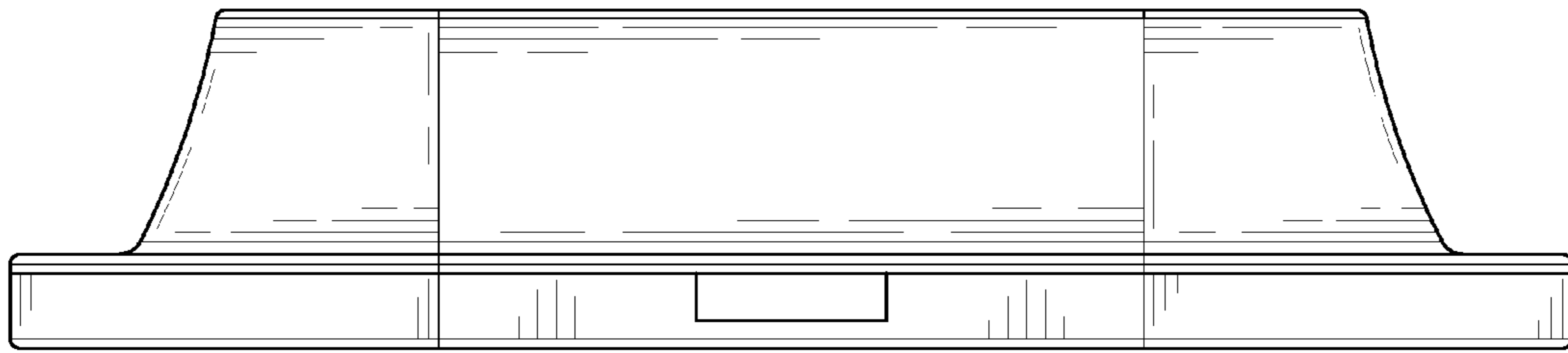

FIG.3

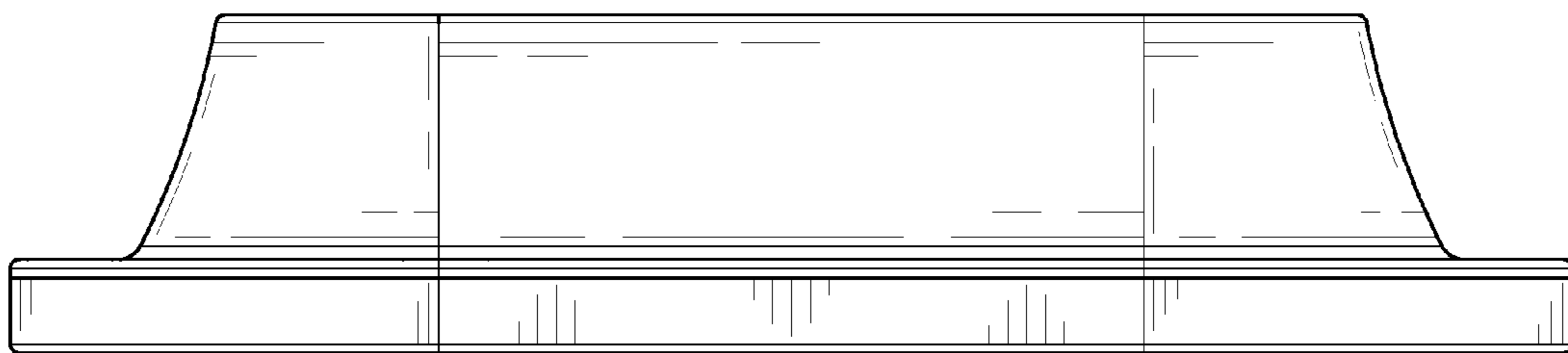

FIG.4

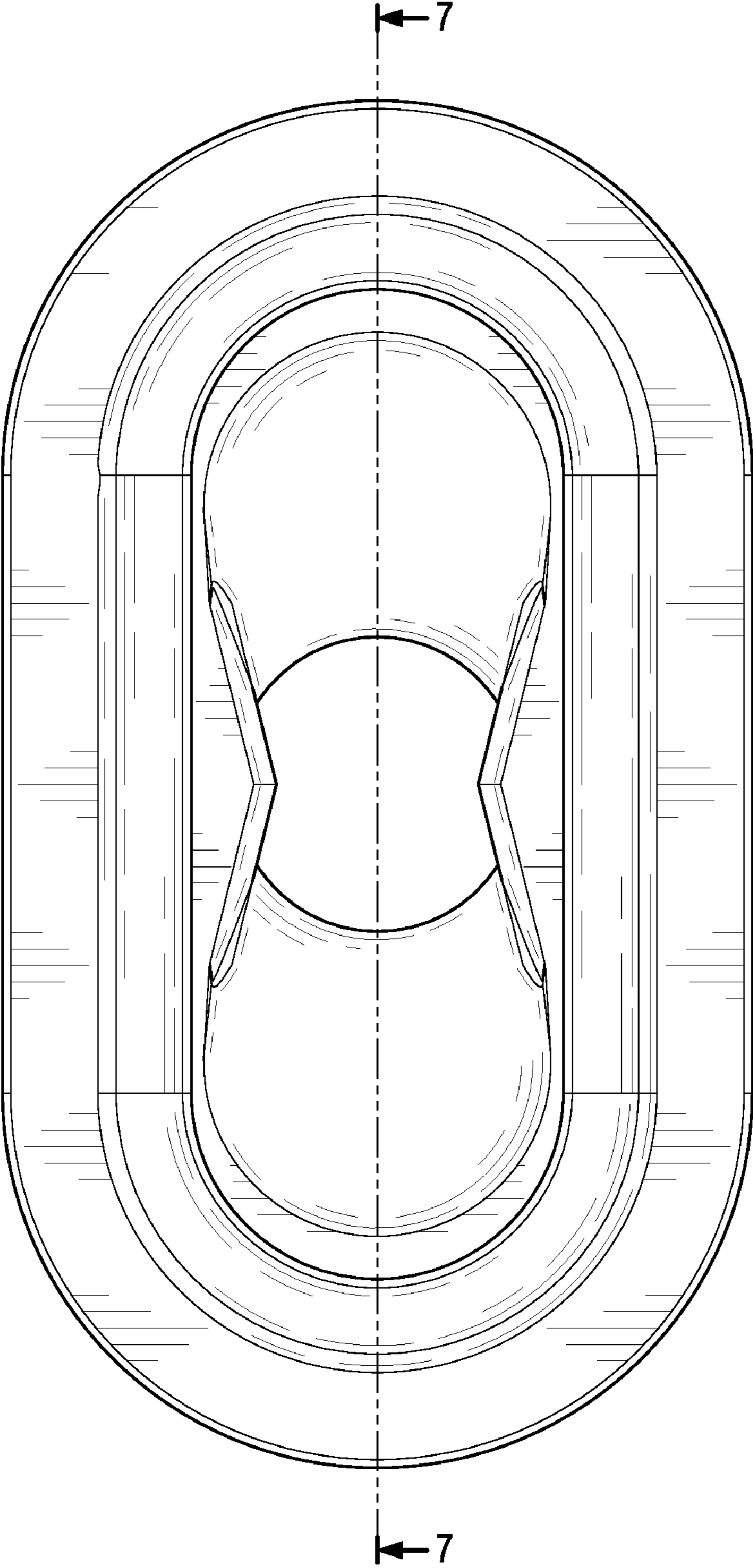

FIG.5

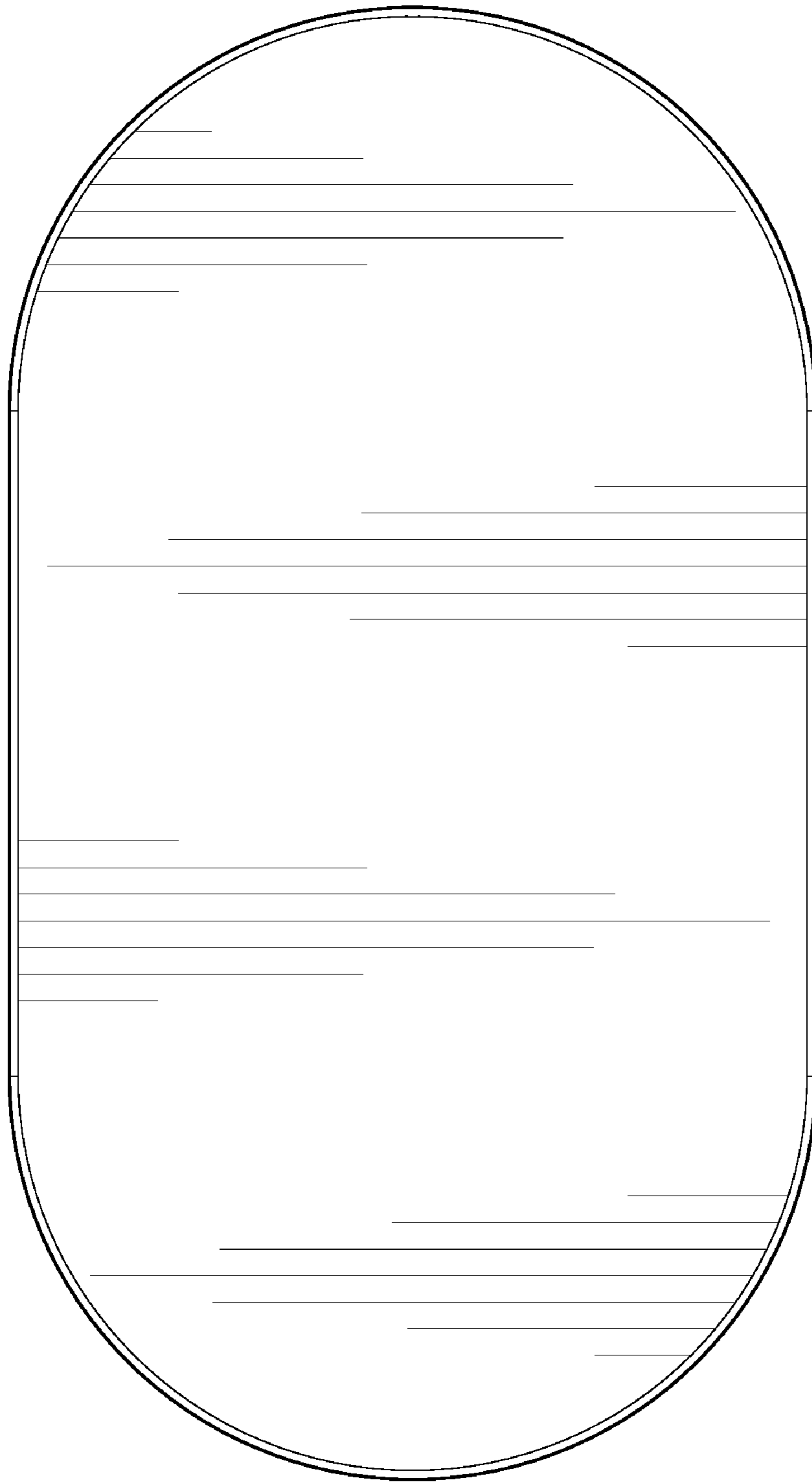

FIG.6

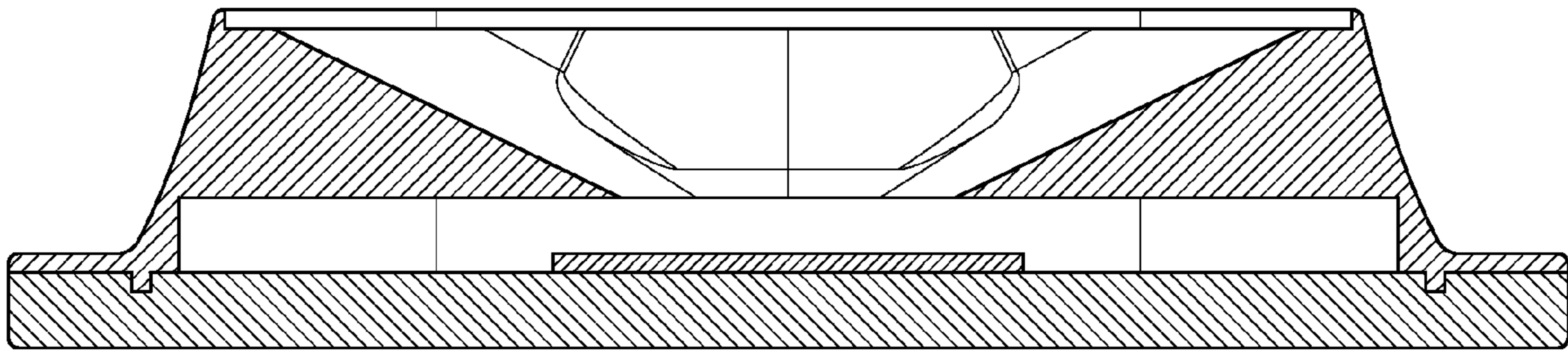

FIG. 7