



US00D604276S

(12) **United States Design Patent**
Schneider et al.

(10) **Patent No.:** **US D604,276 S**
(45) **Date of Patent:** **** Nov. 17, 2009**

(54) **ANTENNA ELEMENT**

3,434,145 A 3/1969 Wells
4,184,163 A 1/1980 Woodward
D318,673 S * 7/1991 Terk D14/230

(75) Inventors: **Richard E. Schneider**, Wildwood, MO (US); **John Edwin Ross, III**, Salt Lake City, UT (US)

(Continued)

(73) Assignee: **Antennas Direct, Inc.**, Eurkea, MO (US)

FOREIGN PATENT DOCUMENTS

JP D1213590 6/2004

(Continued)

(**) Term: **14 Years**

OTHER PUBLICATIONS

(21) Appl. No.: **29/305,294**

Frequency-and Time-Domain Modeling of Tapered Loop Antennas in Ultra-Wideband Radio Systems, Shiou-Li Chen and Shau-Gang Mao, Graduate Institute of Computer and Communication Engineer, pp. 179-182, IEEE copyright notice 2006.

(22) Filed: **Mar. 17, 2008**

(Continued)

Related U.S. Application Data

(63) Continuation-in-part of application No. 12/040,464, filed on Feb. 29, 2008, application No. 29/305,294, and a continuation of application No. 12/050,133, filed on Mar. 17, 2008, which is a continuation-in-part of application No. 12/040,464.

Primary Examiner—T. Chase Nelson
Assistant Examiner—John Windmuller
(74) *Attorney, Agent, or Firm*—Harness, Dickey & Pierce, P.L.C.

(51) **LOC (9) Cl.** **14-03**

(57) **CLAIM**

(52) **U.S. Cl.** **D14/230; D14/234**

The ornamental design for an antenna element, as shown and described.

(58) **Field of Classification Search** D14/230–238, D14/299, 358, 240; 343/700 R, 840, 841, 343/908; 455/3.02, FOR. 215, 575.2; D22/115; 473/578; D13/184

DESCRIPTION

See application file for complete search history.

FIG. 1 is a perspective view of the antenna element, showing our new design;

(56) **References Cited**

U.S. PATENT DOCUMENTS

2,480,155 A * 8/1949 Masters 343/795
D170,203 S 8/1953 Leonard
D171,560 S * 2/1954 Rutter D14/230
D177,200 S * 3/1956 Valiulis D14/230
D179,111 S * 11/1956 Ballan et al. D14/234
3,015,101 A 12/1961 Turner et al
3,123,826 A 3/1964 Durham
3,239,838 A * 3/1966 Kelleher 343/789
3,273,158 A * 9/1966 Fouts et al. 343/792
D209,402 S * 11/1967 Burlingame D14/234
D211,025 S * 5/1968 Callaghan D14/234

FIG. 2 is a front elevation view thereof;

FIG. 3 is a back elevation thereof;

FIG. 4 is a bottom plan view thereof;

FIG. 5 is a top plan view thereof;

FIG. 6 is a right elevation view thereof;

FIG. 7 is a left elevation view thereof; and,

FIG. 8 is a perspective view thereof in use.

In the drawings, the broken lines depict environmental subject matter only and form no part of the claimed design.

1 Claim, 8 Drawing Sheets

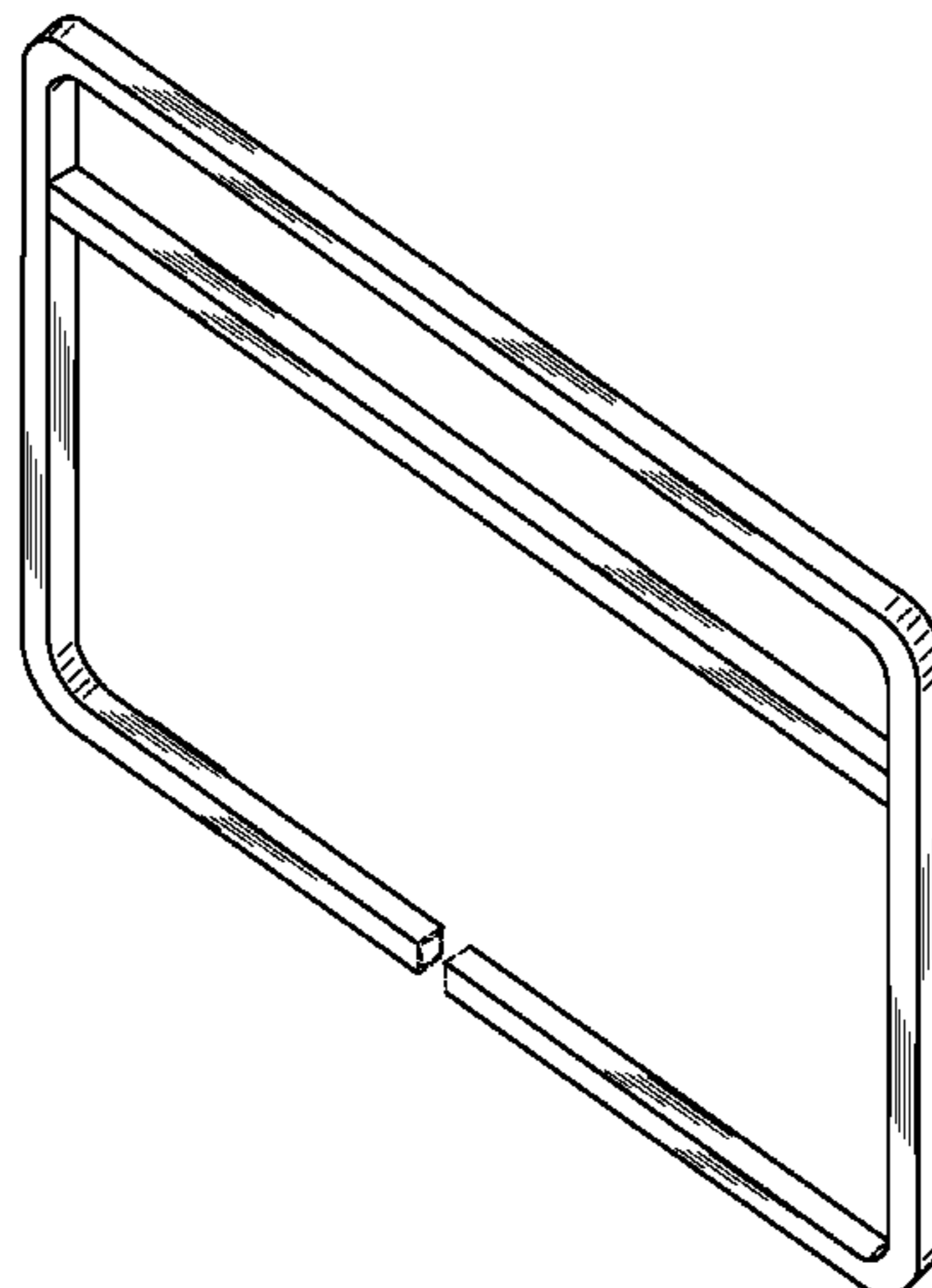

U.S. PATENT DOCUMENTS

D327,690	S	7/1992	Ogawa et al.	
D344,731	S *	3/1994	Witzky	D14/230
5,313,218	A	5/1994	Busking	
D414,495	S	9/1999	Heiligenstein et al.	
6,593,886	B2	7/2003	Schantz	
6,680,708	B2	1/2004	Yamaki	
6,885,352	B2	4/2005	Lee et al.	
7,091,925	B1	8/2006	Wang	
7,209,089	B2	4/2007	Schantz	
D544,471	S *	6/2007	Wang	D14/230
7,239,290	B2	7/2007	Poilasne et al.	
2002/0158798	A1	10/2002	Chiang et al.	
2004/0090379	A1	5/2004	Fourdeux et al.	
2004/0090385	A1	5/2004	Green	
2004/0113841	A1	6/2004	Louzir et al.	
2004/0217912	A1	11/2004	Mohammadian	
2005/0088342	A1	4/2005	Parsche	
2005/0280582	A1	12/2005	Powell et al.	
2006/0033665	A1	2/2006	Yang	
2006/0077115	A1 *	4/2006	Oh et al.	343/895
2006/0103577	A1	5/2006	Lee	
2006/0164304	A1	7/2006	Huang et al.	
2007/0069955	A1	3/2007	McCorkle	
2007/0200769	A1	8/2007	Nakano et al.	
2008/0094291	A1	4/2008	Bystrom et al.	
2008/0211720	A1	9/2008	Hansen	
2008/0258980	A1	10/2008	Chen et al.	
2009/0058732	A1	3/2009	Nakano et al.	
2009/0073067	A1	3/2009	Soler Castany et al.	

FOREIGN PATENT DOCUMENTS

TW	D112283	8/2006
----	---------	--------

TW

D119092

9/2007

OTHER PUBLICATIONS

Planar Miniature Tapered-Slot-Fed Annular Slot Antennas for Ultrawide-Band Radios, Tzyh-Ghuang Ma, Student Member, and Shyh-Kang, Jeng, Senior Member, IEEE, IEEE Transactions on Antennas and Propagation, vol. 53, No. 3, Mar. 2005, pp. 1194-1202.

Self-Mutual Admittances of Two Identical Circular Loop Antennas in a Conducting Medium and in Air, K. Iizuka, Senior Member, IEEE, R. W. P. King, Fellow, IEEE, and C. W. Harrison, Jr., Senior Member, IEEE, IEEE Transactions on Antennas and Propagation, vol. AP014, No. 4, Jul. 1966, pp. 440-450.

A Broadband Eccentric Annular Slot Antenna, Young Hoon Suh and Ikmo Park, Department of Electrical Engineering, Ajou University, pp. 94-97, IEEE copyright notice 2001.

A Printed Crescent Patch Antenna for Ultrawideband Applications, Ntsanderh C. Azenui an H.Y.D. Yang, IEEE Antennas and Wireless Propagation Letters, vol. 6, 2007, pp. 113-116.

Design of Compact Components for Ultra Wideband Communication Front Ends, Marek Bialkowski, Amin Abbosh, and Hing Kan, School of Information Technology and Electrical Engineering, The University of Queensland, four pages.

IEEE Spectrum: Antennas for the New Airwaves, <http://www.spectrum.ieee.org/print/7328>, Published Feb. 2009, 9 pages, Authors Richard Schneider and John Ross.

Antenna Engineering Handbook, 3rd Edition, Edited by Richard C. Johnson, McGraw Hill, 1993, pp. 5-13 to 5-16.

One-Element Loop Antenna with Finite Reflector, B. Rojarayanont and T. Sekiguchi, Electronics & Communications in Japan, vol. 59-B, No. 5, May 1976, p. 68.

* cited by examiner

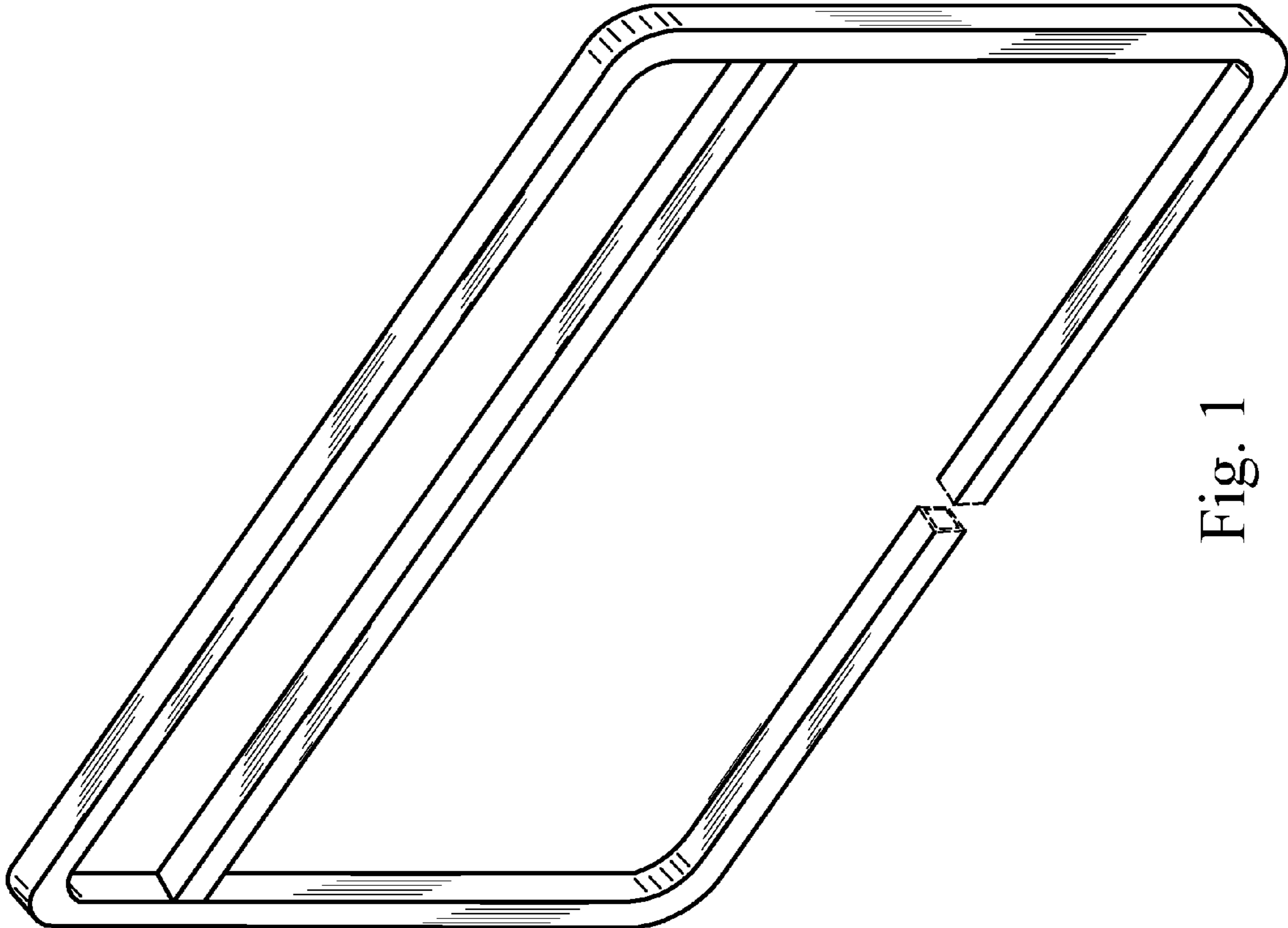

Fig. 1

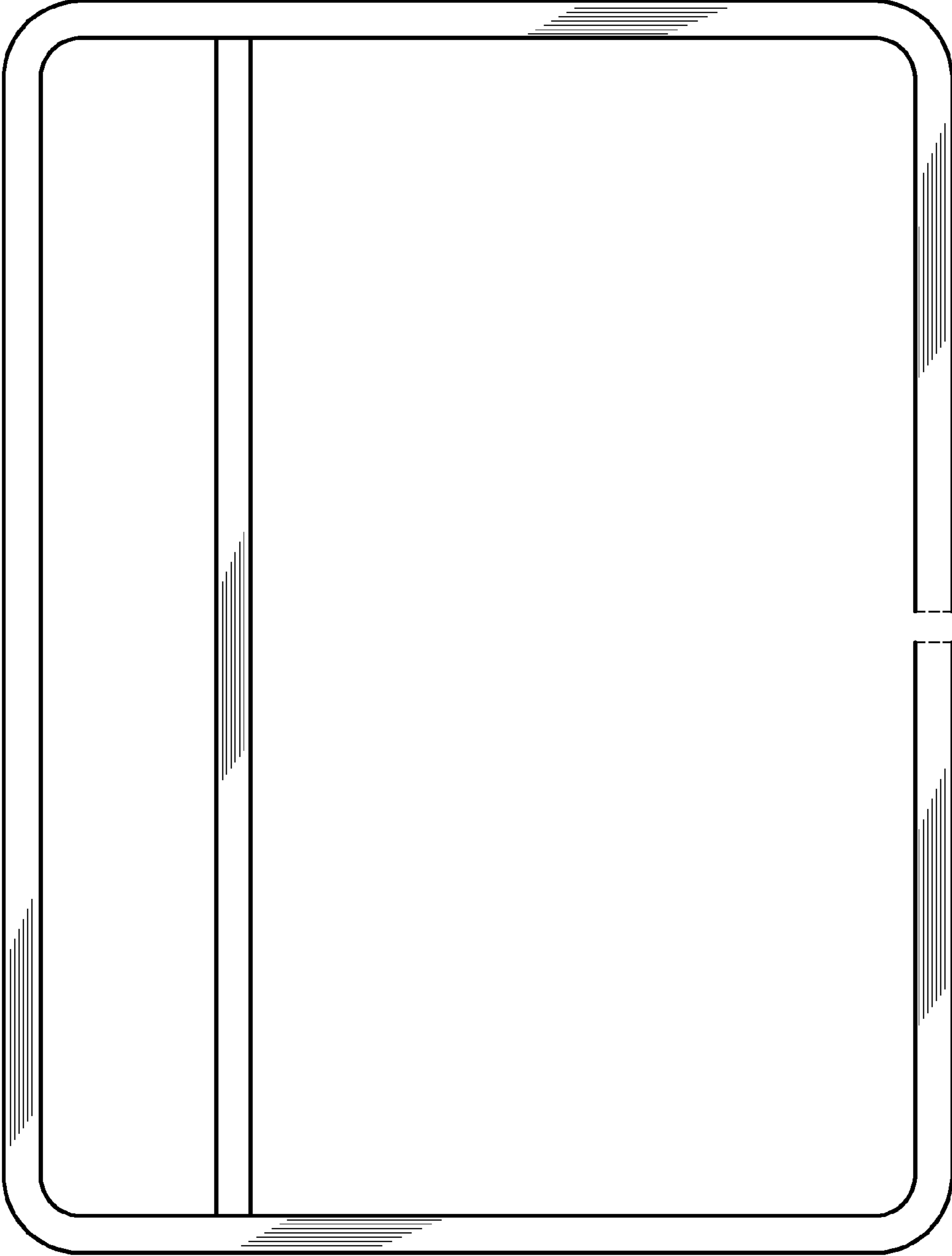

Fig. 2

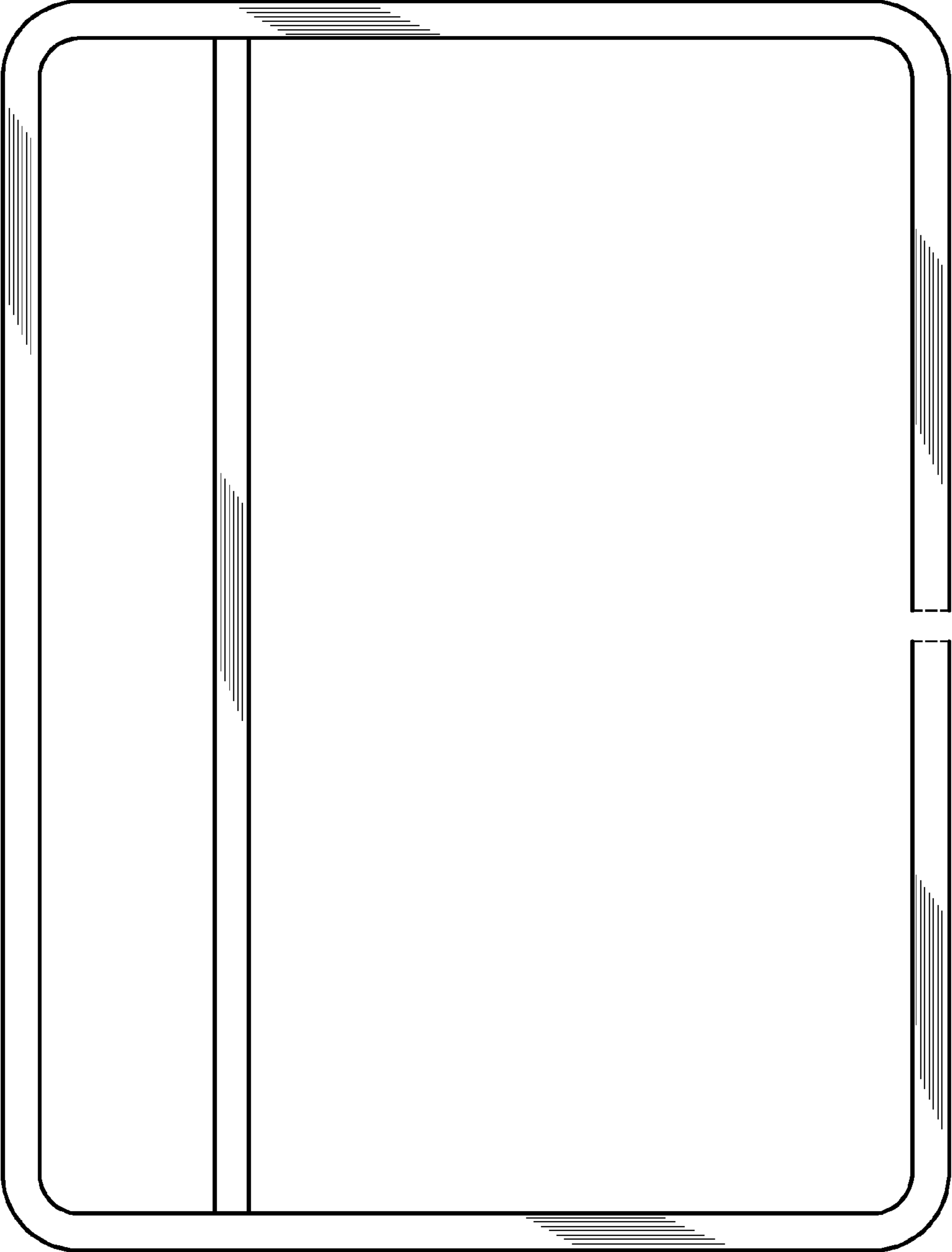

Fig. 3

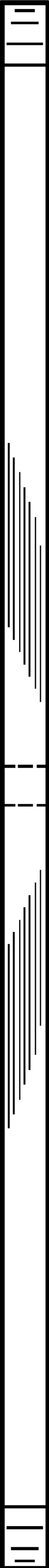

Fig. 4



Fig. 5



Fig. 6



Fig. 7

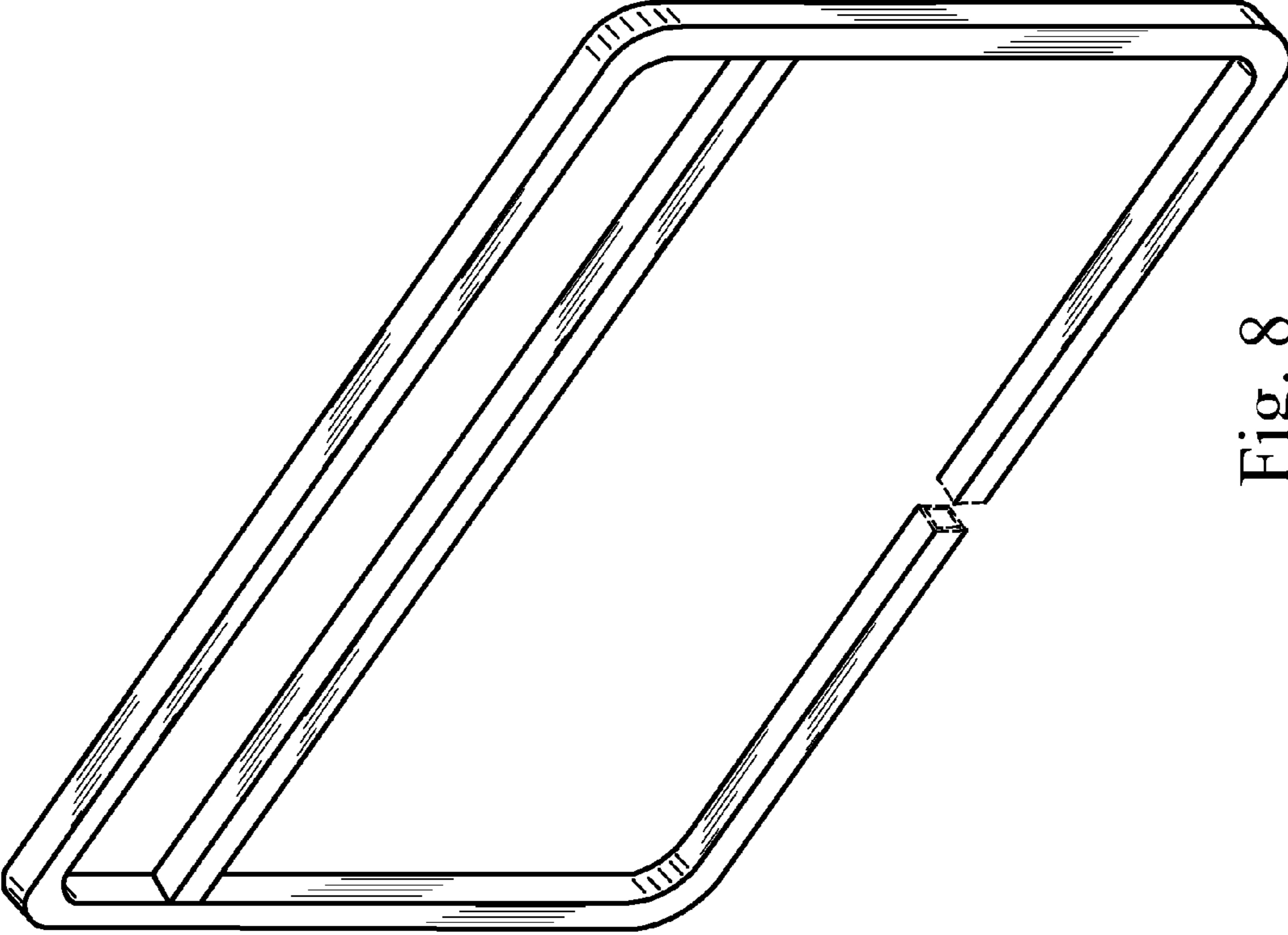
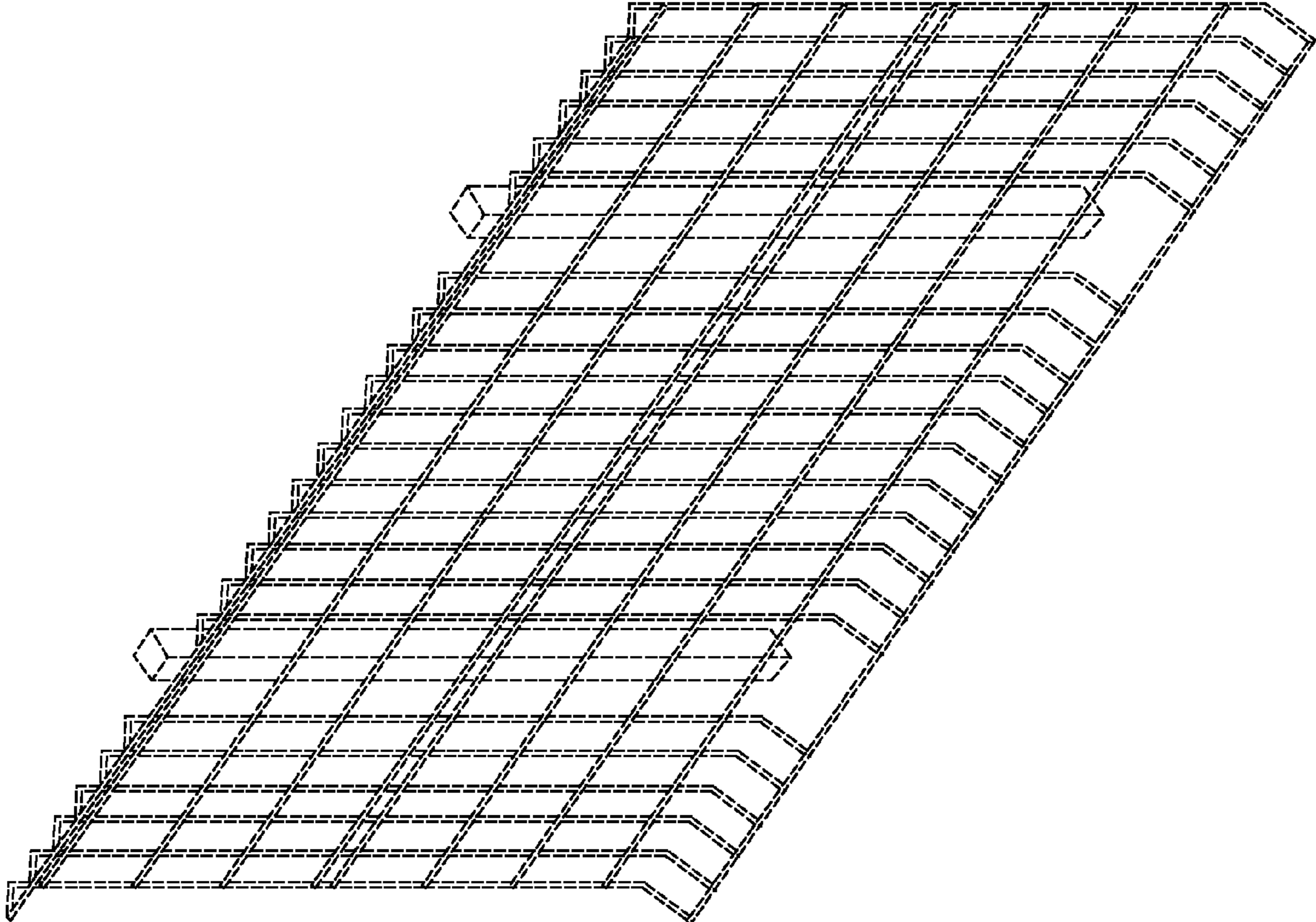

Fig. 8