



US00D603981S

(12) **United States Design Patent**
King

(10) **Patent No.:** **US D603,981 S**

(45) **Date of Patent:** **** *Nov. 10, 2009**

(54) **CORNER PIECE**

(75) Inventor: **Daniel W. King**, Copley, OH (US)

(73) Assignee: **TAPCO International Corporation**,
Wixom, MI (US)

(*) Notice: This patent is subject to a terminal disclaimer.

(**) Term: **14 Years**

(21) Appl. No.: **29/275,171**

(22) Filed: **Dec. 15, 2006**

(51) **LOC (9) Cl.** **25-01**

(52) **U.S. Cl.** **D25/139**

(58) **Field of Classification Search** D25/138-143,
D25/136, 102, 124, 199; 52/407.1, 406.1,
52/520, 406.2, 555, 406.3, 174, 320, 325,
52/407.2, 323, 532, 404.1, 519, 287.1, 288.1,
52/312

See application file for complete search history.

(56) **References Cited**

U.S. PATENT DOCUMENTS

2,110,258	A *	3/1938	Blank	D25/139
D366,336	S *	1/1996	Noone et al.	D25/139
7,127,869	B2 *	10/2006	Perry	52/288.1
D573,726	S *	7/2008	Coates	D25/139

* cited by examiner

Primary Examiner—Catherine R Oliver

(74) *Attorney, Agent, or Firm*—Howard & Howard Attorneys
PLLC

(57) **CLAIM**

I claim the ornamental design for a corner piece, as shown herein.

DESCRIPTION

FIG. 1 is a bottom perspective view of an exterior of a corner piece illustrating shake siding elements,

FIG. 2 is a left side view of the exterior of the corner piece of FIG. 1,

FIG. 3 is a right side view of an interior of the corner piece of FIG. 1,

FIG. 4 is a right side view of the exterior of the corner piece of FIG. 1,

FIG. 5 is a left side view of the interior of the corner piece of FIG. 1,

FIG. 6 is a bottom perspective view of the interior of the corner piece of FIG. 1,

FIG. 7 is a top view of the corner piece of FIG. 1,

FIG. 8 is a bottom view of the corner piece of FIG. 1,

FIG. 9 is a bottom perspective view of a second embodiment of the design shown in FIGS. 1-8, the only differences residing in the length of the shake siding elements of the corner piece and the number of shake siding elements shown,

FIG. 10 is a left side view of the exterior of the corner piece of FIG. 9,

FIG. 11 is a right side view of an interior of the corner piece of FIG. 9,

FIG. 12 is a right side view of the exterior of the corner piece of FIG. 9,

FIG. 13 is a left side view of the interior of the corner piece of FIG. 9,

FIG. 14 is a bottom perspective view of the interior of the corner piece of FIG. 9,

FIG. 15 is a top view of the corner piece of FIG. 9; and,

FIG. 16 is a bottom view of the corner piece of FIG. 9.

The broken lines shown in the drawings are for illustrative purposes only and form no part of the claimed design.

1 Claim, 8 Drawing Sheets

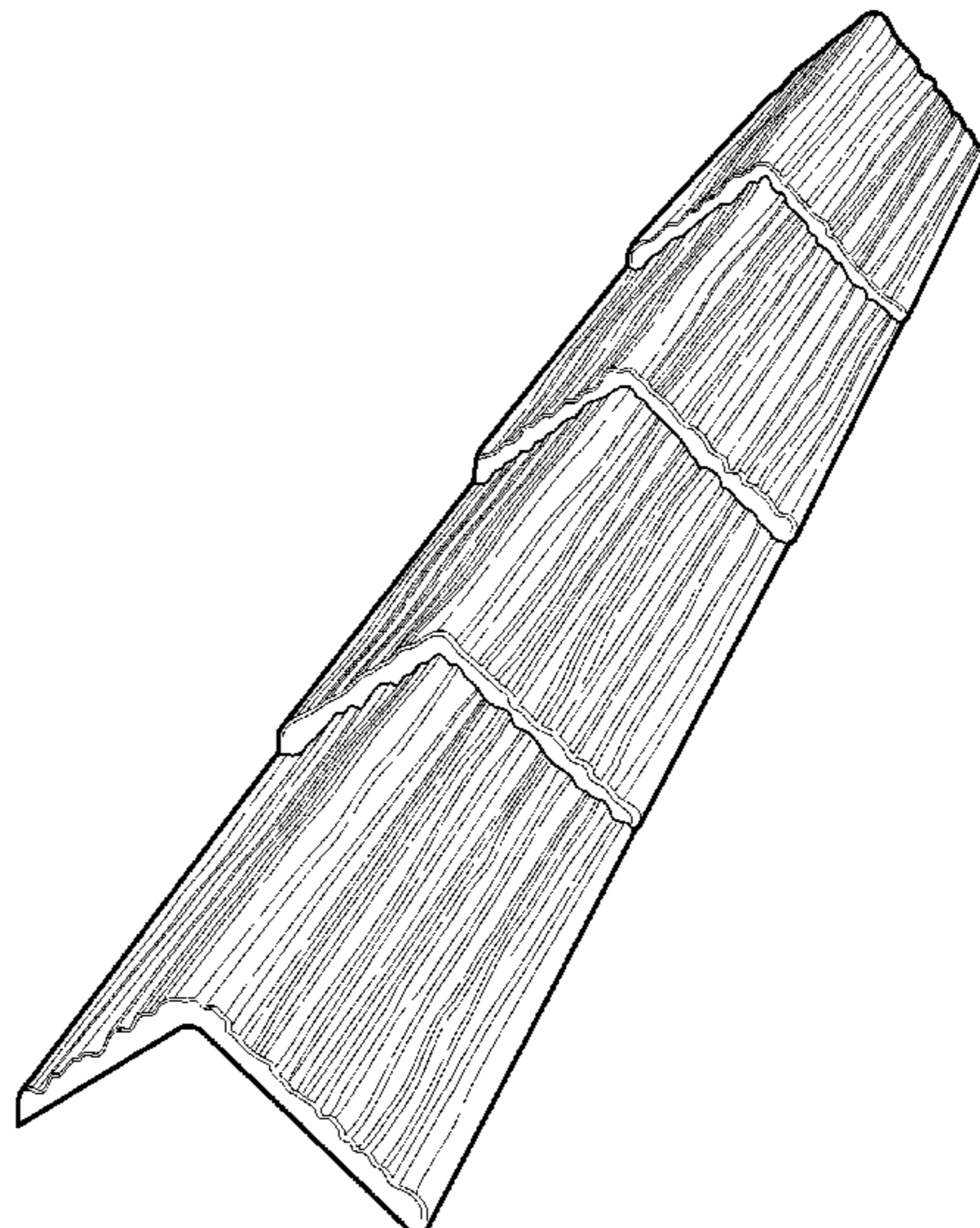

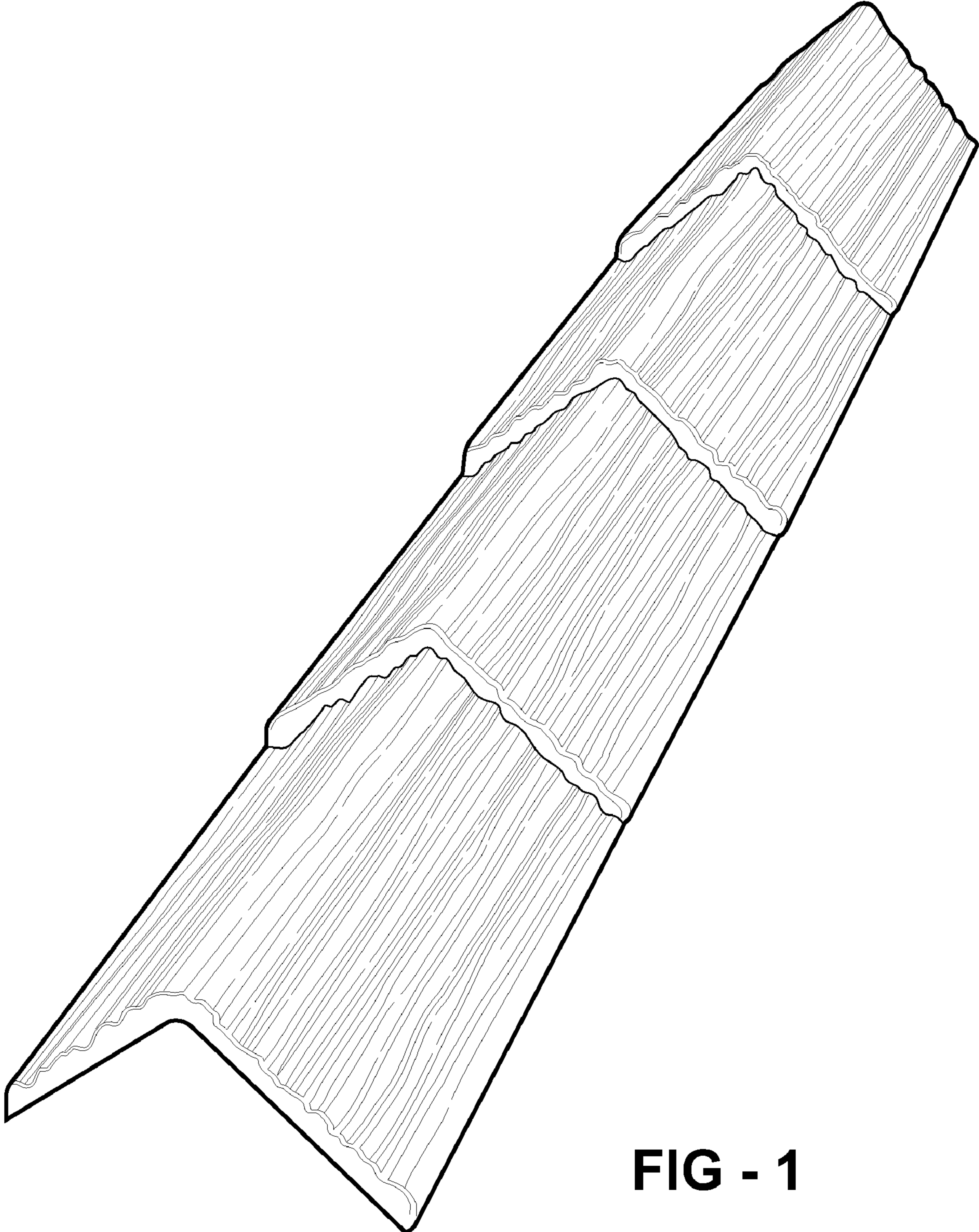

FIG - 1

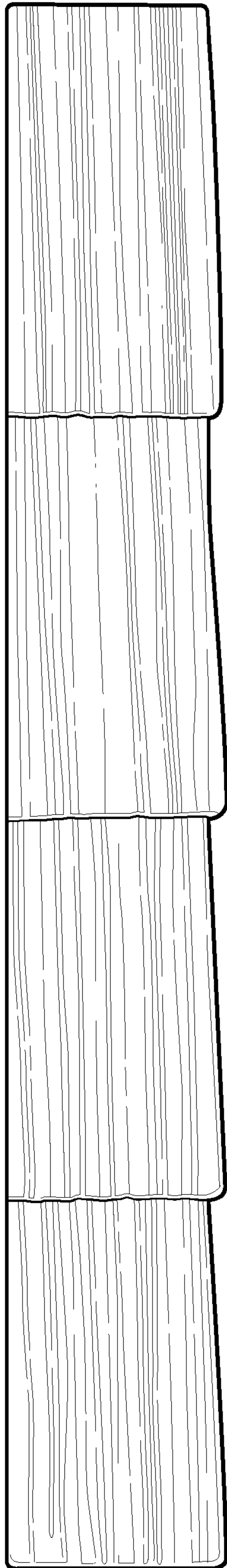

FIG - 2

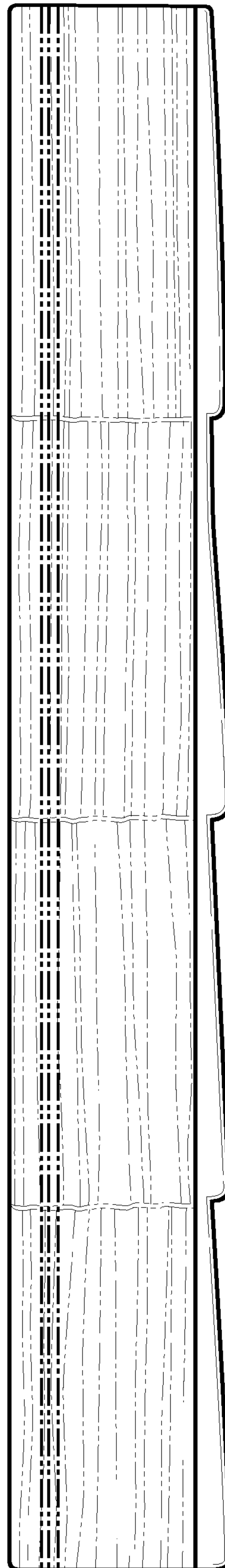

FIG - 3

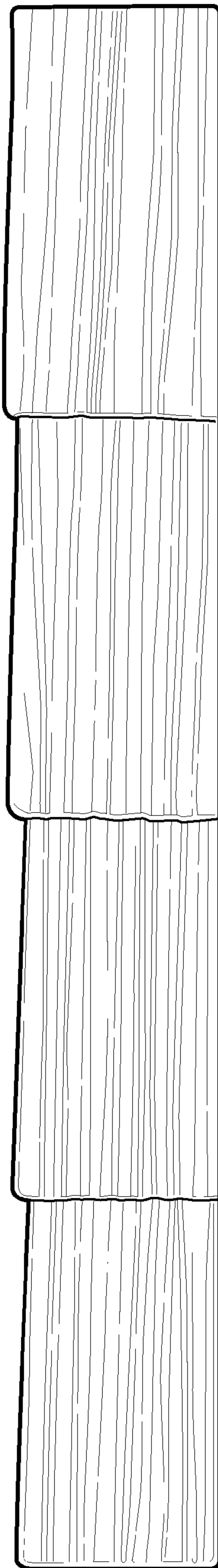

FIG - 4

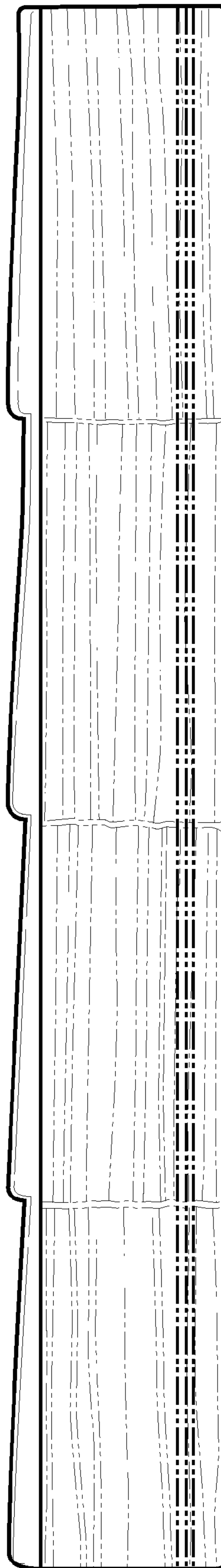

FIG - 5

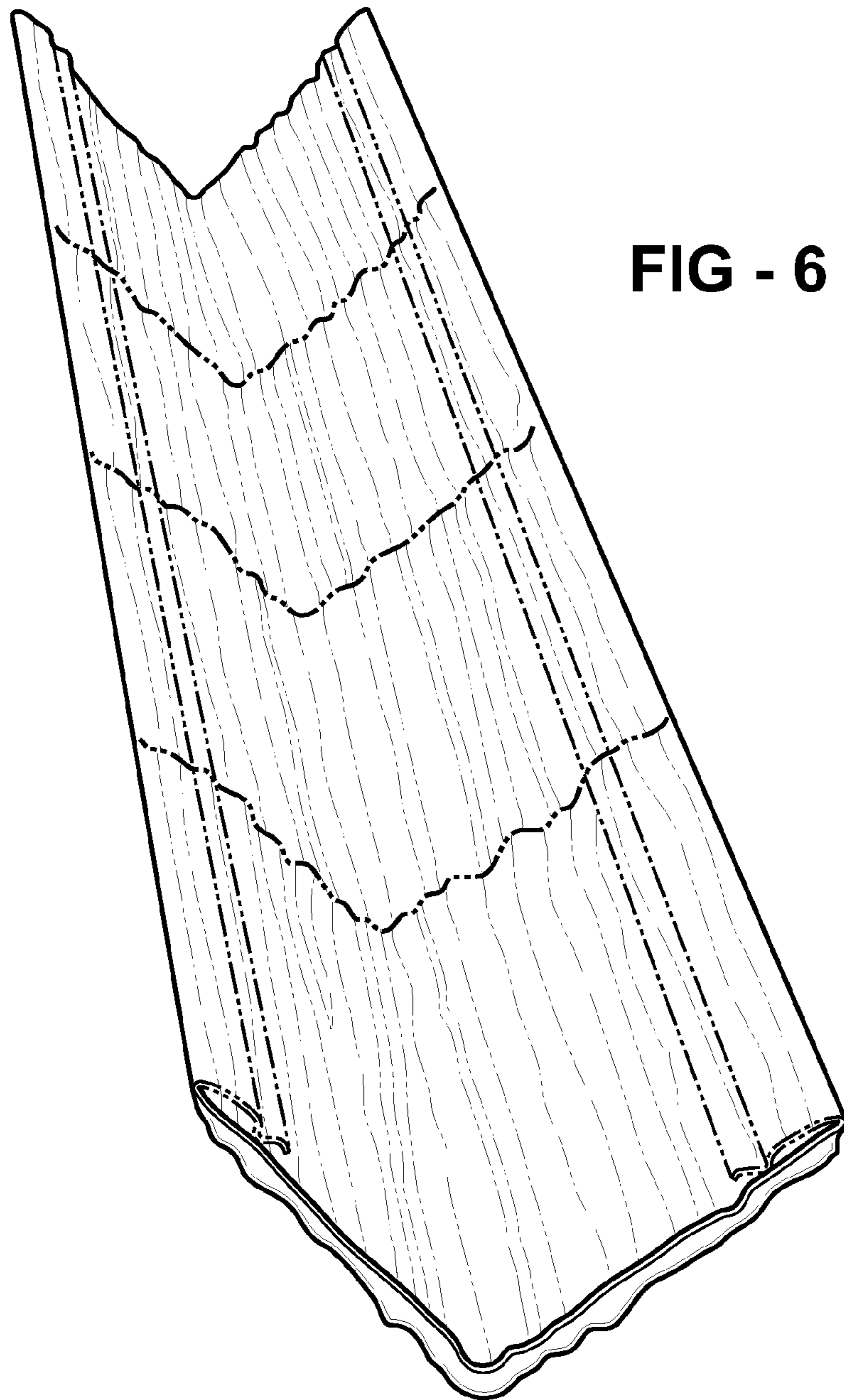

FIG - 6

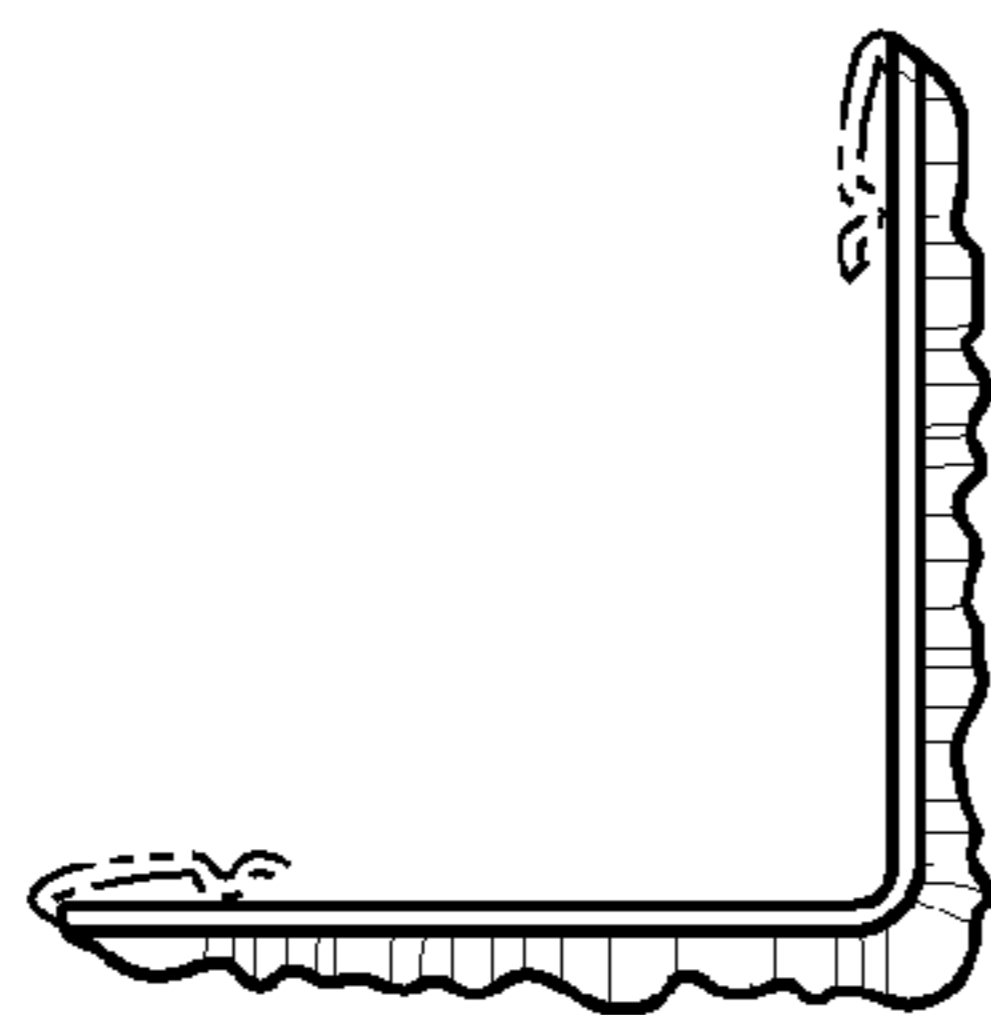

FIG - 7

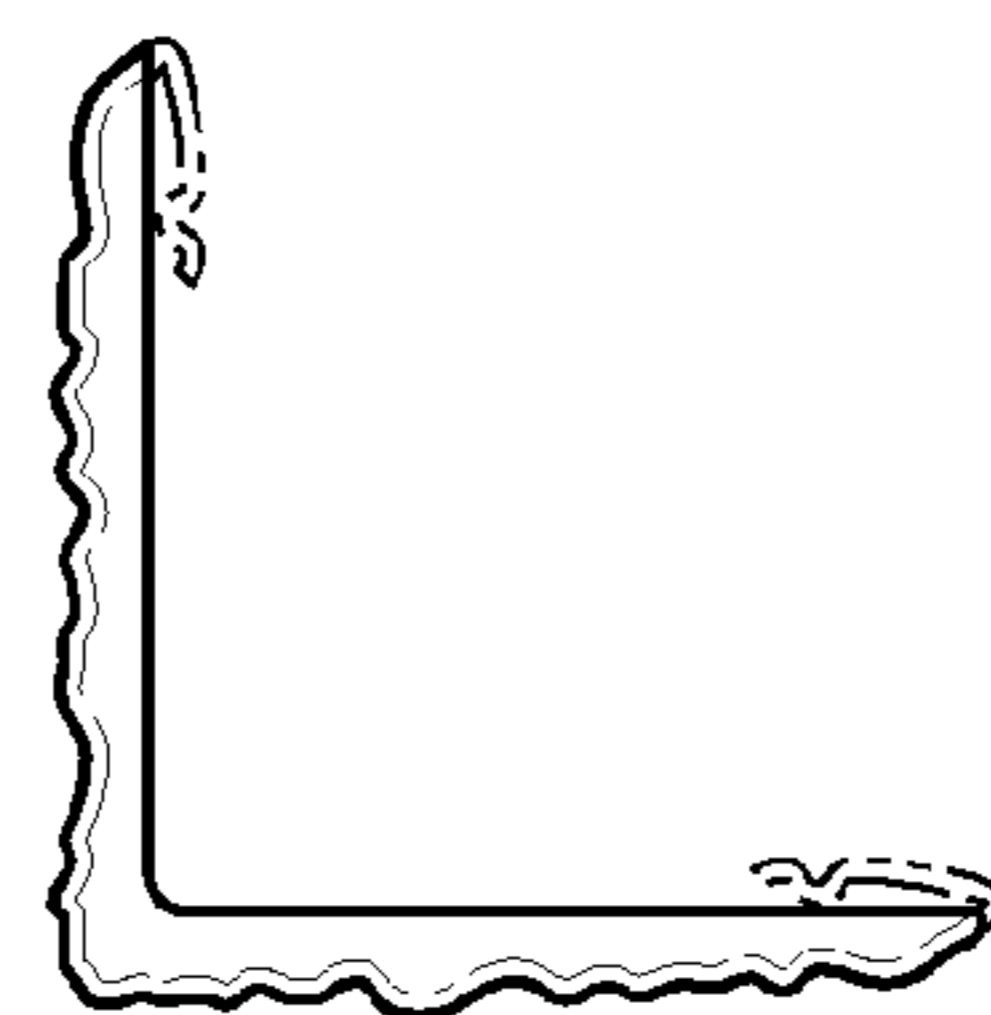

FIG - 8

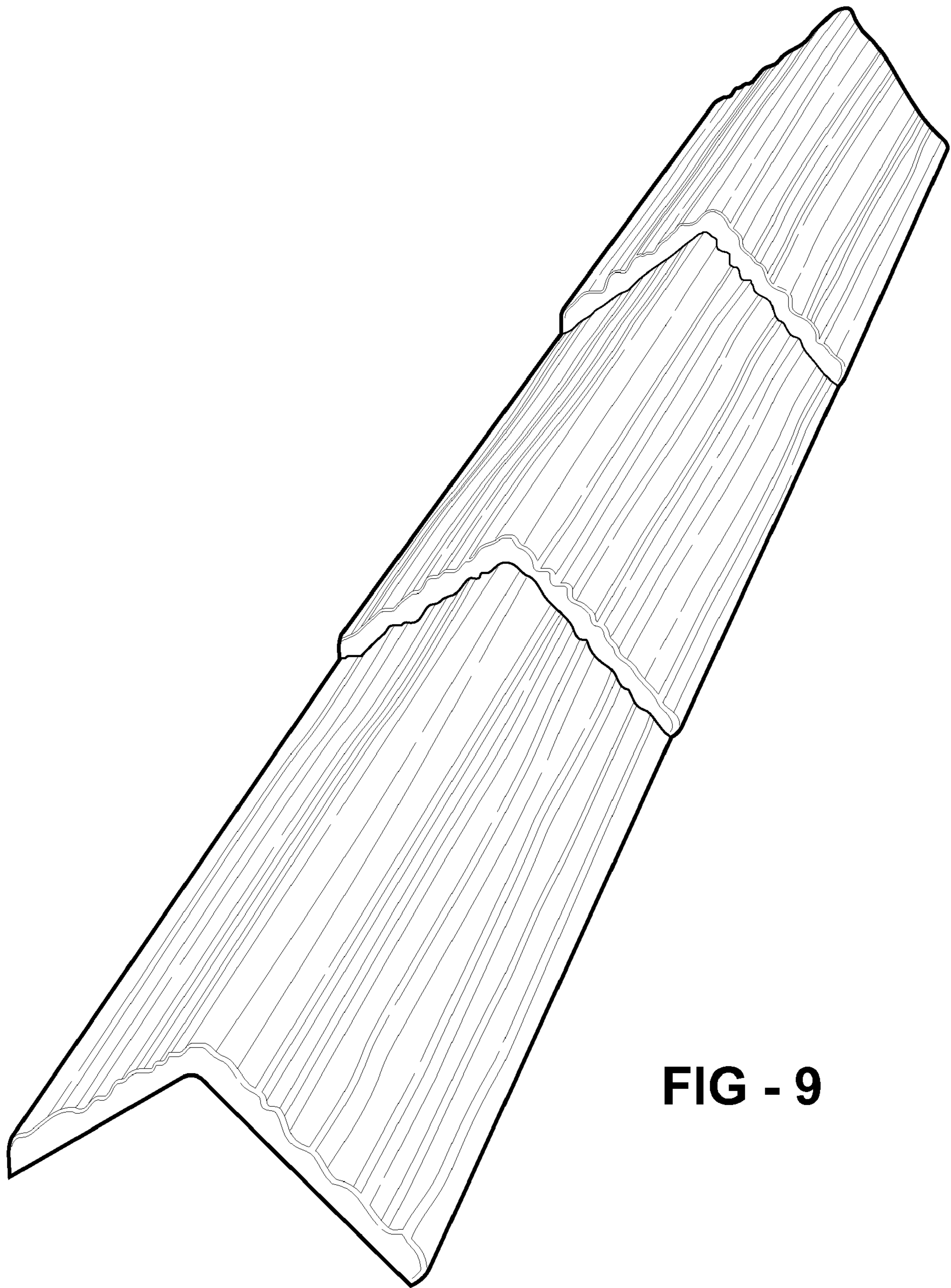

FIG - 9



FIG - 10

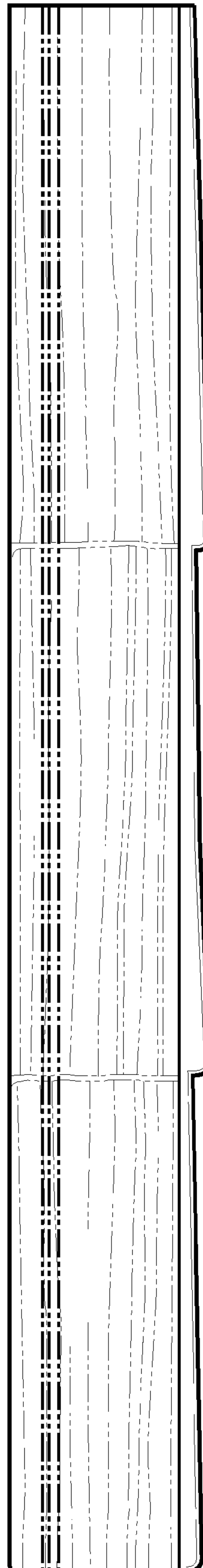

FIG - 11

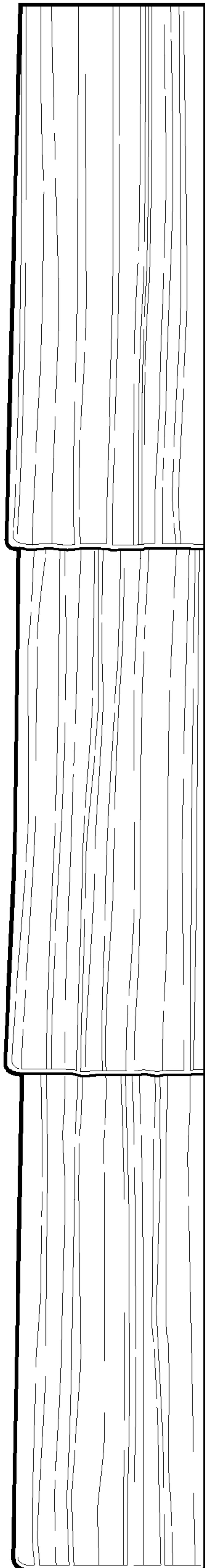

FIG - 12

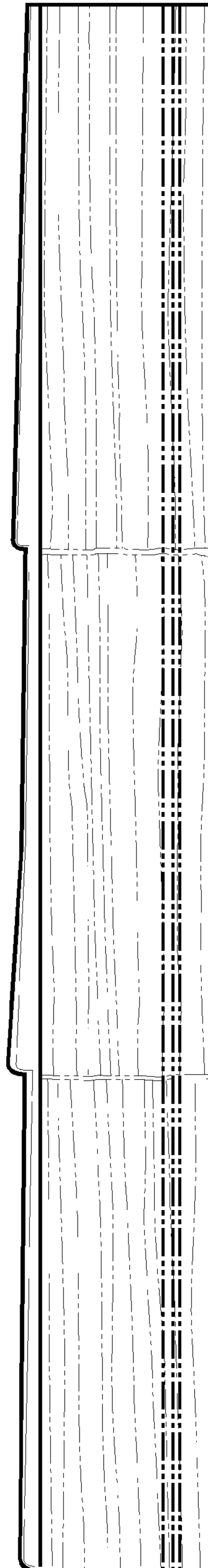

FIG - 13

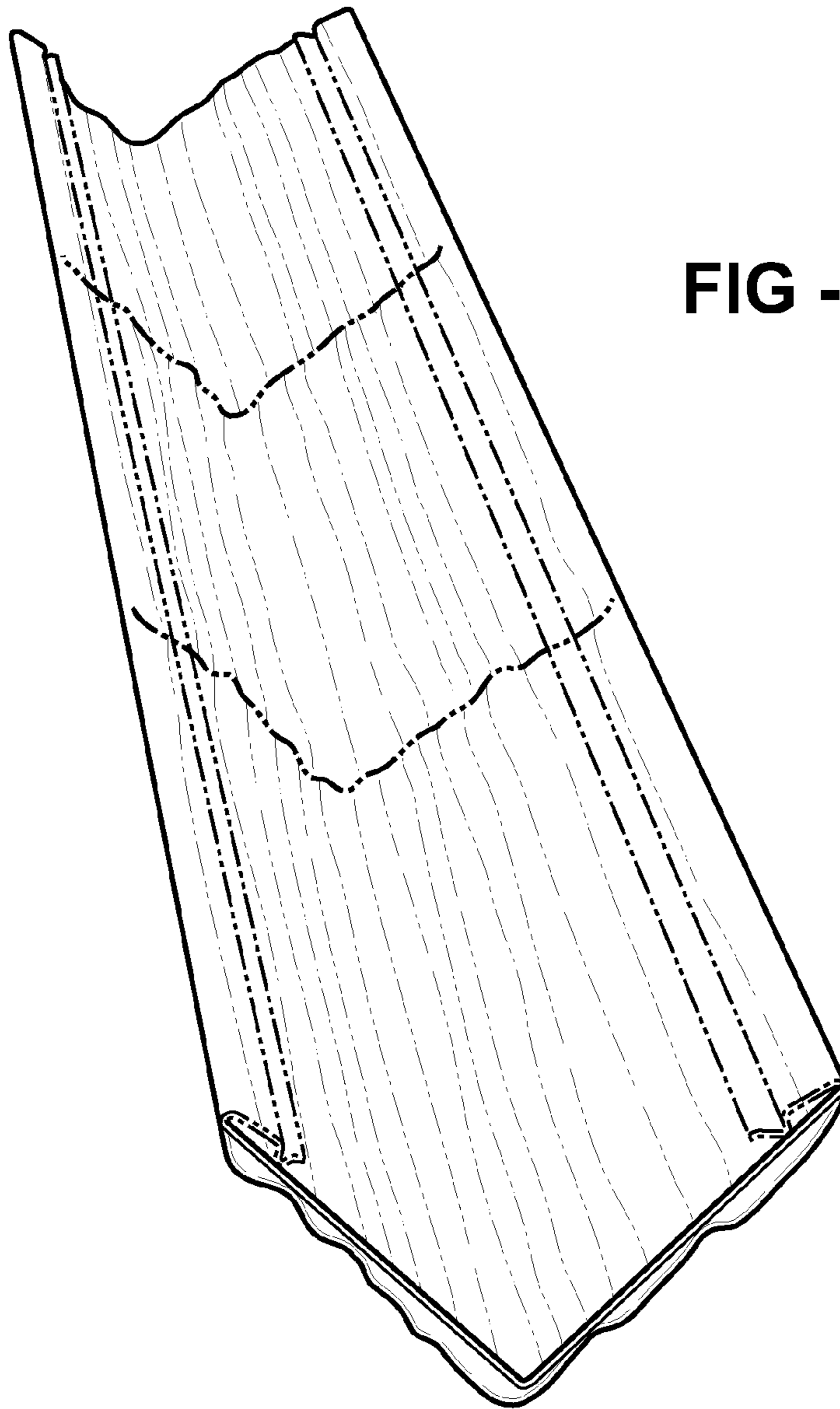

FIG - 14

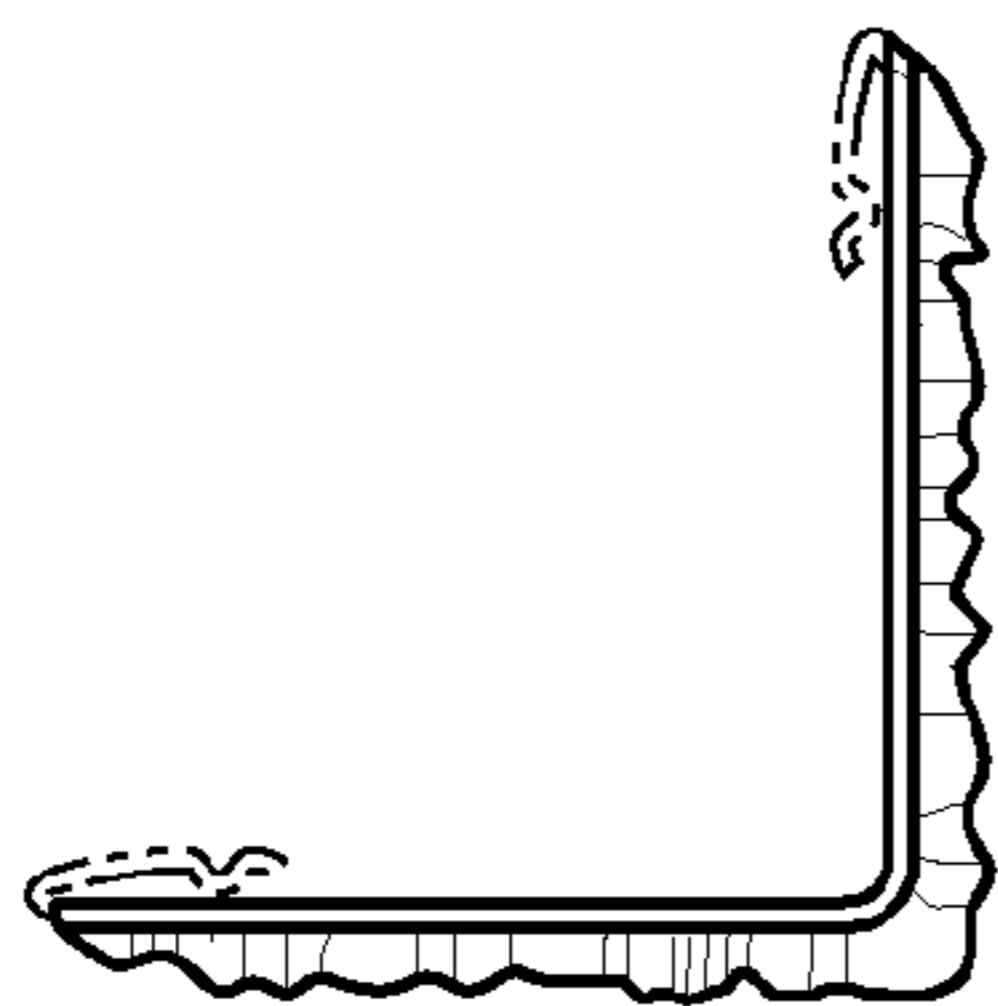

FIG - 15

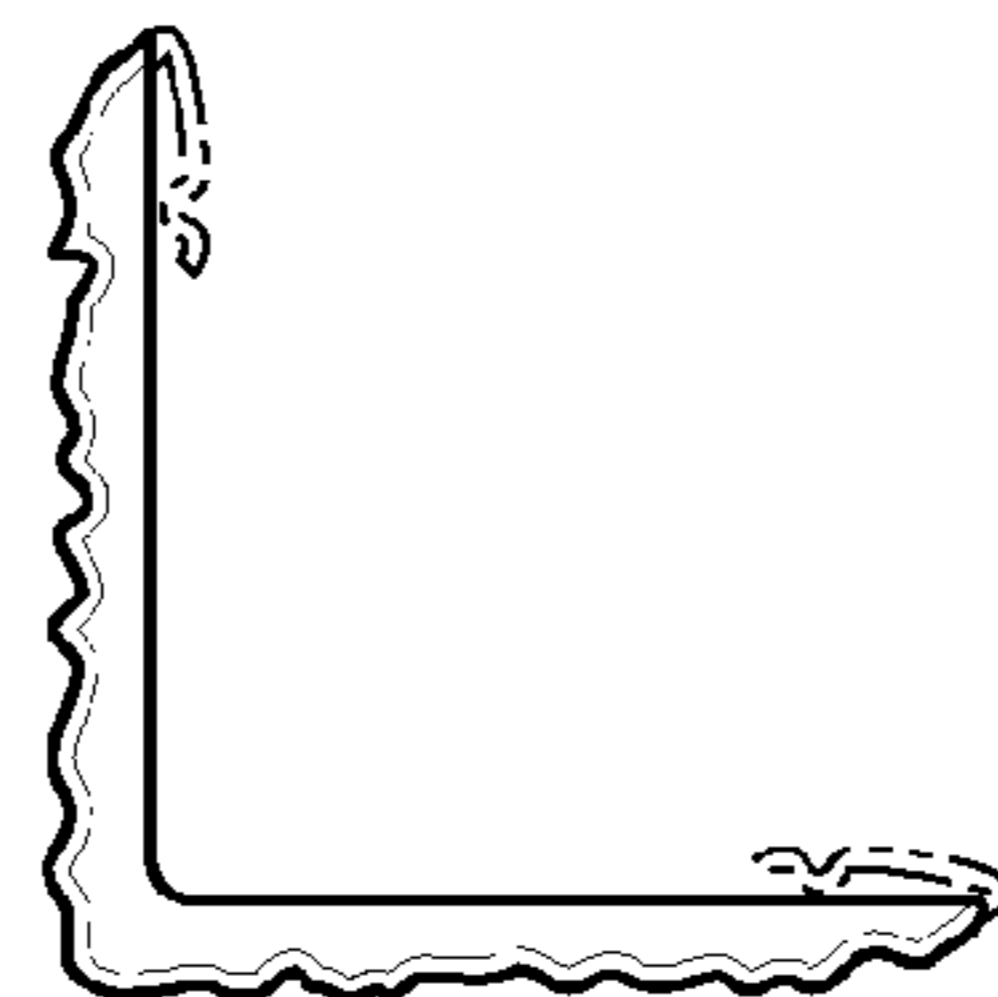

FIG - 16