

US00D603976S

(12) **United States Design Patent**
Pearce

(10) **Patent No.:** **US D603,976 S**

(45) **Date of Patent:** **** Nov. 10, 2009**

(54) **45 DEGREE MASONRY UNIT**

D529,633 S * 10/2006 Zarb D25/136

(76) **Inventor:** **Dennis R. Pearce**, 46 S. Lawson Rd.,
Poquoson, VA (US) 23662

* cited by examiner

Primary Examiner—T. Chase Nelson

Assistant Examiner—Anhdao Doan

(74) *Attorney, Agent, or Firm*—William G. Sykes

(**) **Term:** **14 Years**

(21) **Appl. No.:** **29/313,058**

(57) **CLAIM**

(22) **Filed:** **Dec. 4, 2008**

The ornamental design for a 45 degree masonry unit, as shown and described.

(51) **LOC (9) Cl.** **25-01**

(52) **U.S. Cl.** **D25/114**

(58) **Field of Classification Search** D25/102,
D25/112–118, 136, 138, 152–162, 164; D21/484–491,
D21/499–502; 405/16, 17, 33, 35, 284, 286;
52/503–505, 574, 575, 596–605, 609–612;
404/29–31

See application file for complete search history.

DESCRIPTION

FIG. 1 is a top perspective view of a 45 degree masonry unit showing my new design;

FIG. 2 is a front view thereof;

FIG. 3 is a top view thereof;

FIG. 4 is a bottom view thereof;

FIG. 5 is a right side view thereof shown in an enlarged scale;

FIG. 6 is a left side view thereof shown in a slightly less enlarged scale from that of FIG. 5; and,

FIG. 7 is a back view thereof.

(56) **References Cited**

U.S. PATENT DOCUMENTS

D343,908 S	*	2/1994	Naether	D25/113
D374,465 S	*	10/1996	Schmidt	D21/486
D409,675 S	*	5/1999	Krog	D21/486
D448,858 S	*	10/2001	Azar	D25/113

1 Claim, 7 Drawing Sheets

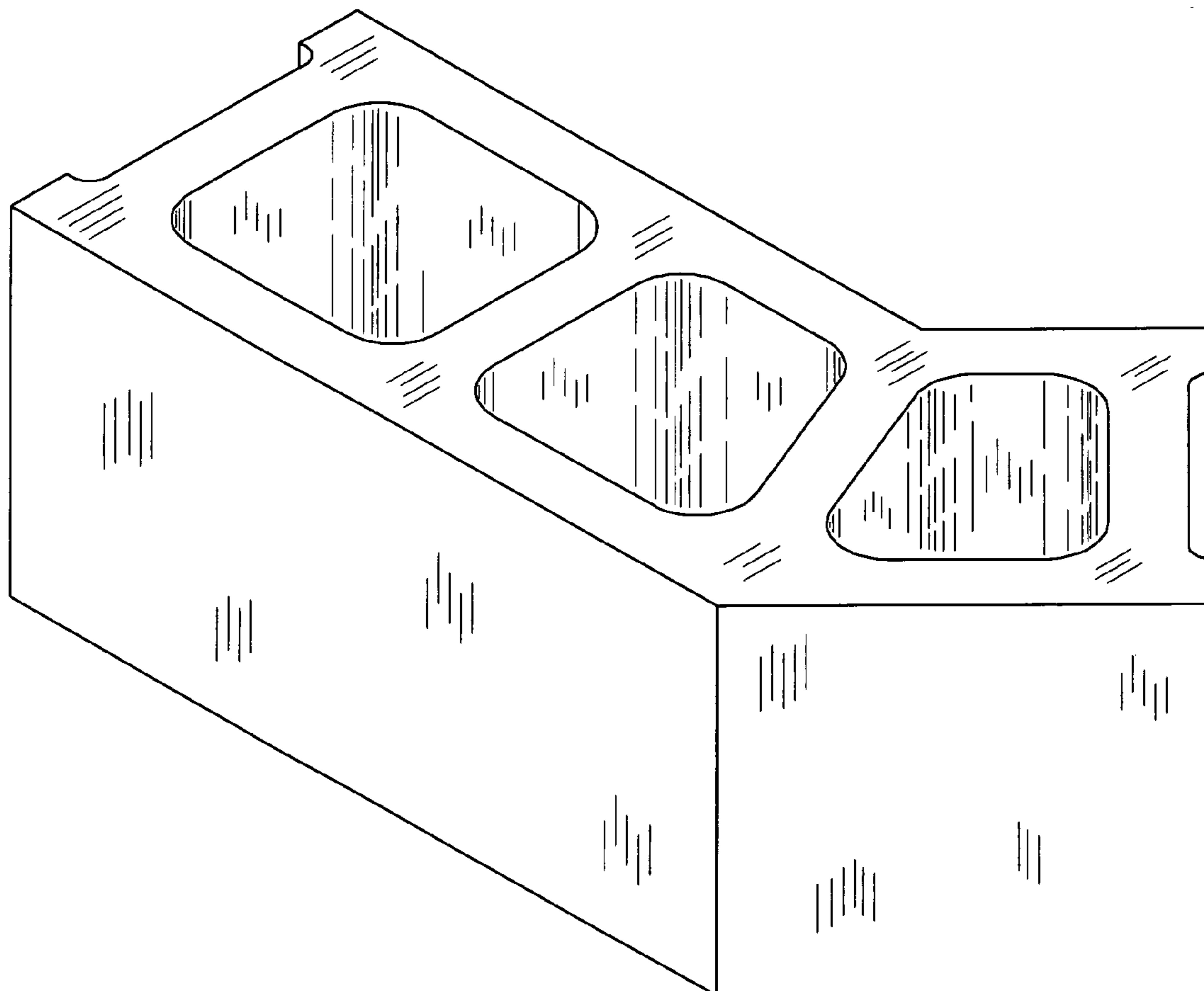

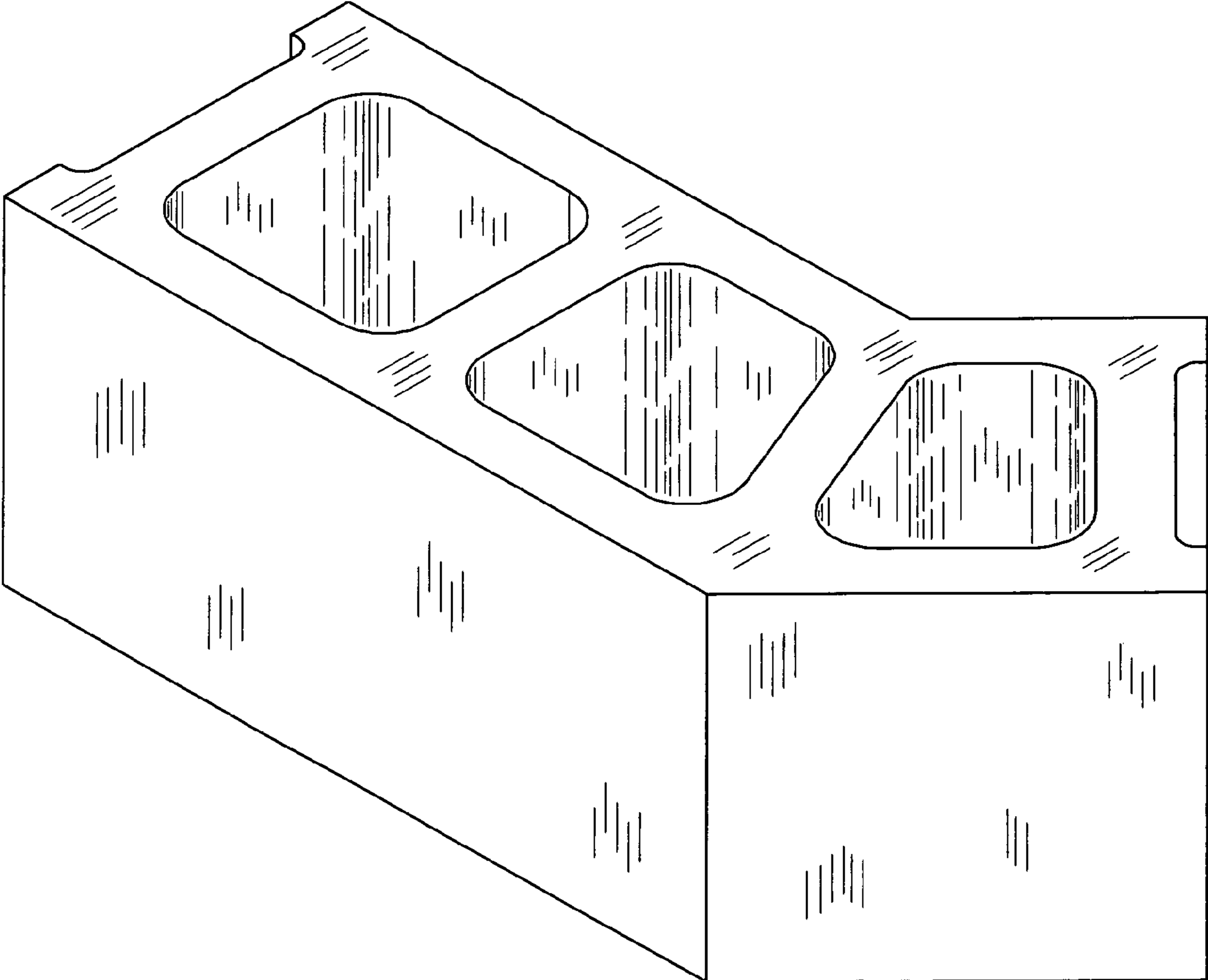

Fig. 1

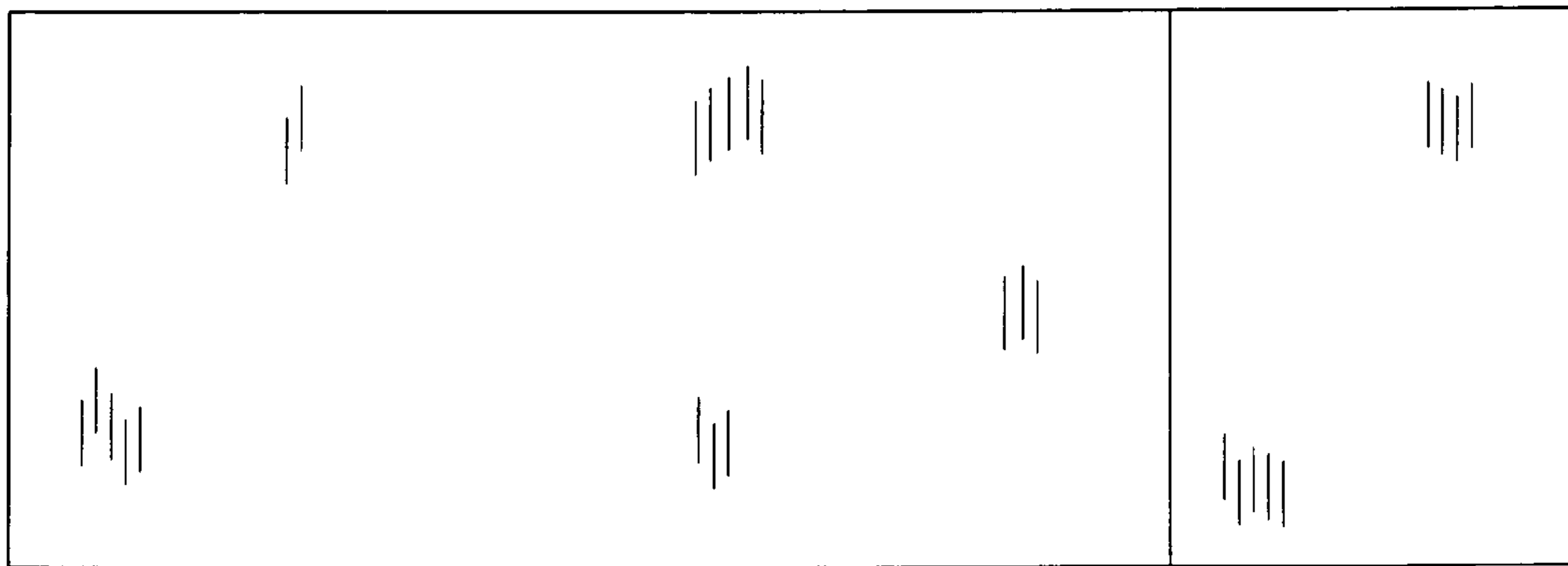

Fig. 2

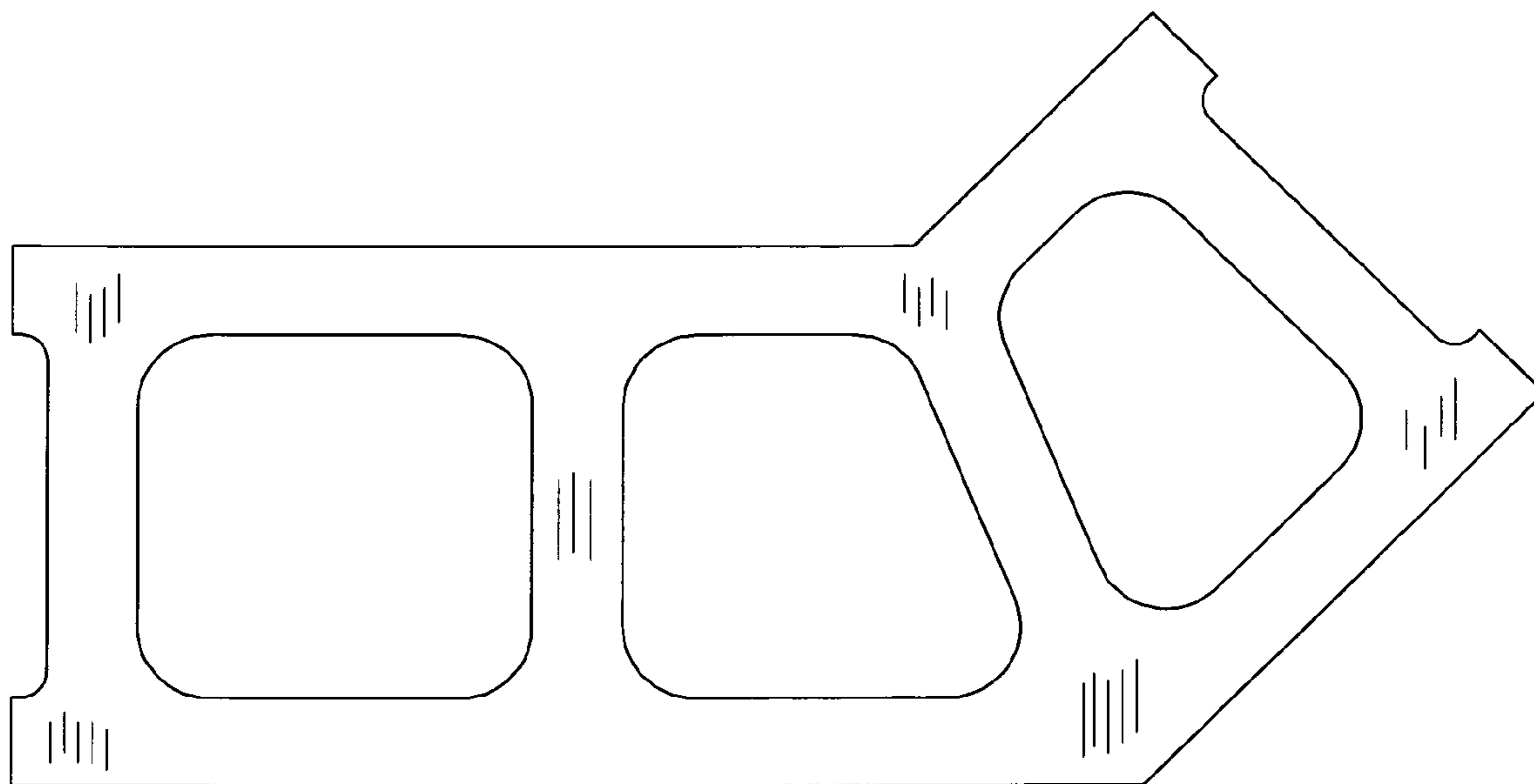

Fig. 3

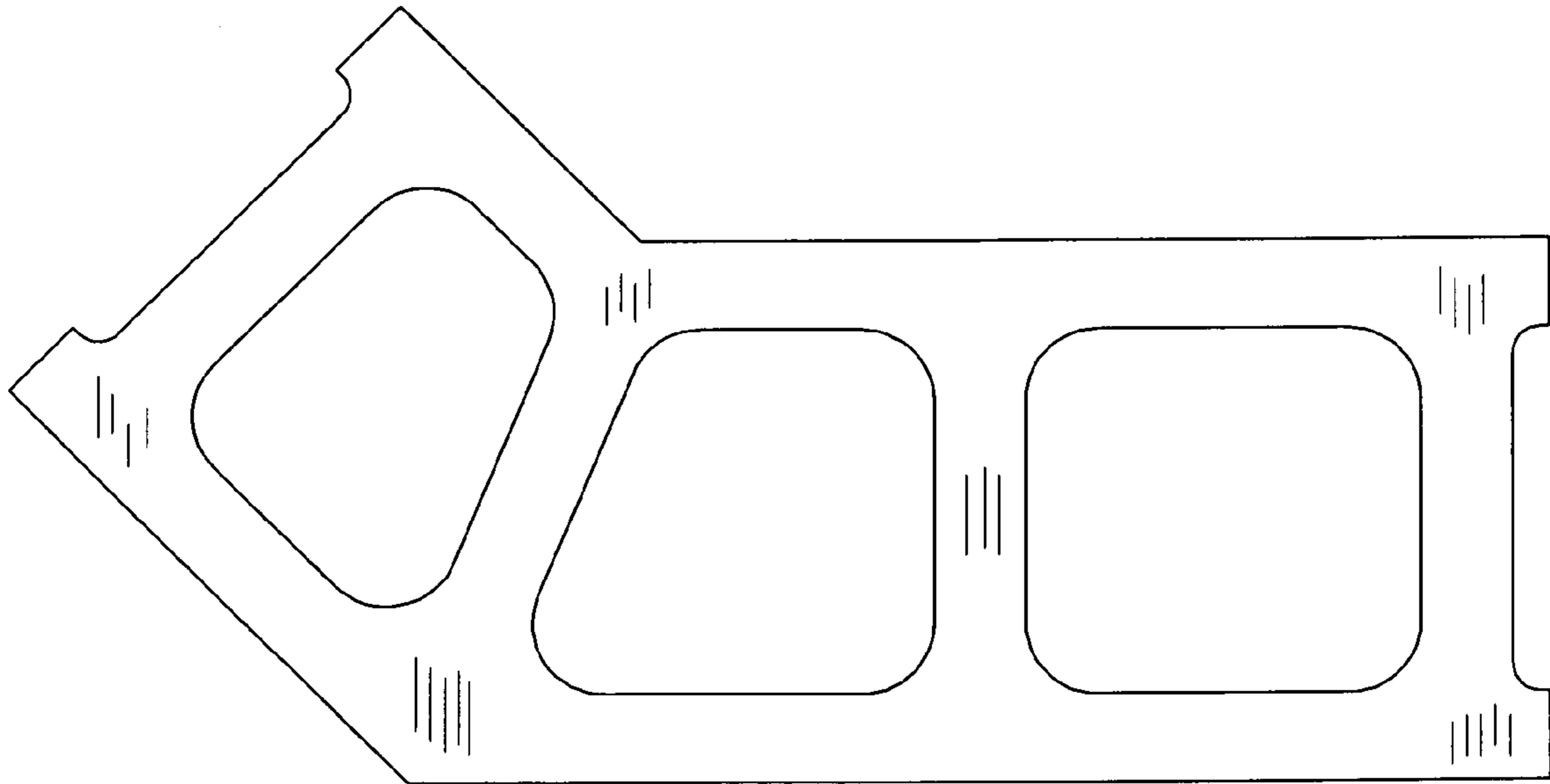

Fig. 4

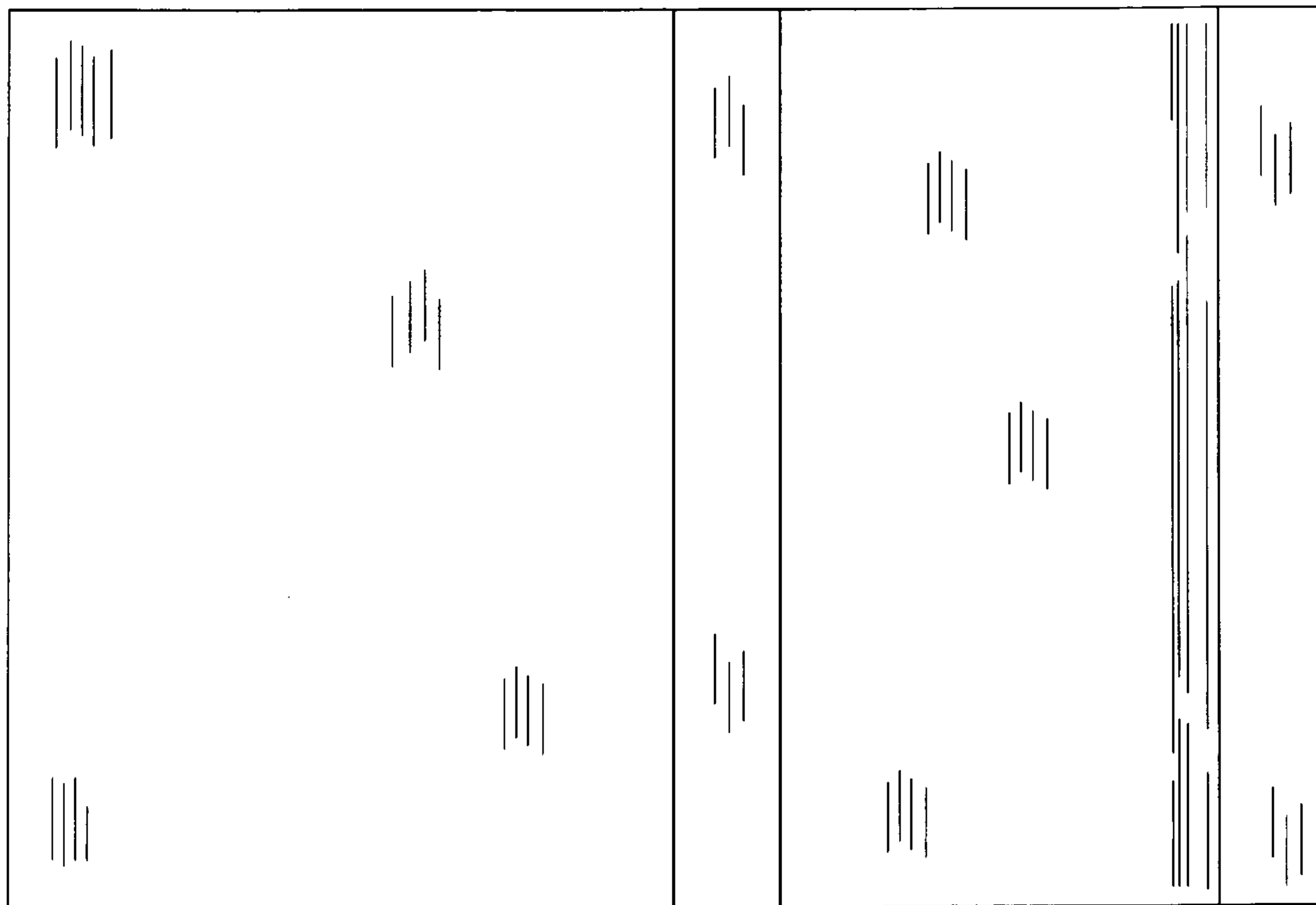

Fig. 5

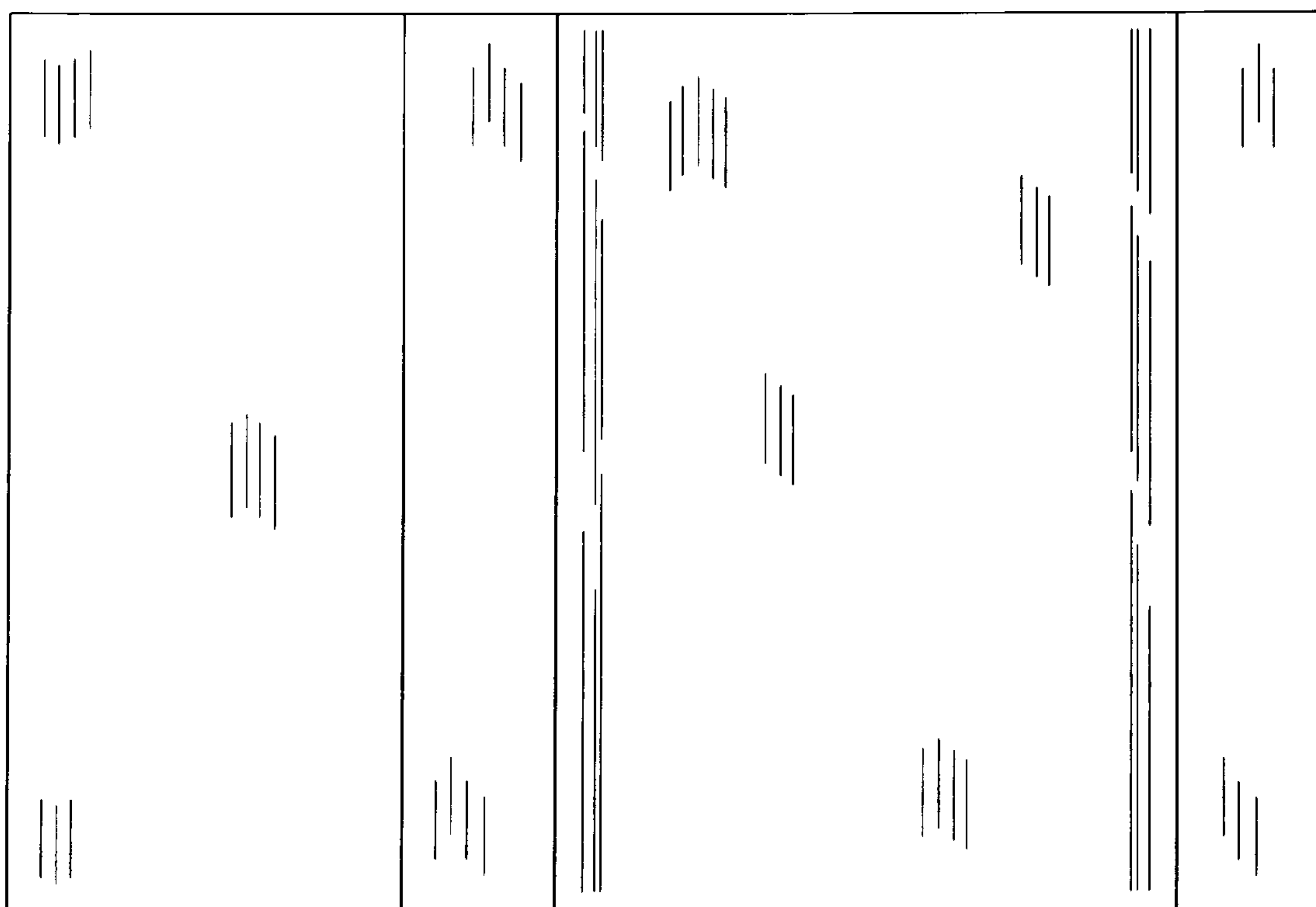

Fig. 6

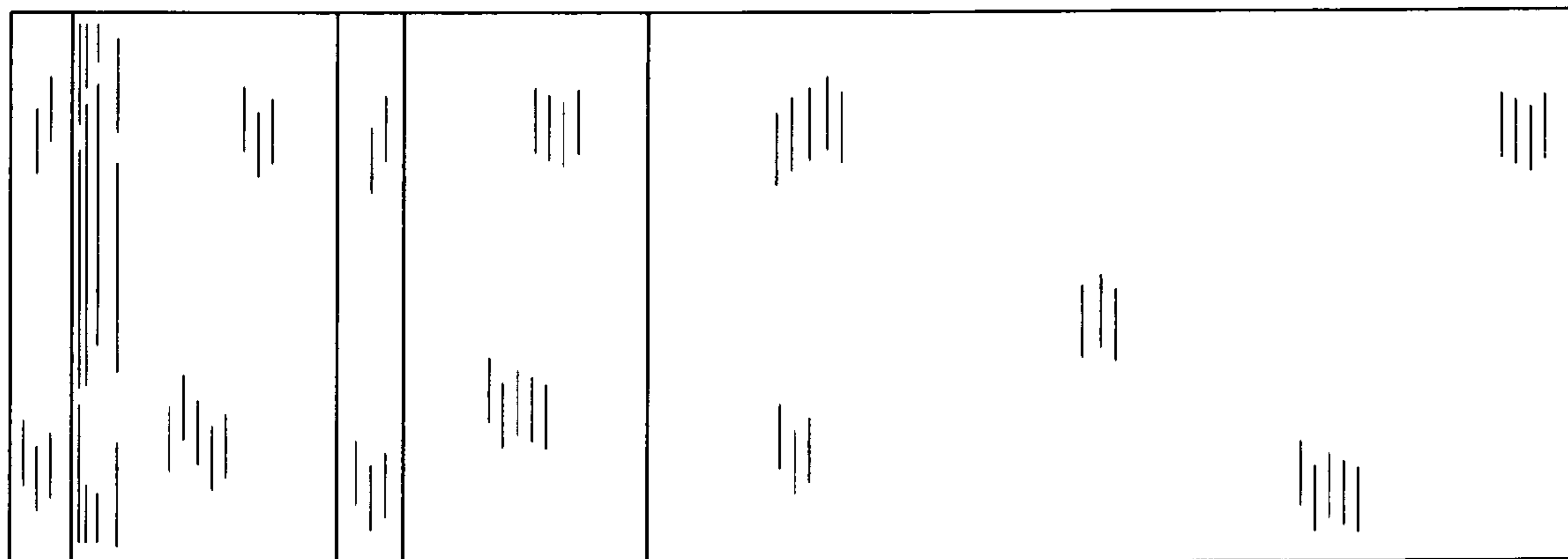

Fig. 7